

MOOER

Stereo Cabinet Simulation Pedal

Owner's Manual

Content

Precautions-----	01
Features-----	02
Top panel-----	03-07
Instructions-----	08-09
Recommended setup-----	10-13
CAB X2 editor software-----	14-19
Effect list-----	20
Specification-----	21

Precautions

PLEASE READ CAREFULLY BEFORE PROCEEDING

Power Supply

Please connect the designated AC adapter to an AC outlet of the correct voltage. Be sure to only use an AC adapter which supplies 9V DC, 300mA. Unplug the AC power adapter when not in use or during electrical storms.

Location

To avoid deformation, discoloration, or other serious damage, do not expose this unit to the following conditions:

- Direct sunlight or other heat sources
- Excessively dusty or dirty locations
- High humidity or moisture
- Magnetic fields
- Strong vibrations or shocks

Radio Frequency Interference

Radios and televisions placed nearby may experience reception interference. Operate this unit at a suitable distance from radios and televisions.

Cleaning

Clean only with a soft, dry cloth. If necessary, slightly moisten the cloth. Do not use abrasive cleanser, cleaning alcohol, paint thinners, wax, solvents, cleaning fluids, or chemical-impregnated wiping cloths.

Features

- High-quality IR loading stereo cabinet simulation pedal
- Includes 14 user preset slots that can store two different cabinet simulation settings each
- 11 factory cabinet simulation files with support for loading third-party impulse response files
- Choose between mono or stereo setups
- Footswitch can be assigned as a tradition on/off switch or to switch between presets
- Dual inputs (stereo) and outputs (stereo) for stereo/mono setup
- Comes with a specialized editor software for preset management and IR loading

Top panel

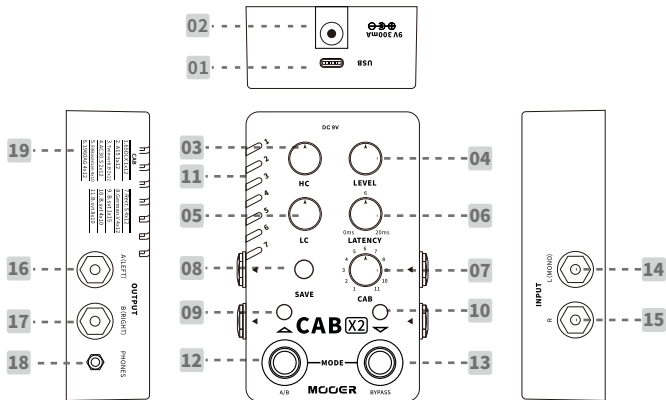

01. TYPE-C USB port:

Connect to computer editor software to manage preset, loading IR and firmware update.

02. DV 9C

Connect to center negative power supply with 9V and at least 300mA current draw.
Recommend to use the original power supply to avoid unexpected noise.

03. HIGH CUT

High frequency cut adjustment (Range from 3kHz to 20kHz)

04. LEVEL

Volume level adjustment

05. LOW CUT

Low frequency cut adjustment (Range from 25Hz to 500Hz)

06. LATANCY

Latency value adjustment from 0 to 20ms.

07. CAB

Select cabinet simulation from 11 factory setting files.

08. SAVE

Press to switch between 1-14 preset slots, press and hold to confirm saving preset.

09. Left footswitch LED:

Indicate the current cab sim is type A or type B. Blue for A, RED for B.

10. Right footswitch LED:

Indicate the on/off status of the pedal. BLUE LED for on, LED off for off.

11. Preset LED:

Indicates currently selected preset slot.

12. Left (A/B) footswitch:

Press to switch A/B cab sim

13. Right (BYPASS) footswitch:

Press to switch on/off the currently selected cab sim

14. INPUT-L (MONO):

1/4" unbalanced (TS) monoaural output jack. Please utilize this jack for mono input set up (It is the left input of the stereo setup)

15. INPUT R

1/4" unbalanced (TS) monoaural output jack (It is the right input of the stereo setup)

16. OUTPUT A (Left)

1/4" unbalanced (TS) monoaural output jack, left cab sim analog output jack

17. OUTPUT B (Right)

1/4" unbalanced (TS) monoaural output jack, right cab sim analog output jack

18. PHONES

1/8" stereo audio headphone output jack

19. Factory cab list

Factory cabinet simulations list

*** The regular frequency range of high and low cut**



Low frequency cut 80HZ~100Hz

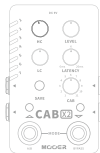

High frequency cut 10kHz



High frequency cut 8kHz

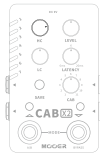

High frequency cut 6kHz

Instructions

Select Preset

Press SAVE button to scroll through the 14 preset slots; Or you can press two footswitches simultaneously to enter preset select mode, the LED of both footswitches, the LED of SAVE button will blink in RED. In this mode, press left/right footswitch to scroll up/down the 14 presets.

The preset select mode will exit and be back to normal mode if idle for more than 3 seconds. In normal mode, the LED of both footswitches and SAVE button will stay on.

Tone adjustment for left/right output

Each preset can store the cab sim models, parameters the of left output and right output individually. Press the left footswitch to switch the A (left) output and B (right) output. The color of the LED button indicates the currently selected output. Blue means the left output is selected while red means the right output is selected. The controllable parameters include LEVEL, TYPE, LATENCY, LOW CUT, HIGH CUT and CAB.

In the normal footswitch mode, press right footswitch to turn on/off the cab sim of left/right output.

The PRESET LED will blink when preset parameter changes and have not been saved.

Save Presets

Press and hold the SAVE button for 2 seconds to save the currently edited parameters. The button LED will blink to confirm saving is complete.

Factory Reset

Unplug the power cord then press and hold the SAVE button while plugging in the power cord to power on the unit. The PRESET LED will start to blink. Release the button and wait for the LED to start blinking to confirm the reset was successful. This operation can be cancelled by powering off the pedal before releasing the SAVE button.

Notice: Factory reset will clear all user files, including the third-party impulse response files.

Recommended setup

Pedalboard Mono Setup

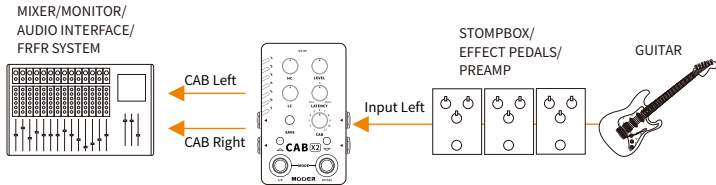

Pedalboard Stereo Setup

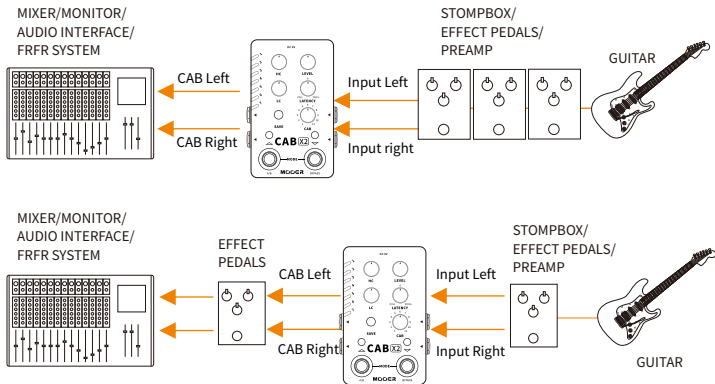

Multi-Effect Setup

MIXER/MONITOR/
AUDIO INTERFACE/
FRFR SYSTEM

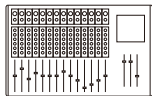

CAB Left

CAB Right

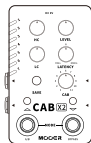

Input Left

Input Right

MULTIEFFECTS BOARD

GUITAR



MIXER/MONITOR/
AUDIO INTERFACE/
FRFR SYSTEM

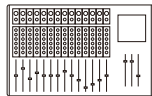

Return

MULTIEFFECTS BOARD



SEND

GUITAR



MULTIEFFECTS BOARD FX LOOP

FX LOOP with Amplifier

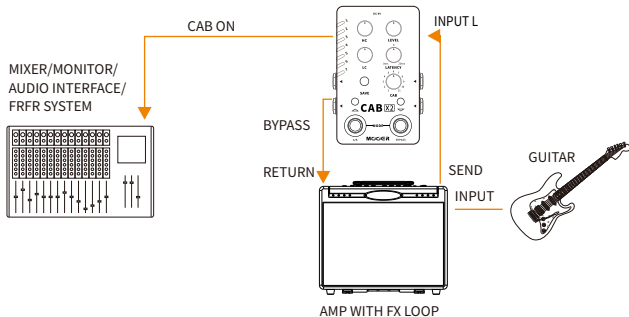

Notice: In this setup, we recommend setting the output connecting to the amplifier to bypass the cab sim. The other output connecting to the mixer/FRFR system should have the cab sim on.

CAB X2 editor software

CAB X2 supports computer editor software. Users can quickly adjust parameters, manage presets, load impulse response files, backup users files, etc..

Download

Visit the official MOOERAUDIO website (<http://www.moeraudio.com/download.html>) and download the software version that matches the operating system (OS) of your computer. OS requirements: Win7 or higher, Mac OS 10.11 or higher.

Connection

After finishing the installation, connect your CAB X2 to your computer using the USB cable that comes with the unit. Open the CAB X2 EDIT software and select the icon on the top right corner to confirm connection.

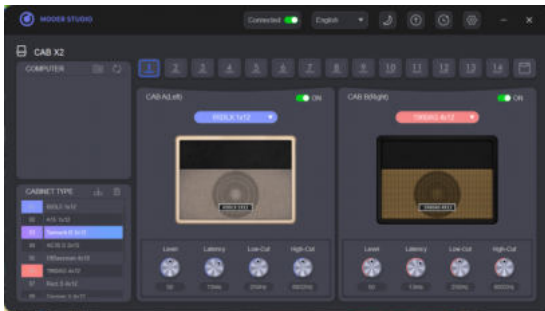

In the CABINET TYPE area in the left bottom, there are two different colors. Blue represents the left output signal while Red represents the right output signal.

Select Preset

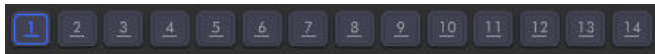

Click on the numbers to switch to the relevant preset patch.

Select Cabinet Simulation

Click on the drop-down menu under the cab picture to view and select cab sim.



Select desired cabinet simulation on the right side. Right click a desired cab sim model, decide if it is set to left output or right output in the pop up window.

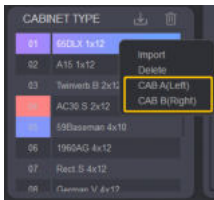

Preset Saving

Click on the  icon to save the currently selected preset.

Preset Management

Export Preset: Drag the number on the right-top PRESET(Device) area to the COMPUTER area to export the preset file from the CAB X2 to the computer.

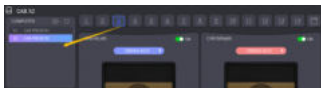

Import Preset: Drag the preset from the COMPUTER area to the desired number on the PRESET (Device) area to import the preset file from the computer to the CAB X2.

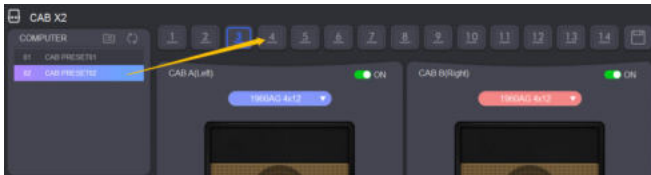

Click on the  icon in the COMPUTER area to open the target folder of preset files in your computer.

Notice: 1. Put the preset files into this folder and click the  icon. Those preset files will be shown in the COMPUTER area of the software.
2. Preset files do not include third-party impulse response files.

Firmware/software update

Click on the  icon to update the firmware or editor software. After firmware update is done, the CAB X2 will reboot automatically.
For editor software update, it will switch to the download center of MOOERAUDIO official website, you can download the software on the software download page and install it.

Factory Reset

Click on the  icon to enter factory reset menu. A confirmation window will pop up, click on Yes to confirm reset. The CAB X2 will reboot automatically after reset is done.

Notice: Factory reset will clear up all the preset patches and third-party IR files.

Backup/Restore

Select the  icon, click on the button to backup all preset files in your CAB X2. Select the target location to start backing up files. The preset files will be packaged into a single .bfl file.

Notice: This backup file ".bfl" includes impulse response files.

Effect list

Name	Description
65DLX 1×12	Based on Fender® 65 Deluxe reverb 112 cabinet
A15 1×12	Based on VOX® AC15C1 112 cabinet
Twinverb.B 2×12	Based on Fender® 67 Twin Reverb Blackface 212 cabinet
AC30.S 2×12	Based on VOX® AC30 212 cabinet
59Baseman 4×10	Based on Fender® 59 Bassman 410 cabinet
1960AG 4×12	Based on Marshall® 1960A Green Back 412 cabinet
Rect.S 4×12	Based on Mesa Boogie® Recto Standard 412 cabinet
German.V 4×12	Based on Diezel® Rear loaded V30 412 cabinet
B.svt 1×15	Based on Ampeg® svt 15E 115 cabinet
B.svt 4×10	Based on Ampeg® svt 410HE 410 cabinet
B.svt 8×10	Based on Ampeg® svt 810E 810 cabinet
*NOTES: All product names belong to their owners and are only used in this product and manual as a reference to tone types.	

Specification

Input: 2*1/4" monoaural jack (Impedance value: 1M ohms)

Output: 2*1/4" monoaural jack (Impedance value: 510 ohms),
1*1/8" stereo audio output jack (Impedance<1 Ohms)

Power supply: 9V DV center negative (Please ensure the voltage value of power supply is not more than 9V, ensure the polarity is correct.)

Current Draw: 300mA

Dimension: 75x115x33mm

Weight: 0,334 kg

Accessories: Owner's manual, USB TYPE-C to TYPE-A cable; DC 9V power supply,
Quick guide, Sticker

Format: WAV

SampleRate: 44.1kHz (support loading file with different sample rate)

SampleAccuracy: 24 bit

SampleLength: 2048*2

MOOER
www.moeraudio.com

SHENZHEN MOOER AUDIO CO. LTD
6F, Unit D, Jinghang Building, Liuxian 3rd Road,
Bao'an 71 District, Shenzhen, China. 518133
Made in China