

MOOER

GE1000 / GE1000 Li
Intelligent Multi-Effects

Owner's Manual

CONTENT

PRECAUTIONS.....	1
FEATURES	2
CONTROLS	3
CONNECTIONS.....	4
TERMINOLOGY	5
CONNECTION SCENARIOS	6
Connection to Full-Range equipment	6
Connection to a guitar power amplifier and cabinet	6
Mixed full-range / non-full-range device connection	7
Four-Wire connection	7
QUICK START	8
Start up.....	8
Main user interface	8
Stage View	8
Edit View.....	9
Preset selection	10
Bank Switching	10
Shut down	10
OPERATION.....	10
Preset editing	10
Preset composition.....	10
Adding effects.....	11
DSP resources	11
Activating / deactivating effects.....	12
Changing effect positions	12
Removing effects.....	13
Parameter editing.....	14
Changing the effect model/type	15
Preset volume.....	15
BPM tempo.....	15
Saving presets.....	17
AI Equalizer	18
CTRL Mode	18
Activating the CTRL mode	19
Assigning CTRL functions.....	19
Stompbox mode	20
Single mode	20
Multiple mode	20

Sub Patch mode.....	21
1. Mapping a parameter to a Sub Patch.....	21
2. Configuring the effect module switching status for a Sub Patch	22
3. Modifying / deleting parameter settings in a Sub Patch.....	22
4. CTRL priority setting	23
5. Renaming and clearing a Sub Patch:	23
Expression Pedal.....	24
Pedal calibration.....	24
Use as Master Volume / Expression Pedal	25
Expression parameter mapping	25
Remove expression mappings.....	26
Volume Pedal Settings.....	27
Toe switch mapping	27
USING EFFECT LOOPS	28
Connecting a single effect pedal	28
4-Wire connection method	30
Extended input and output options	32
TUNER.....	33
Tuner screen.....	34
Tuning.....	34
Exit tuning mode	34
GROOVE STATION	35
Open the Groove Station.....	35
Groove Station screen	35
Drum Machine.....	36
Looper.....	36
Looper Auto Record.....	36
Drum synchronization	36
Close the Groove Station.....	37
USB DIGITAL AUDIO.....	37
Parameter descriptions	37
Mode descriptions.....	38
BLUETOOTH AUDIO	40
GLOBAL SETTINGS	40
Global input settings	40
Global output settings.....	41
1. Global output volume.....	41
2. Global equalization adjustment	41
3. Other function switches	42

Screen Brightness	42
Bank switch timeout.....	43
Stage View display.....	43
Tap Tempo.....	43
Bank Switch Mode.....	44
Priority Mode	44
Volume Pedal Position	44
Spill-Over (Effect Trails).....	44
Language Selection.....	45
Factory reset.....	45
MIDI.....	46
Supported MIDI commands	46
GE1000 as controlled device	46
MIDI Channel.....	46
CC Mapping	46
PC mapping.....	48
Other settings.....	49
GE1000 as controlling device	50
MIDI Channel.....	50
PC mapping.....	50
Other settings.....	51
F4 WIRELESS FOOTSWITCH	52
Configuring the wireless footswitch.....	52
Available functions for the wireless footswitch	53
MOOER STUDIO SOFTWARE & CLOUD APP	54
MOOER STUDIO Software	54
Firmware update	54
GNR file import.....	55
GIR/IR import.....	55
Data backup.....	55
Parameter editing interface	56
Preset management	56
Preset editing	56
Expression pedal settings	56
Preset volume level and BPM settings.....	57
Input & Output Settings	57
Global Settings.....	57
TROUBLESHOOTING	57
SPECIFICATIONS.....	58

ANNEX 1: EFFECT DESCRIPTIONS	60
Dynamic modules	60
Filter modules.....	61
Overdrive modules	62
Amplifier modules	63
Poweramp Modules	66
Cabinet modules.....	66
Equalizer modules	68
FX Loop module.....	70
Modulation modules	70
Time delay modules	72
Reverb modules.....	73

PRECAUTIONS

PLEASE READ CAREFULLY BEFORE PROCEEDING

Power supply

Please use a manufacturer-approved power supply adapter supplying 9 VDC, 1000 mA (3000 mA for GE1000 Li), and center negative polarity. 

Only use power supplies that have been approved by the relevant authorities and that meet UL, CSA, VDE or CCC standards. Unplug the power adapter when not in use or during electrical storms.

For GE1000 Li:

Prevent the device, which contains a battery, from overheating (e.g., keep it out of direct sunlight and away from heat sources, etc.). Should the battery leak, prevent the liquid from getting into contact with skin or eyes. In case of contact with the liquid, consult a doctor. The battery supplied with this product may pose a risk of fire or chemical burns if not handled properly.

Cleaning

Clean only with a soft, dry cloth. If necessary, lightly moisten the cloth. Do not use abrasive cleaners, cleaning alcohol, paint thinners, wax, solvents, cleaning fluids, or chemical-impregnated wiping cloths.

Connections

Always turn off / disconnect the power to the GE1000 and any other equipment before connecting or disconnecting signal cables. This will help prevent malfunctions and / or damage to other devices. Also make sure to disconnect all connection cables and the power supply before moving the device.

Operation

- Please do not use excessive force to operate the control elements of the unit.
- Prevent metal, paper or other objects from getting into the unit.
- Please do not drop the unit, and avoid heavy blows.
- Please do not modify the unit without authorization.
- Should repairs be required, please contact the MOOER Customer Service Center for more information.

Storage and usage locations

To avoid deformation, discoloration or other serious damage, do not expose this device to any of the following conditions:

- direct sunlight
- extreme temperature or humidity
- excessively dusty or dirty locations
- magnetic fields
- high humidity or moisture
- strong vibrations or shocks

FCC certification

This device complies with Part 15 of the FCC Rules. Operation is subject to the following two conditions:

- This device may not cause harmful interference.
- This device must accept any interference received, including interference that may cause undesired operation.

Interference with other electronic devices

Radios and televisions placed nearby may experience interference with reception. Operate this device at a suitable distance from radios and televisions.

FEATURES

- New member of MOOER GE series, using the new Walking Star design language
- Choice between a traditional version (GE1000) and a version with integrated 7.4 V / 4750 mAh Li-Ion battery (GE1000 Li) for use without a power cable
- Large 5" high-quality touch screen with intuitive UI, delivering brand-new multi-effect experience
- 85 storage banks with 3 presets each, providing a total of 255 storage spaces for presets
- Innovative AI equalization master can provide inspiration for tone adjustment according to the style of music
- Extensive I/O options provide flexibility for studio, stage and practice applications
- Stereo outputs and switchable parallel / serial stereo FX loop to add external pedals to the chain of effects
- Quick-access physical effect block buttons typical for the GE family
- On-board EXP1 pedal can be configured as volume control or expression pedal
- Supports wireless footswitch of the MOOER F4 series for extended control options
- Including Groove Station mode with Drum Machine and Looper that can be synchronized; the perfect tool for creativity and practice
- Precise built-in instrument tuner
- Tap tempo control for tempo-based effects and Drum Machine
- Adjustable Global EQ settings plus adjustable input and output levels for easy integration in any setup and great results with all different kinds of instruments and venue configurations
- Supports audio playback from mobile devices via Bluetooth
- Programmable MIDI ports for MIDI IN or MIDI OUT to allow control from external devices or to control other devices
- Type-C port:
 - Professional low-latency ASIO USB audio interface (Type-C) supports up to 192 kHz sample rate, providing a one-stop solution for professional musicians
 - USB MIDI function
 - Firmware updates via PC software

CONTROLS

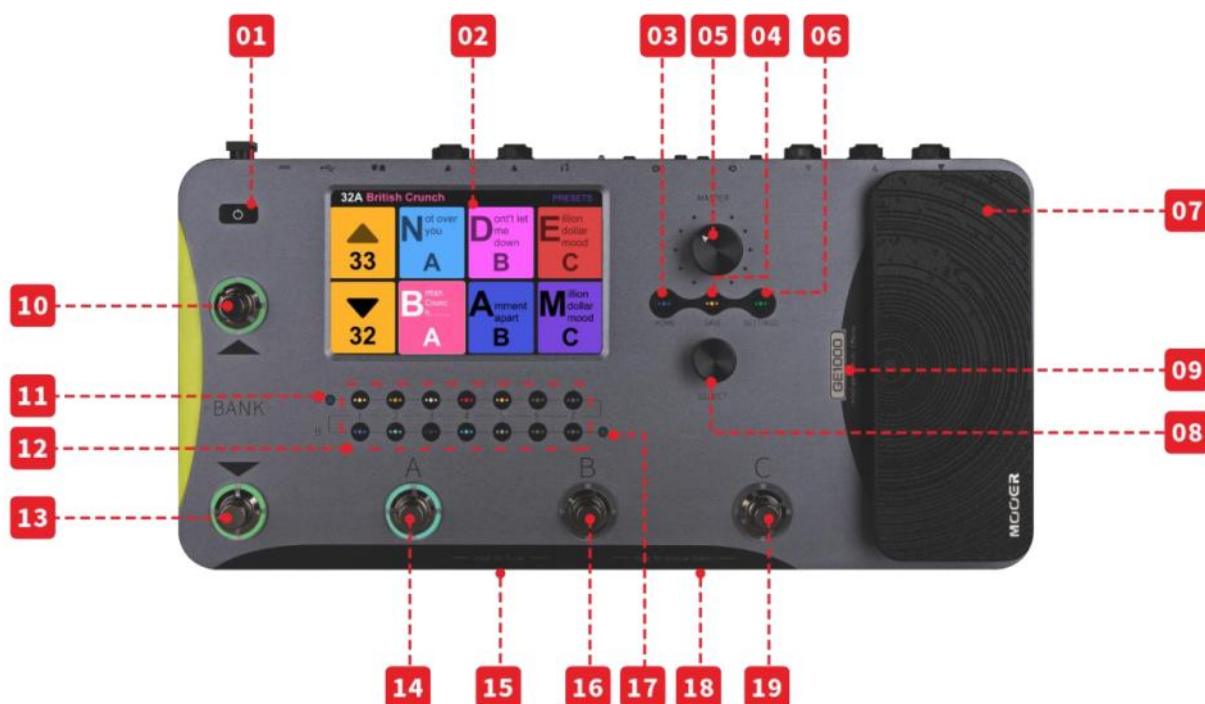

1. **Power switch:** Press and hold to turn the device on/off.
2. **5-inch LCD touch-screen:** Shows presets, parameters and statuses and allows full operation of all features using touch commands.
3. **Home button:** Press to return to the main user interface.
4. **Save button:** Press to save your settings in a preset.
5. **Master knob:** Rotate to adjust the total output volume.
6. **Settings button:** Press to open the settings page.
7. **EXP1 pedal:** Can be configured as volume or expression pedal. (See [EXPRESSION PEDAL](#))
8. **Select knob:** Encoder for fine-tuning parameters selected on the touch screen. Press to restore the respective default values.
9. **Logo LED:** Indicates the status of the EXP1 pedal. The pedal works as **Expression** pedal when the logo is lit and as **Volume** pedal when the logo is not lit.
10. **Bank ▲ footswitch:** Press to scroll up between preset banks.
This switch is also used for exiting the CTRL mode. (See [CTRL MODE](#))
11. **Input level indicator:** Real-time indication of input signal level.
12. **Effect module LED buttons:** The buttons correspond to the effect positions in the effect chain on the screen. Press a button to open the parameter editing screen for the corresponding module. Double-press to activate / deactivate the module.
13. **Bank ▼ footswitch:** Press to scroll down between preset banks.
- in CTRL Mode: switch between Stompbox Mode and Sub Patch mode. (See [CTRL MODE](#))
- in Groove Station mode: Looper REC / PLAY / DUB / UNDO / REDO (See [GROOVE STATION](#))
14. **Footswitch A:**
- in Preset mode: switches to Preset A in the selected bank
- press again to enter CTRL mode
- in CTRL mode: executes pre-programmed control function (See [CTRL MODE](#))
- in Groove Station mode: Looper Stop / Clear (See [GROOVE STATION](#))
15. **Footswitches A + B simultaneously:** Hold both footswitches to open Tuner mode. (See [TUNER](#))
Tap any footswitch to exit Tuner mode.
16. **Footswitch B:**
- in Preset Mode: switches to Preset B in the selected bank
- press again to enter CTRL mode
- in CTRL mode: executes pre-programmed control function (See [CTRL MODE](#))

- in Groove Station mode: Tap Tempo control for Drum Machine BPM (See [GROOVE STATION](#))
- 17. **Output level indicator:** Real-time indication of output signal level.
- 18. **Footswitches B + C simultaneously:** Hold both footswitches to open Groove Station Mode. (See [GROOVE STATION](#))
- 19. **Footswitch C:**
 - in Preset mode: switches to Preset C in the selected bank
 - press again to enter CTRL mode
 - in CTRL mode: executes pre-programmed control function (See [CTRL MODE](#))
 - in Groove Station mode: starts /stops the Drum Machine (See [GROOVE STATION](#))

CONNECTIONS

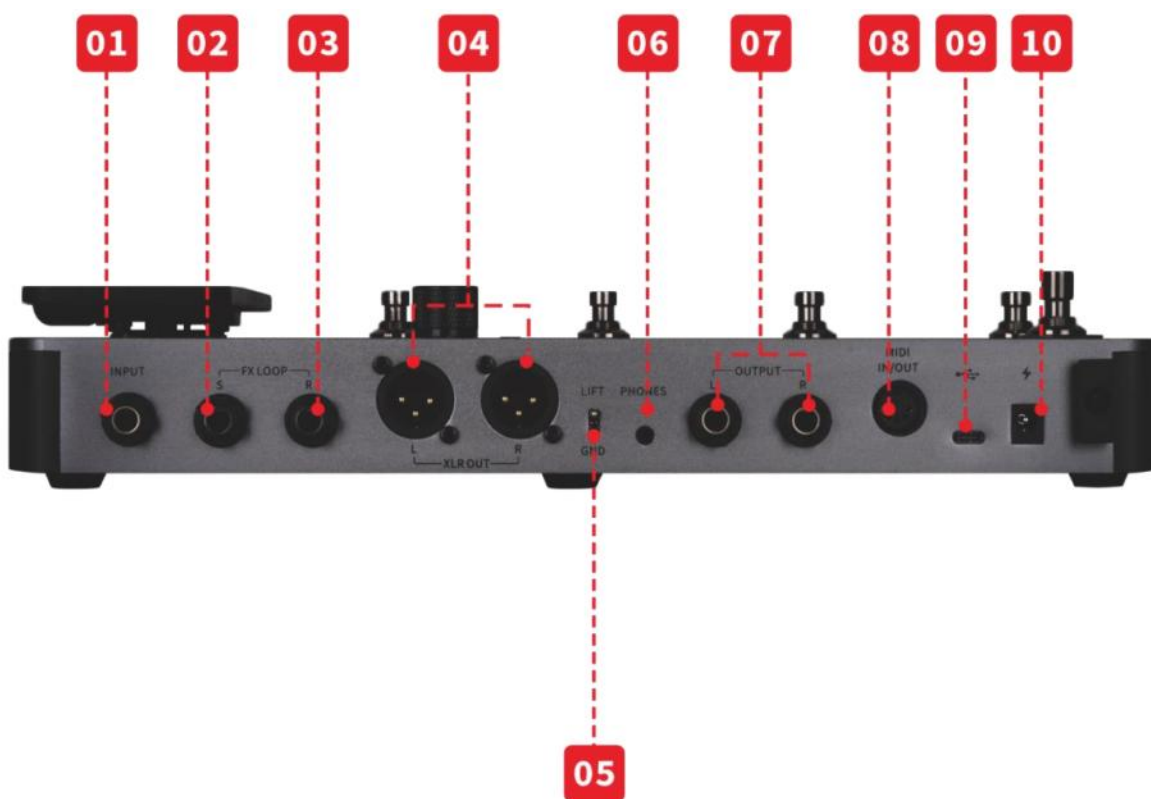

1. **INPUT:** 1/4" mono audio jack, input for guitar or bass.
2. **FX SEND:** 1/4" stereo audio jack, connection to the input of external effects. Connecting an external stereo device requires the use of a TRS to double-ended TS adapter cable (shown below).
3. **FX RETURN:** 1/4" stereo audio jack, connection from the output of external effects. Connecting an external stereo device requires the use of a TRS to double-ended TS adapter cable (shown below).



(TRS to double-ended TS adapter cable)

4. **XLR output connectors (left/right):** Balanced output signal for monitor systems, sound card, mixing consoles or similar equipment.
5. **GND / LIFT switch:** Ground switch. Try using this switch if you experience low frequency hum. Flipping this switch to the opposite position may help solving ground loop problems.
6. **PHONES:** 1/8" stereo headphone output jack

7. **OUTPUT jacks (left / right):** 1/4" mono audio jacks (unbalanced). Connection to the input Jack of active speakers, other effects, amps or other audio devices.
8. **MIDI IN/OUT:** 5-PIN MIDI connector. Use a 5-PIN MIDI cable to connect to an external device that can control the GE1000 or a device that can be controlled by the GE1000.
9. **USB Type C interface:** Connection to a computer for USB audio functions or to use the supporting software (See [USB DIGITAL AUDIO](#), see [MOOER STUDIO Software](#))
10. **9 V power input:** Connect the supplied power supply adaptor.

TERMINOLOGY

This section explains the terminology used in the manual. Understanding the terminology will help you understand the contents of the manual.

Preset:

- A pre-programmed sound configuration, usually including settings for effects used in the effects chain and their parameters as well as volume and expression settings.
- A preset is stored in a storage slot indicated by a bank number (1 - 85) followed by a preset letter (A-C). The 3 presets in each bank can be selected with the A, B or C footswitches.

Effects chain:

- The sequence of effects a signal has to pass through within the GE1000 to get from the input to the output.

Effect module:

- The general category of effects models that can be positioned in the effects chain, such as AMP (amp modules), CAB (cabinet simulation modules), REVERB (reverb modules), DYNA (dynamic effects) and so on.

Effect type:

- A specific effect within an effect category, such as "Red Compressor" in category "DYNA".

Effect slot:

- An empty position in the effects chain shown as a . Click the symbol to load an effect in this position.

Stage View:

- Main interface mode showing information that facilitates stage performance and highlights preset numbers and names to provide for good visibility.

Edit View:

- Main interface mode for sound editing, showing the selected preset, the composition of the effects chain, the status of effect modules in the chain, the preset-based volume level, the current BPM settings and input/output levels. It also shows the battery status for the GE1000 Li.

Control mode (CTRL):

- Mode for directly controlling the on/off status and parameters of one or several effect modules in the effects chain or the tap tempo for selected parameters using the footswitches in the lower row. These footswitches can each be individually programmed for their specific CTRL function. (See [CTRL Mode](#))

Groove Station:

- Mode that combines controls for a drum machine and phrase loop functions. Drum Machine and Looper can also be synchronized in this mode. (See [GROOVE STATION](#))

CONNECTION SCENARIOS

Connection to Full-Range equipment

This connection scenario includes full-range equipment such as studio monitors, sound cards, active stage monitors, PA systems (full-range/crossover amplifiers + full-range/crossover speakers), headphones, and other full-range equipment. When you establish connections using this application scenario it is recommended to activate AMP and CAB modules in order to achieve a professional guitar sound. Please refer to the following diagram for connections:

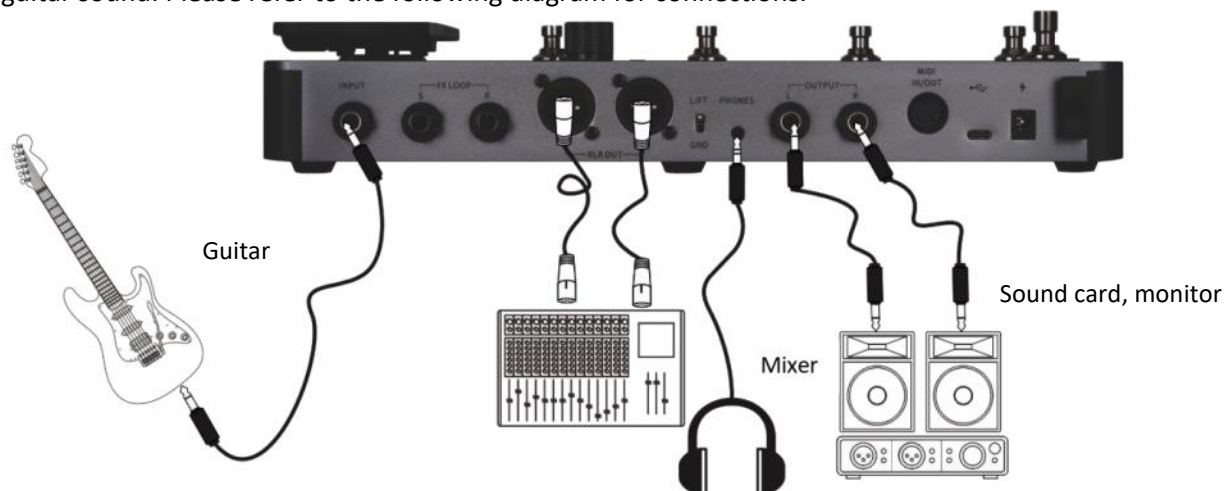

Note: The 1/4" or the XLR output connectors can both be used for the connections in this scenario. XLR balanced outputs can provide a more suitable signal for long cable routes and are less susceptible to interference than unbalanced 1/4" outputs. Please connect according to your actual needs.

Connection to a guitar power amplifier and cabinet

This connection scenario includes a guitar amplifier with FX LOOP or a pure power amp. It is recommended to activate the AMP module when you establish connections using this application scenario. All preamp functions will be performed by the GE1000 in this case. Please refer to the following diagram for connections:

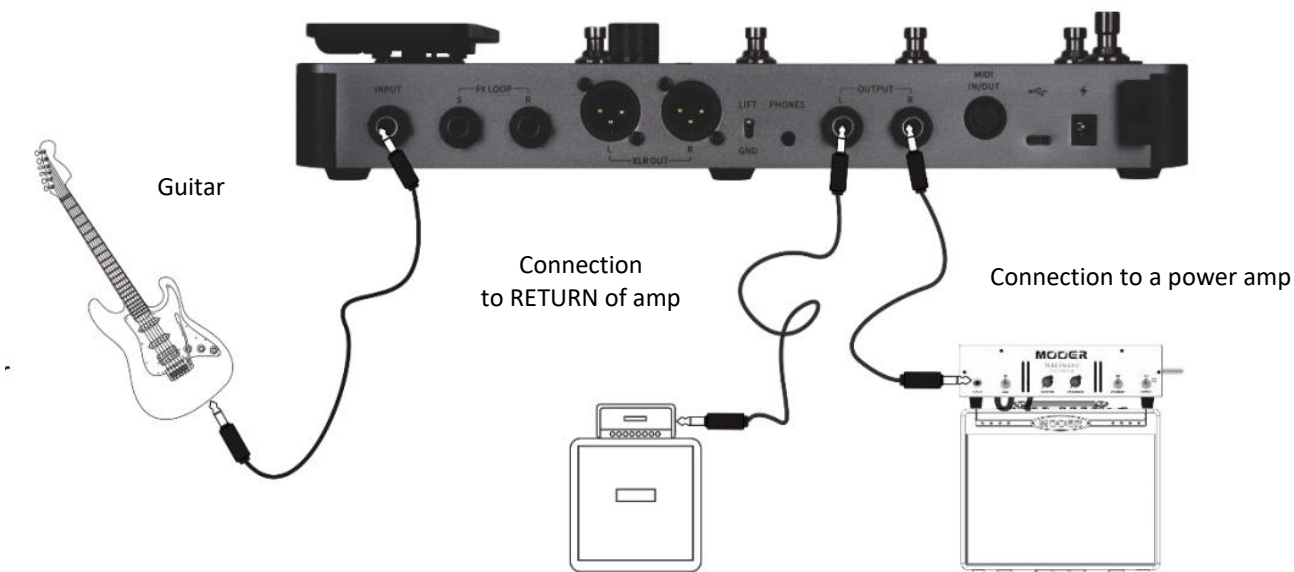

Mixed full-range / non-full-range device connection

This connection combines the two scenarios above, when you need to use full-range equipment (e.g. mixers) and non-full-range equipment (e.g. guitar amps and cabinets) at the same time. Please refer to the following diagram for connections and activate the **1/4" GLOBAL CAB** and **GLOBAL POWER AMP** bypass switches in the output settings. (See [Global output settings](#))

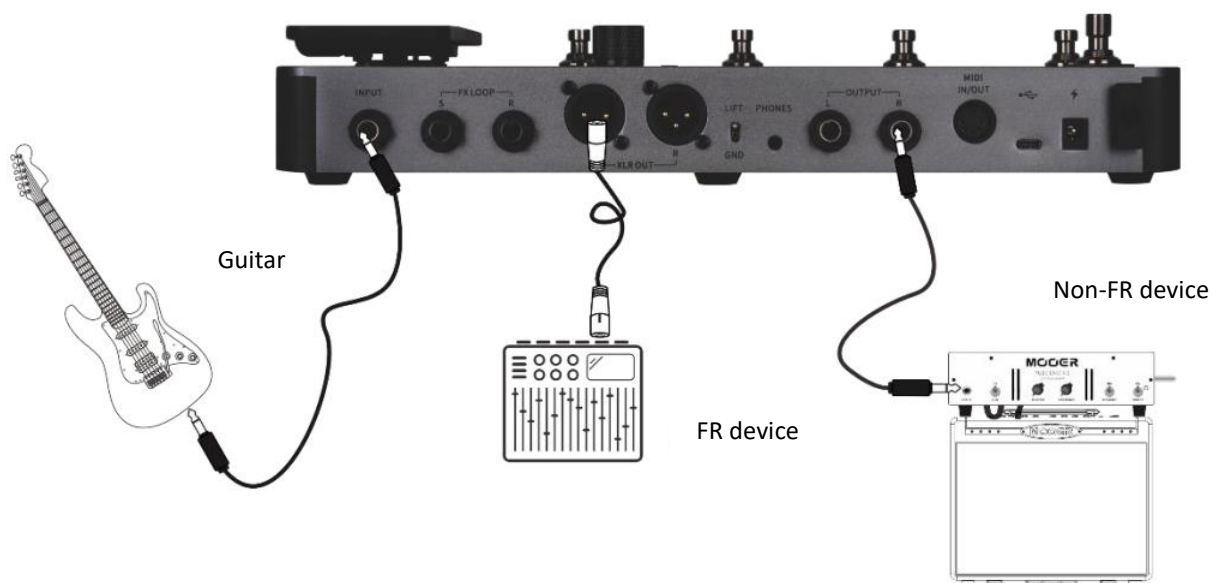

Four-Wire connection

The GE1000 supports connections to a guitar amp equipped with an FX LOOP using the "4-wire method". This way, the preamp section of a physical amp can be positioned in the effect chain of the GE1000 using the **Send / Return** modules and the output of the GE1000 can then be run through the power amp section of the same amplifier. Please refer to the following diagram for connections:

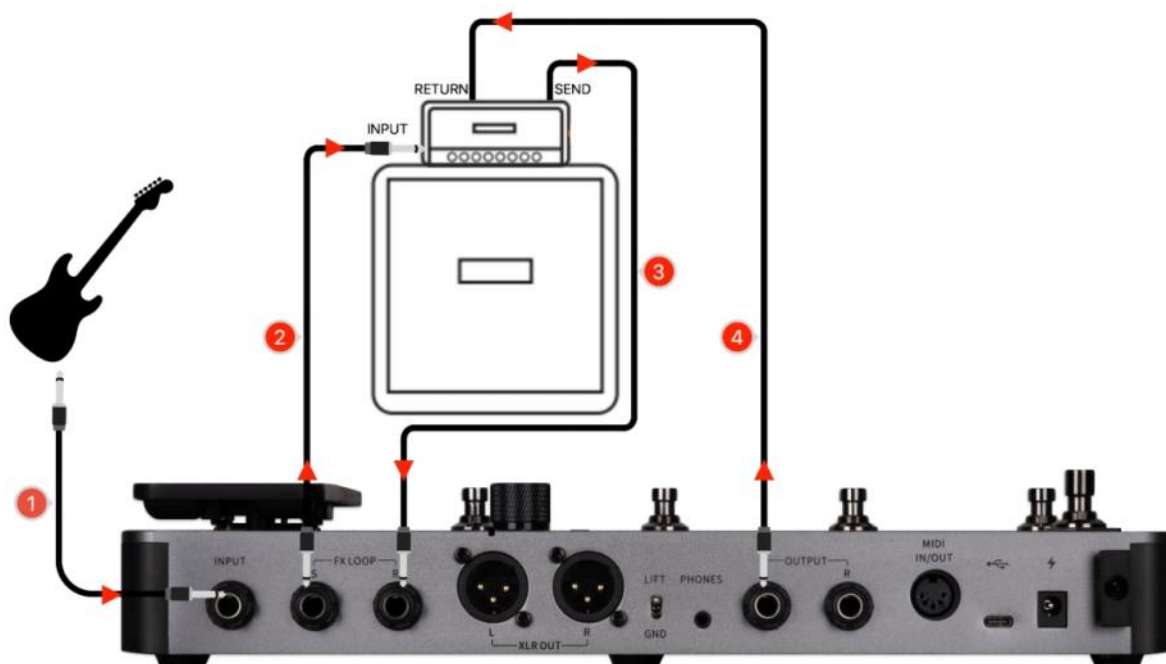

See [USING EFFECT LOOPS](#) for further information.

QUICK START

Start up

- Connect the **inputs and outputs** of the device as required according to the connection scenarios above.
- Turn the **MASTER volume** knob down to minimize the output volume.
- Connect the **power supply** (the GE1000 Li can operate on battery power)
- Press the **Power switch** for a few seconds to boot up the device. The display shows a boot-up screen for a few seconds.
- After the boot sequence is completed and the screen shows the **main user interface**, adjust **MASTER volume** to the appropriate volume



Note: During the boot process, the GE1000 will load the last preset that was active before shutdown.

Main user interface

The GE1000 comes with two types of main interfaces: the **STAGE VIEW** and the **EDIT VIEW**. You can use the **HOME** button to switch between the two views.

Stage View

This interface highlights the preset numbers and names, making it easy for players to keep track of the currently selected sound during live performances.

We have designed two different STAGE VIEW screens: the "**Detail**" mode, showing number and name of the selected preset as well as a graphic representation of the effects chain, and the "**Large**" mode, showing only the number and the name of the preset for better visibility on stage. You can select your preferred view under "Settings - Preferences". (See [Stage View](#))

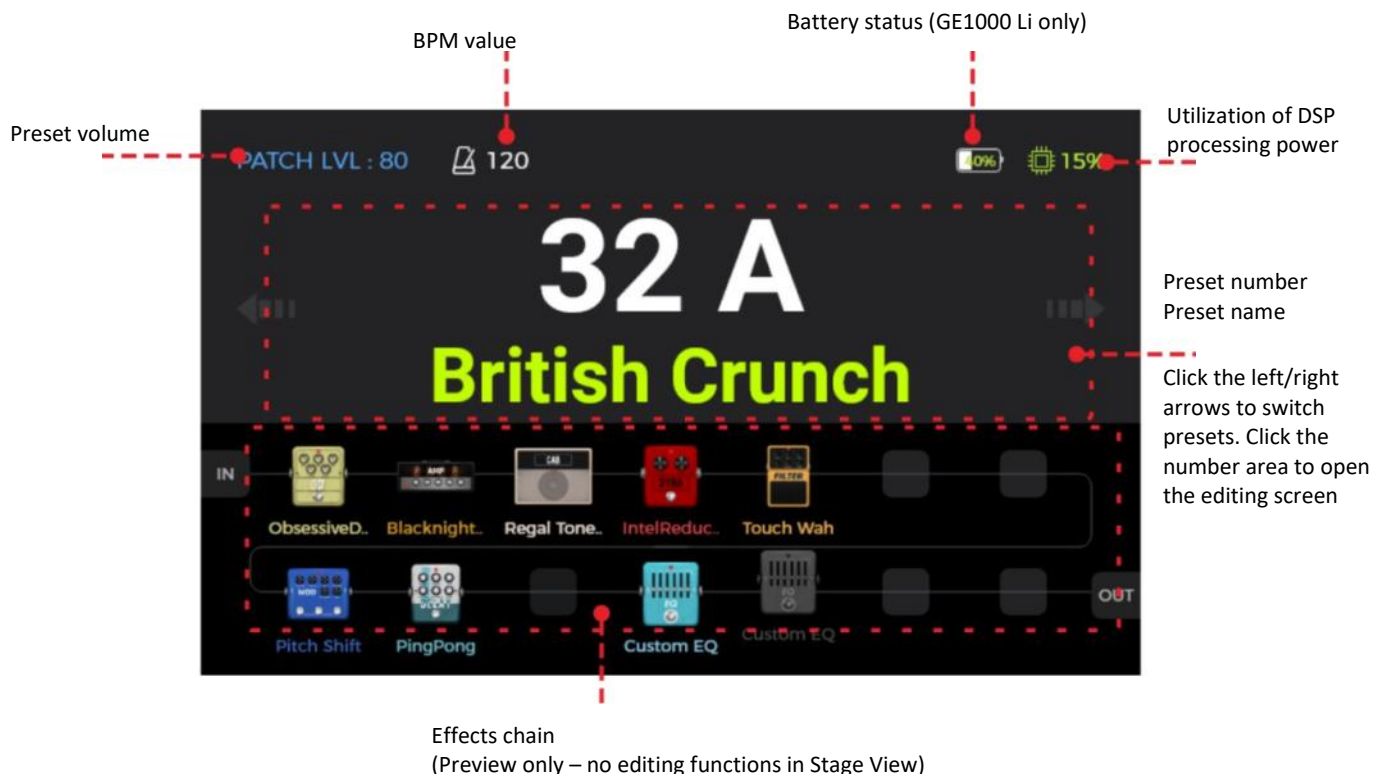

Stage View: Detail mode

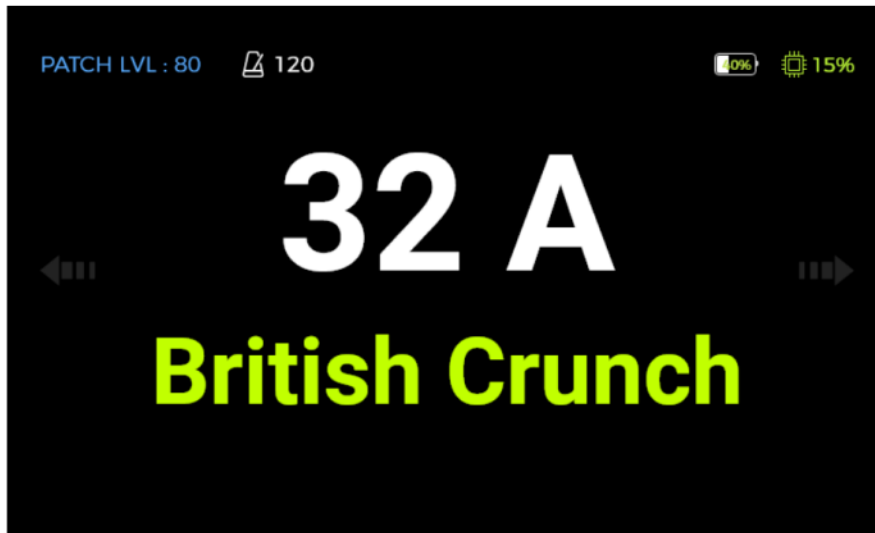

Stage View: Large mode

Click the **left/right arrows** in the screen or rotate the **SELECT knob** to switch presets.
 Click the screen or press the **SELECT knob** or the **HOME button** to enter the main editing interface (Edit View)

Edit View

Almost all control functions of the GE1000 are concentrated in the **Edit View** user interface screen. This is where you access effect parameters for editing, bring up a list of presets, save presets, adjust global inputs and outputs, open the "Groove Station" or the Tuner, or access system settings and other features.

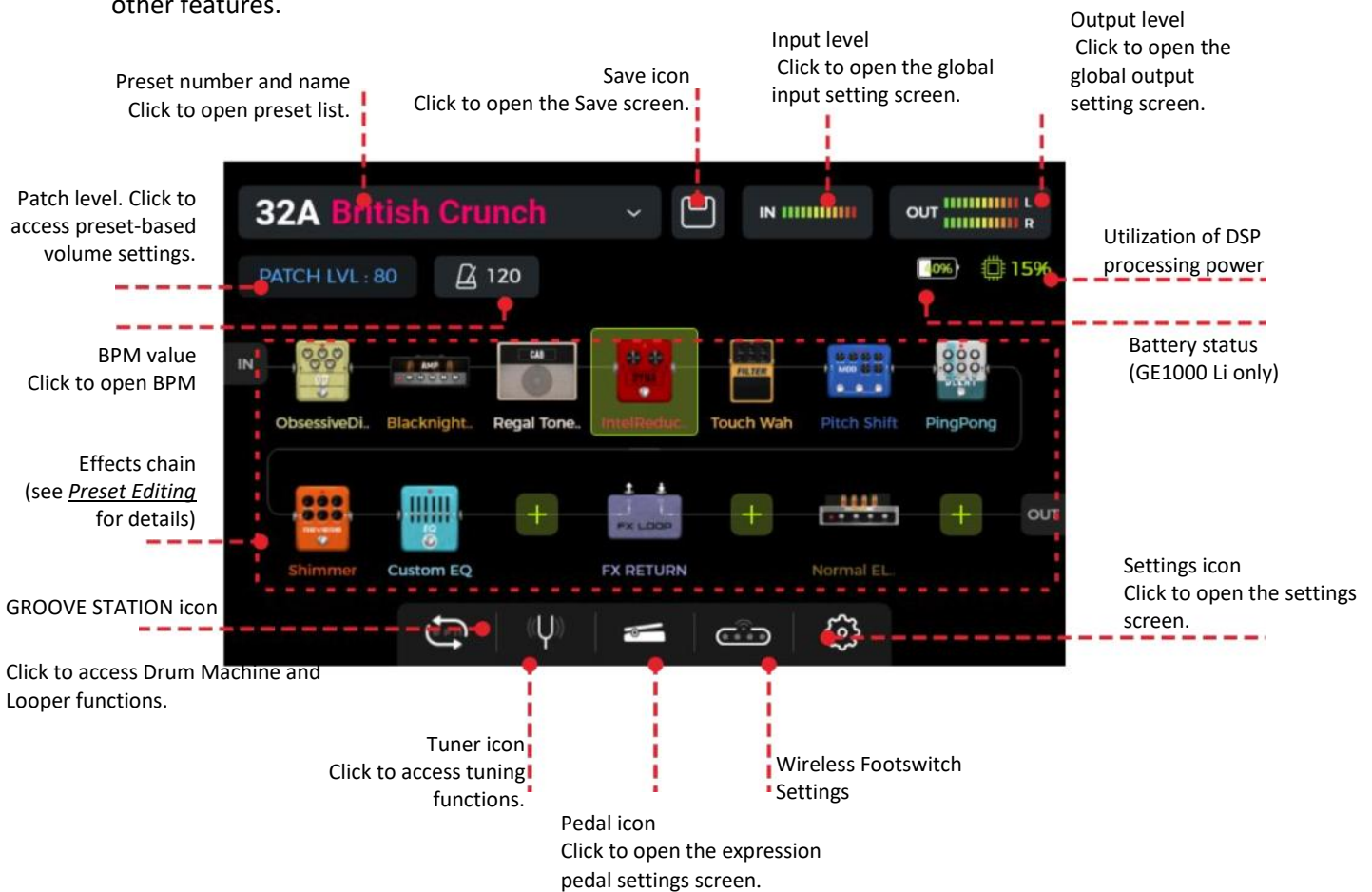

Preset selection

There are several ways to select a preset after the pedal has powered up:

1. In **Stage View**: click the left/right arrows on both sides of the screen.
2. In any of the main interfaces (**Stage or Edit view**): rotate the **SELECT** knob to select a preset.
3. Click on the **preset name area** in the upper left corner in the **Edit View** to expand the list and select a preset.
4. Directly switch between the 3 presets in the current bank using the **A/B/C footswitches** when the pedal is in regular operation mode (LED for both BANK footswitches and one of the A/B/C footswitches is lit).

The LED of the A/B/C footswitch indicates the currently selected preset.

Bank Switching

Switch banks by using the BANK ▲/▼ footswitches to select the desired bank and then press one of the A/B/C footswitches to select one of the 3 presets in this bank.

Once you press one of the BANK ▲/▼ footswitches, the screen shows the bank switching screen with the bank numbers on the left and the three presets (A/B/C) for in each bank.

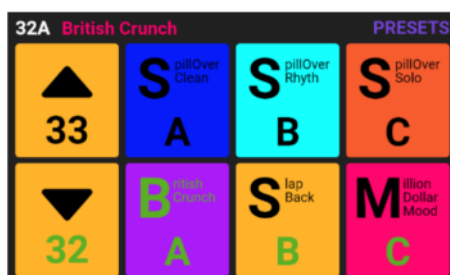

Press one of the A / B / C footswitches to activate the respective preset and switch back to the main screen. Press the BANK ▲/▼ footswitches to scroll through the banks.

Shut down

Press the **Power** button for about 3 seconds until the message "Are you sure to Shut Down?" appears on the screen. Confirm the shutdown (YES) or cancel it (NO).

Note for the GE1000 Li: If the power cable is still connected after shutdown, the screen will show a dimmed graphic to indicate the battery charging status.

OPERATION

Preset editing

It's not uncommon to browse through the factory presets and feel like they're not even close to being interesting. There may be a big difference to what you like, due to the instruments we use for testing and the platforms we use for sound optimization, or maybe you simply feel that we suck at what we do. Never mind. Follow this section and start creating your own tones.

Before you start editing, it is recommended that you open an empty preset (named 'EMPTY') to work with.

Preset composition

A preset in the GE1000 consists of the following components:

- all effect models (modules) positioned in the current effect chain,

- the effect chain sequence,
- the on/off status of each module in the chain,
- the module parameter settings of each module,
- the expression pedal parameter settings,
- the preset volume value (PATCH LEVEL),
- the BPM value (if used by effects within the preset),
- the preset name,
- the color label.

Adding effects

You can add effects to the effect chain in the following two ways:



1. **Click on an empty effect slot** in the effect chain (shown as a "+").
2. **Press one of the physical module buttons** that corresponds to an empty slot in the chain (unlit). The module buttons correspond to the 14 available effect positions in the on-screen effect chain.



The physical button for the selected position will start blinking and the screen will show a list of available effects. Select an effect module category on the left side of the screen. Then select the specific effect type from the list on the right. See [ANNEX1: EFFECT DESCRIPTIONS](#) for a list of available effects.

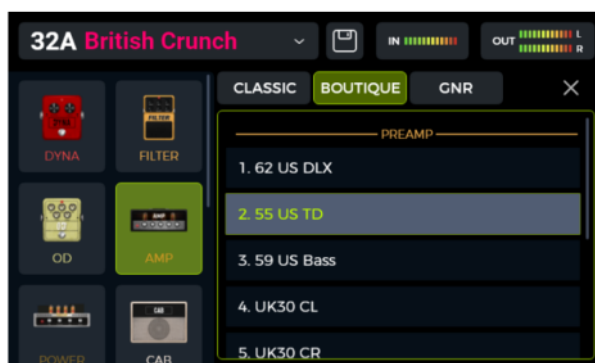

Note: The GE1000 effect chain is divided into two lines: A and B (the A/B designations are only relevant for MIDI mapping, see [CC Mapping](#)). Each line has 7 positions for effect modules, for a total of 14 effect modules. The effect chain supports the addition of several instances of the same effect module (with the exception of the FX LOOP module).

DSP resources

The number of modules in the chain and the number of times the same module that can be added is limited by the DSP (Digital Signal Processing) resources allocated to each module by the operating system. Depending on their complexity, some modules may require more DSP resources than others. The DSP load only depends on the existence of the module in the chain, not on their on/off status or their parameter settings.

Check the **DSP processing load indication** in the upper right corner of the display. It shows the balance of DSP resources required for the currently selected modules. With increasing percentage of utilized DSP resources, some modules may no longer be available for addition to the effects chain (grayed out in the list) because adding them would exceed the remaining available DSP resources.

Using the Groove Station features will also add to the DSP load.

The DSP resource indication usually takes a few seconds to update after a module was added or removed from the chain. Avoid using close to 100 % DSP resources or you may experience sound clipping due to transient overload conditions.

Activating / deactivating effects

Note: Active modules are shown as **colored icons** in the effects chain and their button LED is brightly lit. Deactivated modules are shown as **grey icons** and their button LED is dimmed.

Option 1: Slide the effect icon on the touch screen slightly up/down to activate/deactivate the module.



Option 2: Select a module on the touch screen (highlighted by a frame) and press the **SELECT** knob to activate / deactivate the module.



Option 3: Press the **physical module button** corresponding to the desired module. The first press opens the parameter editing interface. Every subsequent press on the same button toggles the selected module on/off.



For more options to activate/deactivate effect modules while playing, see [Toe switch mapping](#) for the EXP1 pedal, [CTRL Mode](#) or [MIDI](#).

Changing effect positions

The sequence of modules the signal has to pass through in the effect chain has an effect on the resulting sound. Changing the relative order of the modules in the effect chain is therefore not only a question of operational convenience, but also important for achieving the desired sound.

Option 1: On the touch screen: use your finger to **drag** the module to the desired position in the chain. Should the desired position already be occupied, the other modules in the chain will automatically shift out of the way to the next available position.



Option 2: Select a module on the touch screen (highlighted by frame) and rotate the **SELECT** knob to move the module.



Removing effects

If you need to remove an effect module from the effect chain of the current preset, **long press** the target module on the touch screen until the **delete symbol (-)** appears in the upper right corner of the module icon. Then click the delete symbol to remove the effect module from the chain.



Touch the blank area above the effect chain on the touch screen to return to the normal state (the deletion icon disappears).

Parameter editing

Double click a module icon in the effect chain on the touch screen or press the corresponding **physical module button** to open the parameter editing interface. The module button corresponding to the module will blink slowly to indicate that you are editing.

You can adjust the parameters in the following two ways:

Option 1: Touch the desired parameter dial on the touch screen, and use your finger to slide the dial to the desired value.



Option 2: Touch the desired parameter dial on the touch screen (parameter name is highlighted in green), and use the **SELECT** knob to fine-tune the desired value. You can also press the SELECT knob to return the parameter to its **default value**.

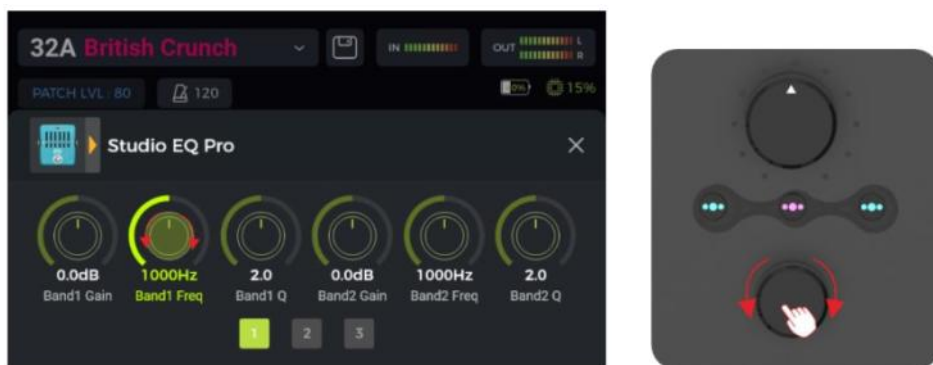

If the module has more parameters than fit on one screen page, please click the page number below the parameter dials to access the next page.



Click the "X" in the parameter editing screen to return to the main Edit View.

See [ANNEX 1: EFFECT DESCRIPTIONS](#) for parameter descriptions.

Changing the effect model/type

To change the current effect module to another model or effect type, open the parameter editing screen for the module you want to change (see above) and click the effect icon in the upper left corner. The effect selection screen is opened, from which you can select the desired effect category and the specific type.

Click the "X" in the upper right corner of the selection screen to return to the parameter editing screen. Click the "X" in the parameter editing screen to return to the main Edit View.



Preset volume

Click the **PATCH LVL** field in the upper left corner of the Edit View to adjust the overall output volume of the current preset. This function is convenient for quickly adjusting the volume balance between presets. After the pop-up window for adjusting the **preset volume** appears, change the PATCH LEVEL volume value by sliding the fader up and down with your finger or by rotating the SELECT knob.



Click on an area outside the pop-up window to return to the Edit View.

Note: The preset volume only affects the output level of the current preset in comparison to other presets. Use the MASTER knob to control the output level of all presets simultaneously.

BPM tempo

Some effects of the GE1000 such as DELAY and MOD modules have a time / rate parameter value that can be controlled by adjusting the BPM (Beats per Minute) value. See section [Parameter editing](#) for details on how to apply the BPM tempo to an effect parameter.

Click the **metronome icon** in the Edit View to open the BPM screen.

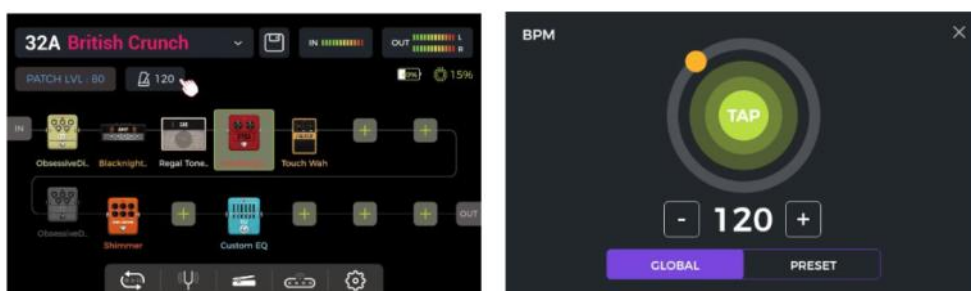

The **GLOBAL** and **PRESET** options in this screen can be used to determine which presets the selected BPM tempo is applied to. **Please make this choice before you change the tempo!**

If **PRESET** is selected, the tempo change is only effective for the **current preset**, and other presets can have different tempos. **You need to save your preset** before switching to another preset.

If **GLOBAL** is selected, the tempo value change is effective for **all presets**, and all other presets will be set to the currently displayed value. **Global BPM changes do not have to be saved and will overwrite all individual BMP settings for other presets.**

You can set the tempo value in several different ways:

Option 1: Adjust the tempo value by sliding the orange dot around the circle.

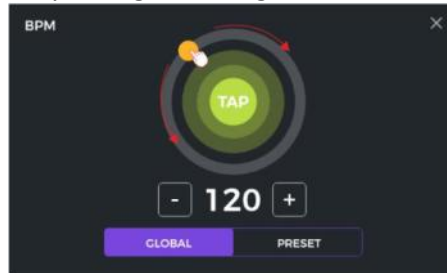

Option 2: Adjust the tempo value by tapping the "TAP" dot on the touch screen several times.



Option 3: Fine-tune with 1 BPM resolution by clicking the '-/+ ' fields.

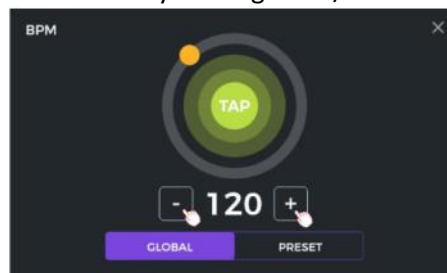

Option 4: Fine-tune with 1 BPM resolution by rotating the SELECT knob while this screen is open.

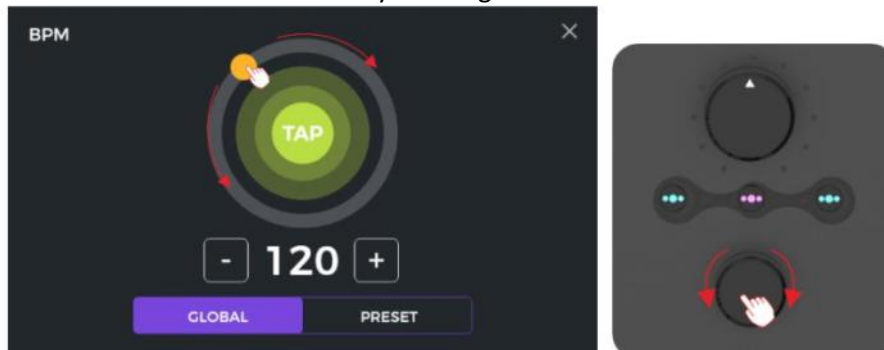

You can use any of these four methods, or a combination of them, to quickly adjust the desired BPM tempo.

Note: The speed range of GE1000 is 40 - 260 BPM.

Tap the "X" in the upper right corner to return to the main Edit View.

Saving presets

Note: If you switch presets (see *Preset Selection*) without saving your settings first, **all changes will be lost** and the preset will return to the previously saved settings the next time you select it.

After adjusting all necessary settings, press the physical **SAVE** button on the panel or click the **Save icon** on the touch screen in Edit View to save your settings.



This will open the Save screen:

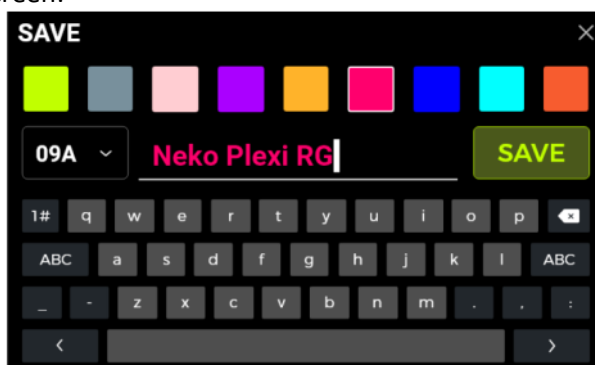

Select a **color** from the top row. The selected color will be applied as follows:

- the color of the **preset name** in the main interface (Edit View and Stage View),
- the color of the **label** and the preset name in the drop-down preset list of the Edit View,
- the color of the **LED ring** around the A/B/C footswitches in Stage and Edit mode,
- the color of the large **preset block** in the selection screen after one of the **BANK** footswitches was pressed.

You can set several presets to the same color or to individual colors to quickly find them during stage performances without having to think about this too much while you are playing.

Enter a **preset name** using the on-screen keyboard.

Click the **preset number** to the left of the preset name to open a drop-down menu to select a desired preset slot. The currently used slot is used by default.

Note: Any already existing settings in a selected preset slot will be overridden by the current settings.

Click **SAVE** or press the **SAVE button** again to confirm the saving process. You will be prompted for another "YES/NO" confirmation on the touch screen.

Cancel: Click the "X" in the upper right corner or press the HOME or SETTING buttons to exit the saving process without saving.

AI Equalizer

The AI EQ MASTER is a self-learning graphic equalizer. The built-in self-learning algorithm can automatically adjust the master tone frequency response curve based on a selected sound type and style of music. This is helpful to quickly achieve an almost ideal baseline for tone adjustments.

To use the feature:

- Add an Equalizer module at the desired position in the effect chain.
- Select "**AI EQ Master**" in the EQ category.
- Use the drop-down menus to select the **Type** of sound (Clean, Overdrive, Distortion ...) and the **Genre** of music you want to use (Rock, Pop, Blues ...).
- Click the **red button** to start the learning process and play a phrase until the progress bar below the buttons reaches the end and a frequency response curve is generated.

Note: If no curve is generated after the progress bar has reached the end, the AI was unable to extract enough information from your playing to generate the curve. Start the learning progress again and play a greater variety of chords in different positions on the neck to generate a larger sample size for the AI.

- Use the 5-band equalization controls below to **fine-tune** the results to your preference.



- Click on the areas below the EQ controls to cycle through **Gain, Frequency and Q** adjustments.
- Compare the difference in tone before and after processing by clicking the **ON/OFF** button.
- If you are not satisfied, you can click the **trashcan** icon to delete and start a new learning process.

Note: The learning results are **stored with the preset** (don't forget to save before switching presets) and can be used in this preset only. You have to go through the learning process for each preset you want to use the AI EQ Master with.

CTRL Mode

The **CTRL** (control) mode is a footswitch mode based on the currently selected preset.

In CTRL mode, the A/B/C footswitches can be used to control modules in the effect chain of the current preset the same way you would control stompboxes on a physical pedal board by using the **ON/OFF footswitches of individual pedals**. Alternatively, one of the footswitches can be configured for **Tap Tempo** input to set the tempo for Delay / Reverb effects. In **Stombox** mode, one press of a footswitch can toggle one (Single mode) or several (Multiple mode) modules in the effect chain.

In addition to this, you can use the **Sub Patch** mode to program up to three complex switching scenarios like activating/deactivating several modules at the same time and additionally switch one or several parameters to a different value. These three scenarios are called **Sub patches** and can be activated using the A/B/C footswitches in CTRL mode.

The configuration of the footswitches only affects the currently selected preset. Each preset can have different CTRL mode footswitch configurations.

Activating the CTRL mode

In Stage View or Edit View, one of the **A, B or C** footswitches will have its LED ring illuminated to indicate the currently active preset. Step on this footswitch to open the CTRL mode.

The touch screen now displays two fields for each of the three selectable footswitches (A/B/C).

Use the ▼ switch to switch between STOMPBOX and SUB PATCH mode.

In **Stompbox** mode, the lower row of A/B/C fields is highlighted and the word "**STOMPBOX**" is shown in the upper right corner.

In **Sub Patch** mode, the upper row of A/B/C fields is highlighted and the word "**SUBPATCH**" is shown in the upper right corner.

You can leave the CTRL mode and return to Stage View or Edit View by pressing the BANK ▲ footswitch or any of the HOME, SAVE, or SETTINGS buttons.

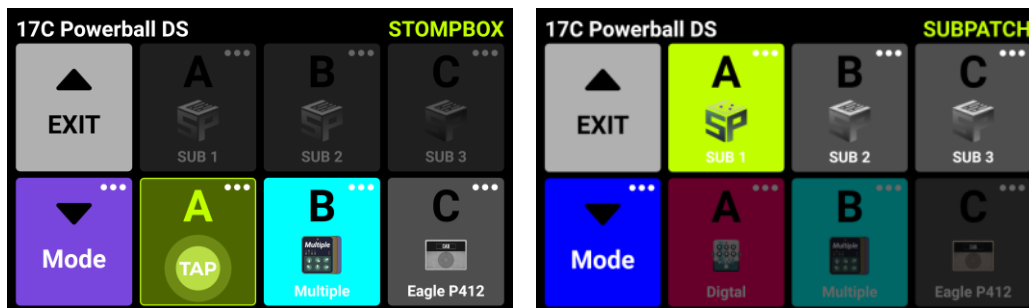

Footswitch functions correspond to the indication in the respective fields. I.e. in Stompbox mode, footswitch A will carry out the function indicated in the A field in the lower row and in Sub Patch mode, footswitch A will carry out the function indicated in the A field in the upper row. The field in the screen and the LED ring around the footswitch indicate which function is currently activated.

A field will show EMPTY when no function is assigned yet.

Summary:

- Use the A/B/C footswitches to execute the assigned functions as indicated in the fields on the screen.
- Use the ▲ footswitch to exit the CTRL mode (this switch cannot be assigned to a different function).
- Use the ▼ switch to switch between the Stompbox mode and Sub Patch mode.

Assigning CTRL functions

Before configuring CTRL functions, you need to select the sub-mode you want to configure: Sub Patch mode or Stompbox mode. Use the MODE ▼ switch to toggle between the modes.

After configuration is complete, the A/B/C footswitches can be used to perform the selected functions **for as long as the CTRL mode is active**. (See [F4 WIRELESS FOOTSWITCH](#) for additional options.)

Note: CTRL footswitch assignments must be manually saved into a preset. If you switch presets before you save the current preset, your CTRL assignments for the current preset will be lost. (See [Save presets](#))

Stompbox mode

Click on the "..." symbol in the upper right corner of each footswitch field in the lower row to assign either **tap tempo** (TAP) or **effect modules** (STOMPBOX) to each footswitch.

Use "**Clear**" to remove an assigned function or "**Rename**" to assign an easily recognizable name to the field (only if STOMPBOX is assigned). This name will only be used in the footswitch field in CTRL mode, not in the Edit View.



If set to the **TAP** function, this footswitch can be tapped several times to input the desired BPM tempo for effect parameters that are capable of interpreting this value (e.g. Delay effects). The LED ring of this footswitch will blink to indicate the selected tempo.

Single mode

If set to **STOMPBOX (SINGLE)**, a sub-menu showing all effect modules in the current effect chain will be displayed. Select one by clicking on it. This module will then be directly turned ON/OFF by stepping on the respective footswitch in CTRL Mode. Confirm your selection by clicking **SAVE**.

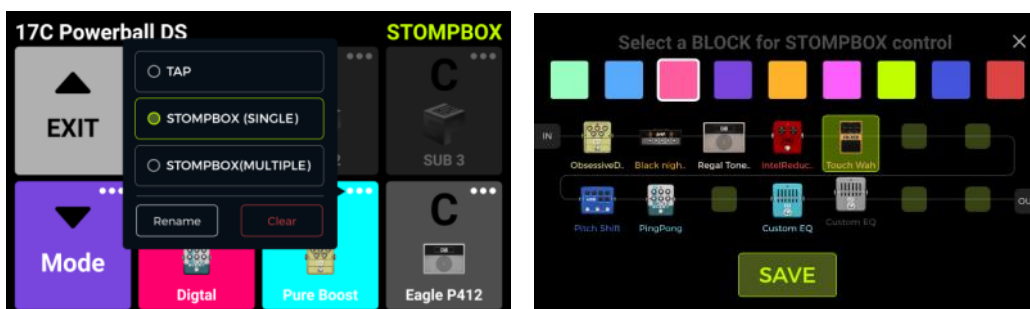

Sub menu in Single mode

Multiple mode

If set to **STOMPBOX (MULTIPLE)**, a sub-menu showing all effect modules in the current effect chain will be displayed. You can select several of them by clicking on them. These modules will then be directly and simultaneously toggled ON/OFF by stepping on the respective footswitch in CTRL Mode. Confirm your selection by clicking **SAVE**.

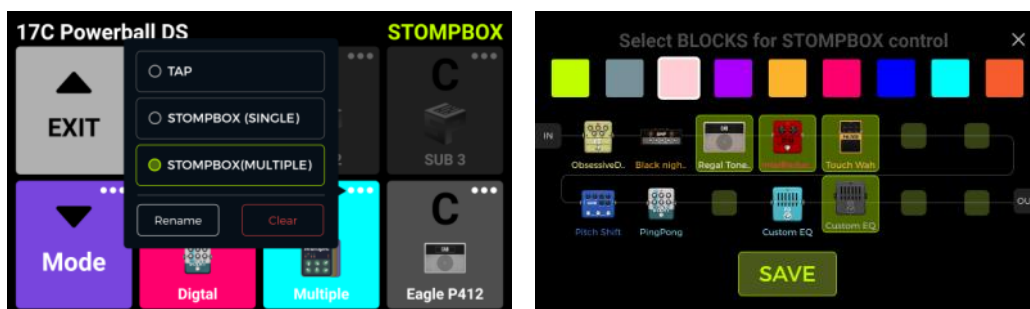

Sub menu in Multiple mode

In the top row of each selection screen you can select a color for the respective footswitch field in the CTRL screen to make finding the correct effect easier on stage (the same color will be used for the LED ring around the footswitch).

The field for a footswitch with multiple modules assigned will show a "Multiple" label and an icon indicating multiple effect modules.

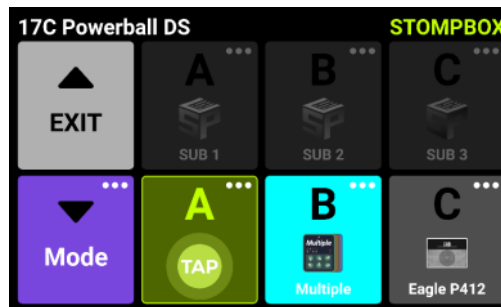

CTRL screen, showing properly configured footswitches in STOMPBOX mode

Sub Patch mode

The Sub Patch function allows you to change the on/off status of a module in the effect chain and at the same time also change the status of parameters with the same footswitch action. This way you can realize pretty dramatic changes in sound. You can change the type of the amplifier head model, toggle a delay effect and modify the distortion, etc. - all without changing the preset. You can have three different Sub Patches (Sub 1 - Sub 3) for each preset. They can be individually selected using the A/B/C footswitches.

Application scenario:

When using the Multiple mode described above, you may have wondered if you could change both the ON/OFF state of some modules and at the same time change parameter values with a single step of your foot. You can use the Sub Patch mode to accomplish complex switching scenarios like this. You can load all the effect modules usually required by two completely different presets into one preset. In the **parameter settings view**, you can allocate parameter mappings to a corresponding group (Sub Patch) by **long-pressing the parameter icon**. In **CTRL mode view**, you can adjust the combination of modules for the group. The following section describes the setup of a Sub Patch in detail.

1. Mapping a parameter to a Sub Patch

- Open the parameter editing view and long-press the parameter you want to control with Sub Patch mode.
- Select Sub Patches in the pop-up menu. This opens a sub-menu for setting the parameter values controlled by Sub Patches 1, 2 or 3 (Sub1 ... Sub3).
- Adjust the parameters and click **DONE** to confirm.
- You can click the Delete icon (-) on the right side of the parameter to cancel the parameter mapping.



A parameter mapped to a Sub Patch will have the parameter name displayed between two asterisks to indicate the Sub Patch mapping:

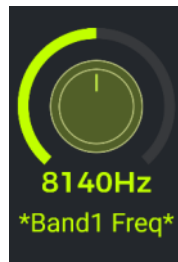

2. Configuring the effect module switching status for a Sub Patch

- Step on the footswitch for the currently active preset to open the CTRL mode view.
- Step on the ▼ footswitch, to switch the CTRL functions between Stompbox mode (Single or Multiple) and Sub Patch mode.
- In Sub Patch mode, the upper row of A/B/C fields in the screen is highlighted. Click the ... icon in the upper right corner of the A/B/C fields and select **SubPatch Setting** to view and adjust the settings for the respective Sub Patch.
- A sub-menu showing the effect chain will be opened. Move the effect models to the desired positions and set their on/off status for the respective Sub Patch.
- You can also use the color blocks in the upper part of the screen to select a color for the Sub Patch field in the screen and for the LED ring around the footswitch, when this Sub Patch is active.
- Click **DONE** to complete the settings.

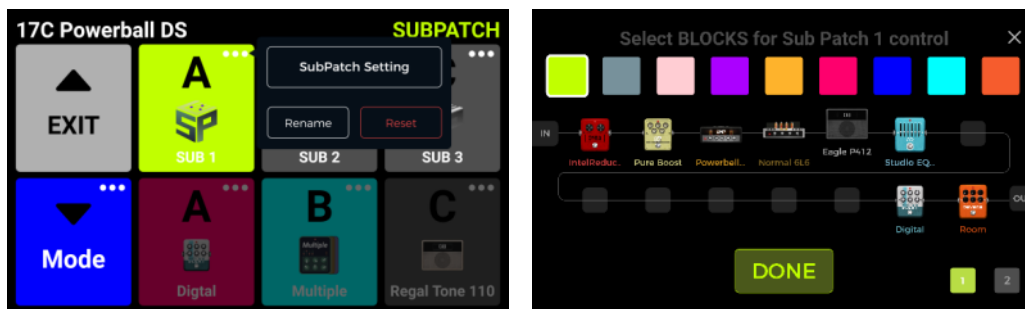

3. Modifying / deleting parameter settings in a Sub Patch

1st method:

- Find the corresponding parameter in the parameter editing view.
- Long-press the parameter icon.
- Select **Sub Patches** in the pop-up box.
- Set different parameter values for this parameter for the three Sub Patches (Sub1 ... Sub3) or click the delete icon (-) on the right side of the parameter value to delete the mapping of this parameter for this Sub Patch.



2nd method:

- In CTRL mode view, find the Sub Patch using the parameter you want to modify and click the ... icon in the upper right corner of the Sub Patch.
- In the lower right corner of the sub-menu, select the second page to view and modify the parameters mapped to this Sub Patch.
- Click the delete icon (-) on the right side of a parameter to cancel the mapping of this parameter

to this Sub Patch.

- Click **DONE** to complete the setting changes

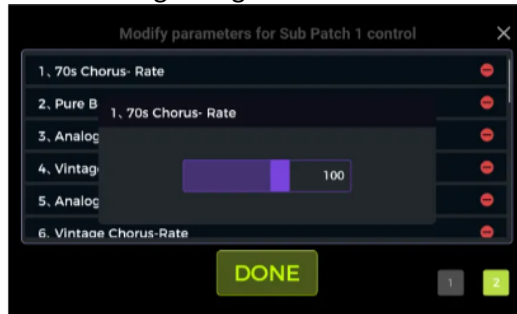

Note: You need to **save the preset** to make sure your setting changes are stored. They will otherwise get lost as soon as you change presets.

3rd method:

A parameter that has been mapped to any Sub Patch will have its name marked with two asterisks. Once you have switched to the Sub Patch to which this parameter has been mapped, you can adjust the parameter directly in the parameter editing area.



4. CTRL priority setting

The Preferences section in the Global Settings view has a Priority Mode setting, which sets the function mode that is active when you access CTRL mode for the first time in a session: Sub Patch or Stompbox mode. The priority can also be set by clicking the ... icon in the upper right corner of ▼ Mode field in CTRL mode view.

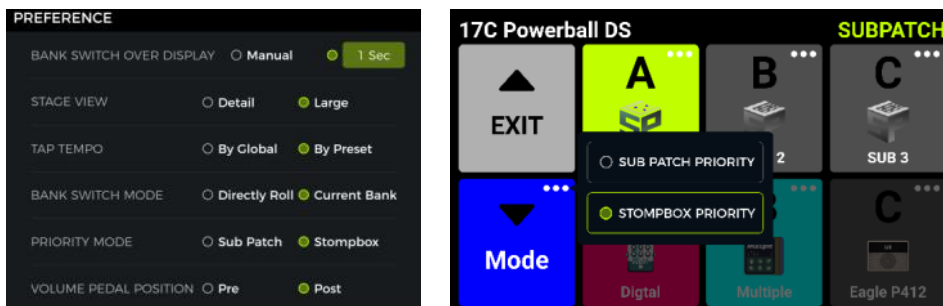

5. Renaming and clearing a Sub Patch:

By default, the three available Sub Patches are labeled SUB1, SUB2 and SUB3 in their respective fields in CTRL view mode.

Once you have configured a Sub Patch, you can click the ... icon in a Sub Patch field and select **Rename** to change the name of the Sub Patch according to your needs. Use the pop-up keyboard, and click **DONE** to confirm the new name.

Next to the Rename function you will find a **Clear** button. Use this to clear all mappings to this Sub Patch.

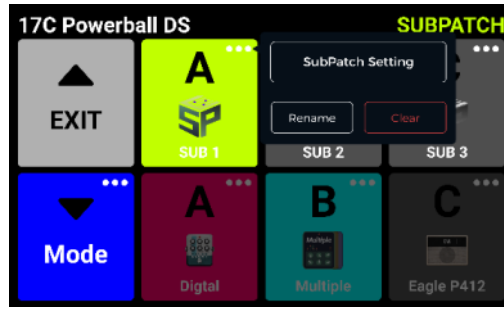

Expression Pedal

The GE1000 is equipped with an on-board rocker pedal that can be used as volume pedal (default) or as an expression pedal to control multiple modules and parameters.

You need to calibrate the GE1000's pedal before you use it for the first time. The **calibration is global** and does not have to be repeated for each Preset.

All other settings such as the **parameter assignments, the use as volume/expression pedal or the toe switch mappings** are different for each preset and **must be saved with the preset**.

Pedal calibration

Click the **pedal icon** at the bottom of the Edit View to open the expression pedal settings screen.



Click **CALIBRATE** on the left side and follow the instructions on screen: Flip the pedal all the way open and click **NEXT**.

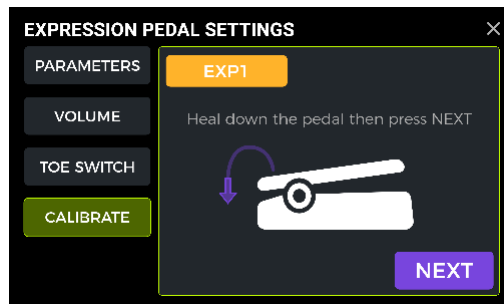

Close the pedal completely and click **NEXT**.

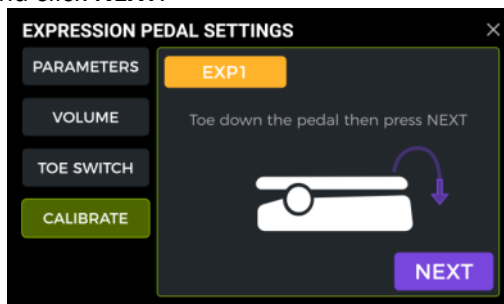

Press the pedal down at the front (toe switch) and click **DONE** to complete the calibration. A successful calibration is indicated by a **checkmark** in a green circle.

Note: The amount of force used to press the pedal down in this step determines the force threshold for the expression pedal toe switch function (see section below). It is recommended that you use your foot and apply the same pressure you would use when playing on stage.

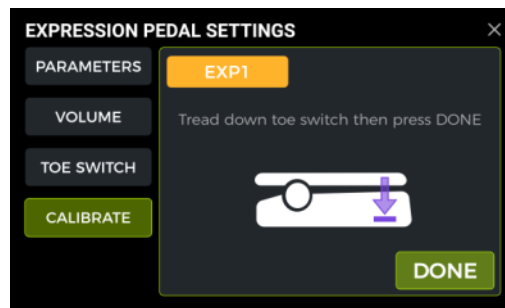

Repeat the steps, if the calibration is not successful. It should be noted that significantly more force should be used for the "TOE SWITCH" step than for the "TOE DOWN" step. A calibration error will be shown if the difference between the two is too close (i.e. the pressure during the TOE SWITCH step was too light).

Use as Master Volume / Expression Pedal

The ON/OFF status of the Logo LED on the left side of the expression pedal is controlled by using the **toe switch** of the on-board EXP1 pedal (firmly pressing down on the front).

When the GE1000 **Logo light** is **off**, the pedal will operate as a **master volume control**.

When the GE1000 **Logo light** is **on**, the pedal will operate as **expression control**.

This state will be saved with each individual preset, meaning that all presets with the logo off use the pedal as volume control and all presets with the logo on use the pedal for expression control.

Expression parameter mapping

The expression pedal can be mapped to control several effect parameters of the same or different effect modules simultaneously. All mappings affect only the current preset and must be stored with the preset. **Save your preset after mapping parameters** before you switch presets.

- Double click the effect module you want to control with the expression pedal to enter the parameter editing screen.
- Long press the desired parameter until a context menu opens.
- Select "EXP Settings" in the pop-up menu.
- Set the desired parameter values (in percent) for the closed and open positions of the pedal (e.g. "100" and "0" for normal operation or "0" and "100" for reverse operation, or any value in between).
- Click "DONE" to complete the mapping.

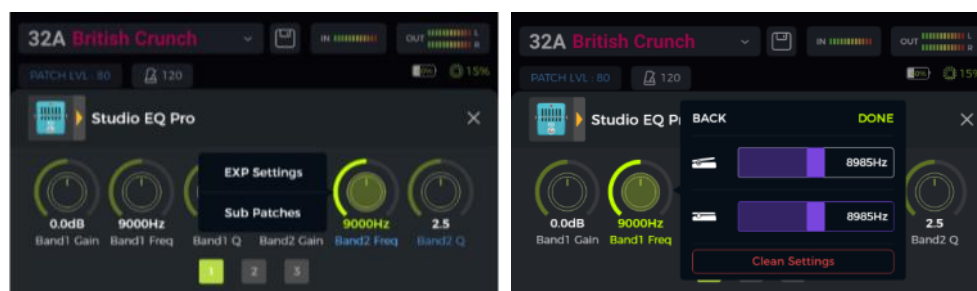

The parameters mapped to the expression pedal will have their name **highlighted in blue** to distinguish them from regular parameters. You can still adjust them manually, but as soon as you use the expression pedal, the manual setting will be overwritten by the expression pedal input.

All mapped parameters can be modified individually in the EXPRESSION PEDAL SETTINGS – PARAMETERS screen:

- Click the pedal icon at the bottom of the Edit View to open the expression pedal settings screen.
- Click **PARAMETERS** on the left side. All pedal mappings for the current preset will be listed.
- Click the parameter you want to modify, and adjust the values by sliding the bars or by rotating the SELECT knob.



Remove expression mappings

Option 1: Find the mapped parameter (name highlighted in blue) in the parameter editing interface. Long press the desired parameter. Select "EXP Settings" in the pop-up menu then click "Clean Settings" in the EXP Settings menu.



Option 2: Click the pedal icon at the bottom of the Edit View, to enter the EXPRESSION PEDAL SETTINGS screen. Click PARAMETERs on the left side.

In the list on the right: click the delete symbol (-) behind the parameter you want to remove.

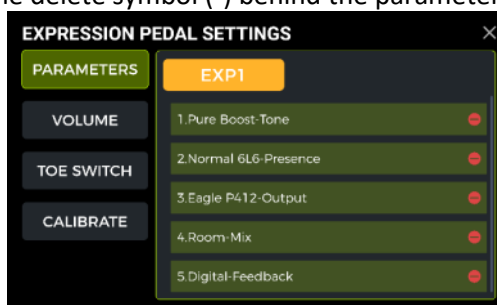

Volume Pedal Settings

Select **VOLUME** on the left side of the EXP pedal settings view to set **maximum** and **minimum** volume for the EXP pedal when it is used in volume mode.

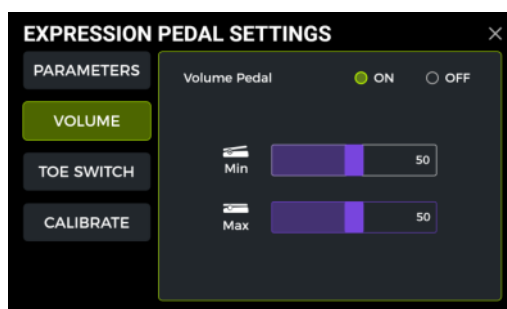

If you switch the volume pedal **OFF** in this view, pressing the toe switch will no longer switch the Exp pedal to volume mode. This way, the toe switch can be used to switch other functions (see below).

Toe switch mapping

In addition to switching the pedal function between volume and expression control, the toe switch on the front end of the pedal can also be mapped to switch modules within the preset's effect chain ON/OFF.

Example of an application scenario:

The expression pedal parameter is mapped to the "WAH Position" and the toe switch is mapped to activate/deactivate the WAH module. This simulates the functions of an actual WAH pedal.

The toe switch function can be mapped to an effect module as follows:

- Open the EXPRESSION PEDAL SETTINGS screen.
- Click "TOE SWITCH" on the left side.
- Click the **+** icon.
- Select the desired module from the effect chain.
- Click DONE.

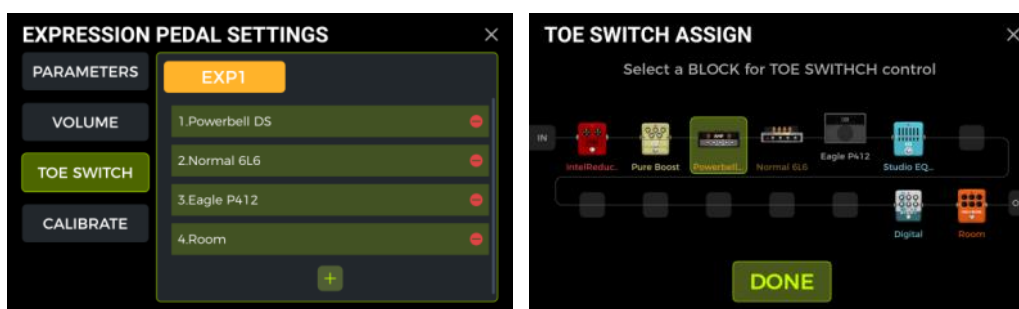

You can use the same method to add more effect modules to be simultaneously switched by the toe switch. If you want to remove a toe switch mapping, simply click the delete icon (-) next to the corresponding module in the list.

USING EFFECT LOOPS

The GE1000 is equipped with jacks for a **single-port stereo effect loop**. This means that the SEND and RETURN jacks of the FX LOOP not only support the connection of mono devices, but can also be used to connect to external stereo devices using Y-format audio cable adapters.



(Single port stereo FX LOOP)



(TRS to dual TS adapter cable, Y-format cable)

The following section explains several conventional usage scenarios for effect loops:

Connecting a single effect pedal

Connection method:

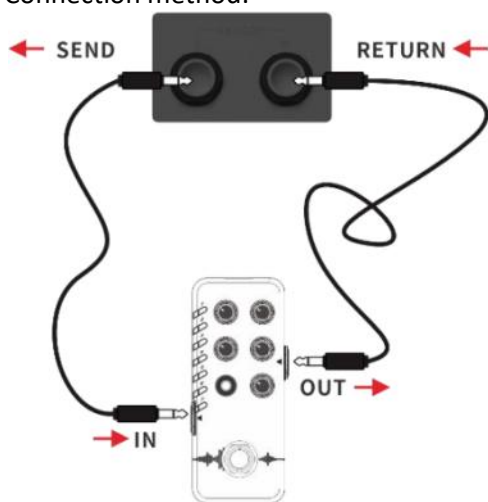

(Connection to mono effect)

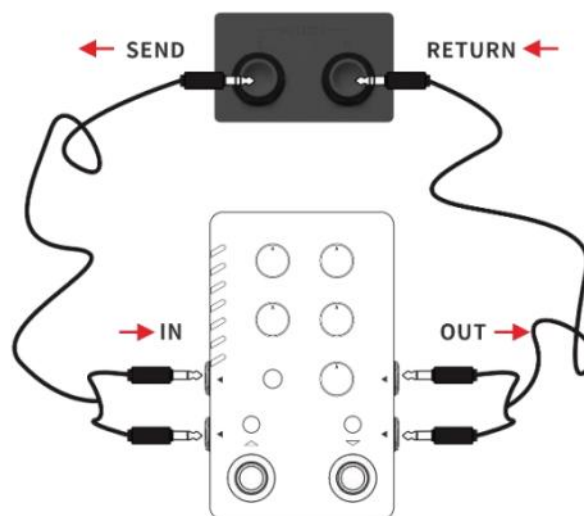

(Connection to stereo effect)

Note: After adding the FX LOOP module in the signal chain, you need to set the mode (mono/stereo) of "Send" and "Return" in the module parameters according to the actual connection situation.

Setting up the FX LOOP module

After completing the physical connections, you need to add the **FX LOOP module** to the effect chain in Edit View. There are two different ways to set up the FX LOOP module depending on the position of Send and Return in the effect chain:

Send/Return on the same node

(both SEND and RETURN occupy the same position in the effect chain)



Click  in the desired position of the effect chain, and add the effect module "FX LOOP" with type "FX LOOP". This setting is suitable for most external effects that can be embedded in the GE1000 effect chain. The actual signal flow is shown in the figure below:

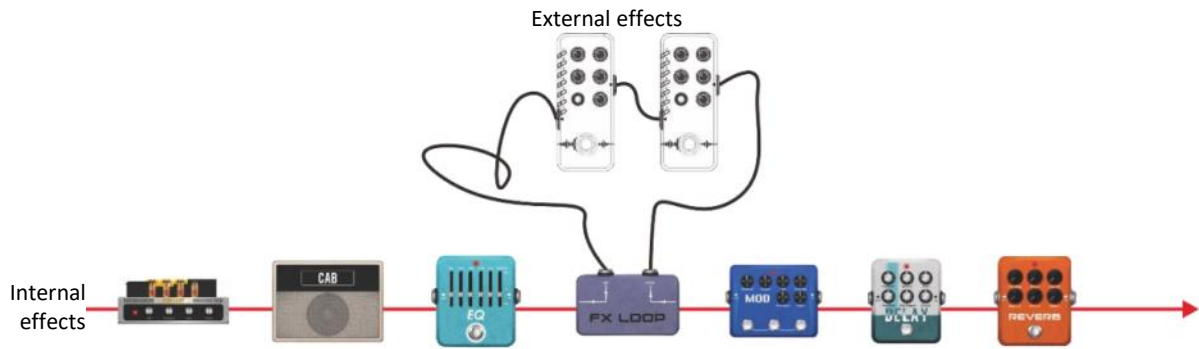

Send/Return on different nodes

(SEND and RETURN occupy different positions in the effects chain)

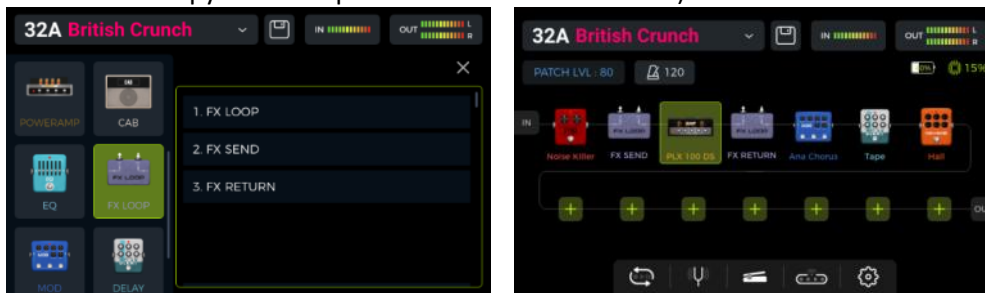

Add one effect module "FX LOOP" into the effect chain with type "FX SEND" and another one with type "FX RETURN". This setting is suitable for scenarios with the external effects in parallel with some of the internal effects or for A/B switching. The actual signal flow is shown in the figure below:

Effect loop set to **parallel connection** (FX SEND module set to Parallel Mode):

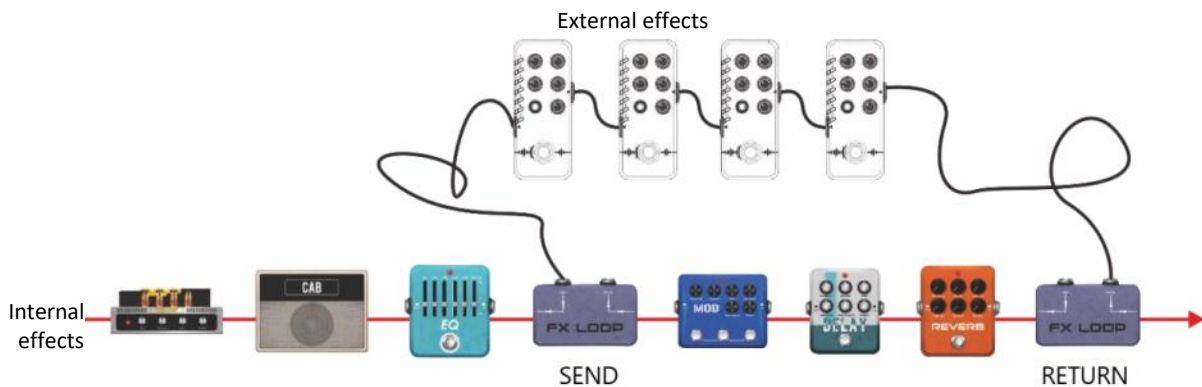

Effect loop set to **series connection** (FX SEND module set to Serial Mode):

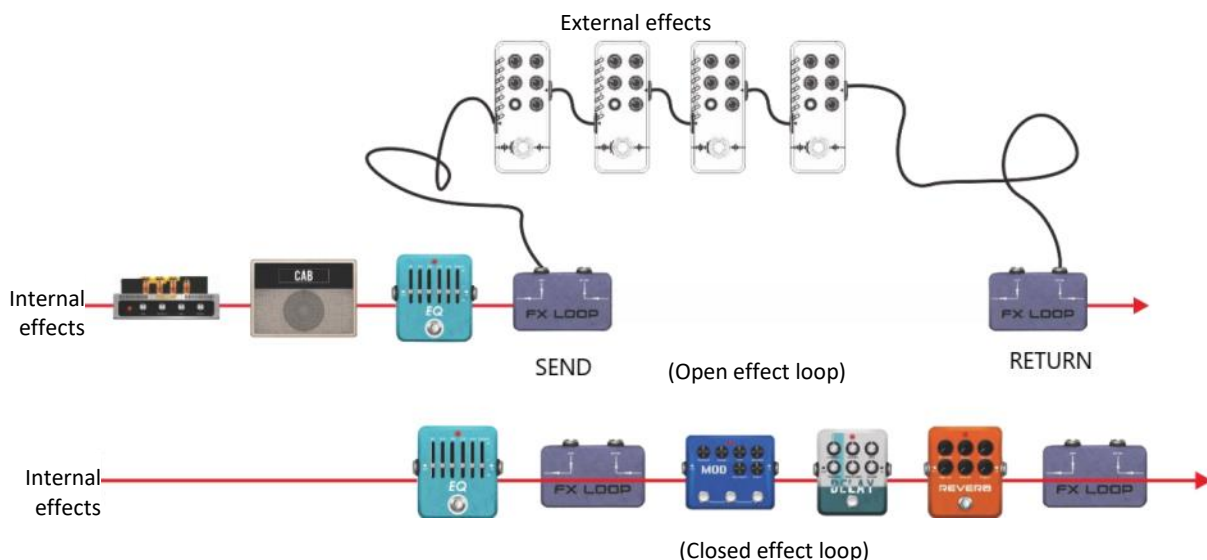

4-Wire connection method

A connection scenario in a previous chapter has already introduced the four-wire connection method (see [Four-Wire Connection](#)). This section explains the necessary module settings in the GE1000.

As the name suggests, the four-wire connection method refers to two devices with effect loop capabilities connected to each other using four audio cables. This way, the two signal links are embedded into each other, in order to achieve the specific purpose for which this method was developed.

Connection method:

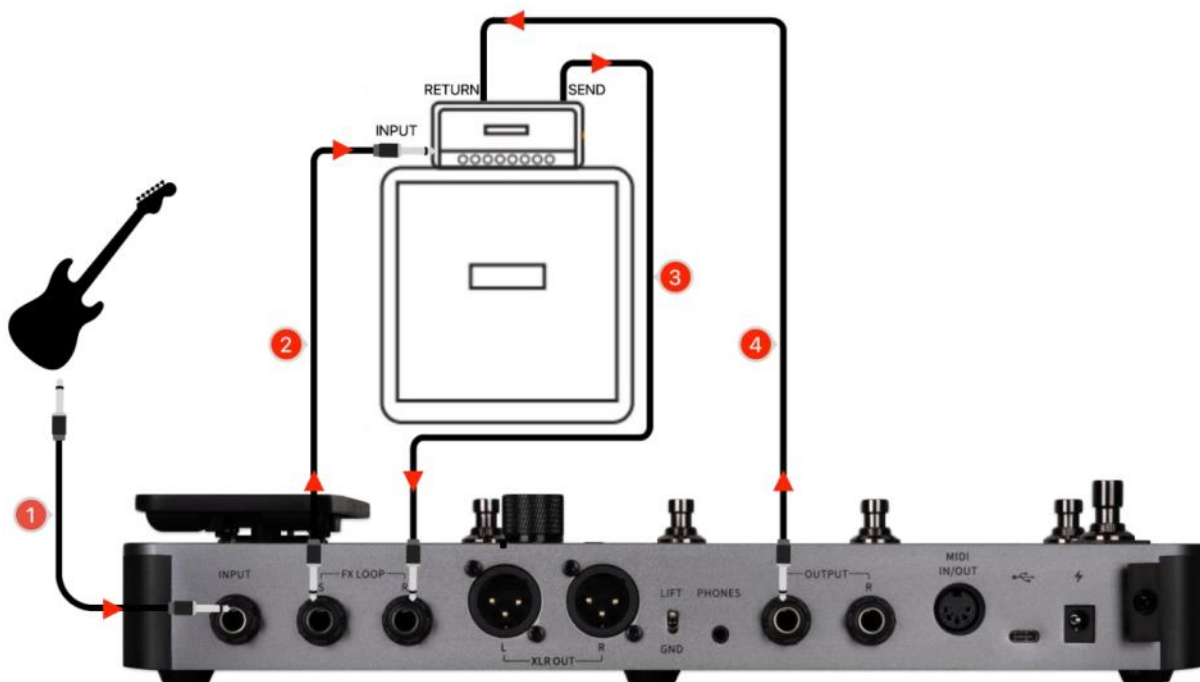

FX LOOP module settings:

Scenario 1: Splitting the GE1000 effect chain into pre-effects and post-effects.

When used with amplifiers, some effects (e.g. compression, overdrive, etc.) are better suited to be connected to the INPUT of the amp (**pre-effects**), while other effects (e.g. delay, reverb, etc.) are

better suited to be connected between the pre-amp and the power amp (i.e. in the effects loop of of the amplifier = **post-effects**).

You can achieve this scenario with the following setup in the GE1000's FX LOOP:

- Connect the GE1000 and the amplifier as shown in the connection diagram above.
- Add the FX LOOP module to the GE1000 effect chain.
- Move the **pre-effects** modules (effects suited to be plugged into the INPUT of the amp) before the FX LOOP module.
- Move the **post-effects** modules (effects suited to be inserted in the effects loop of the amp) after the FX LOOP module.
- Set the Type in the FX LOOP module to "Mono" and the Mode to "Serial".

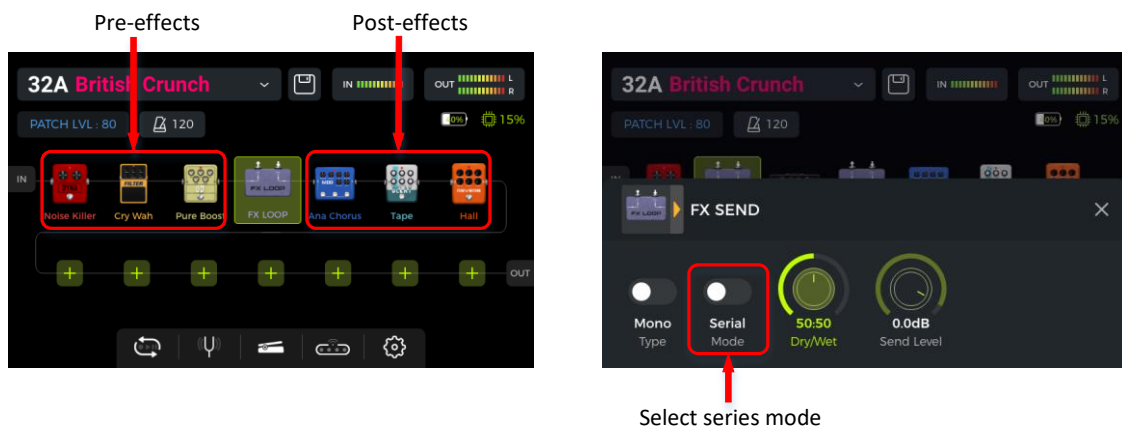

With these settings, the actual signal chain is configured as follows:

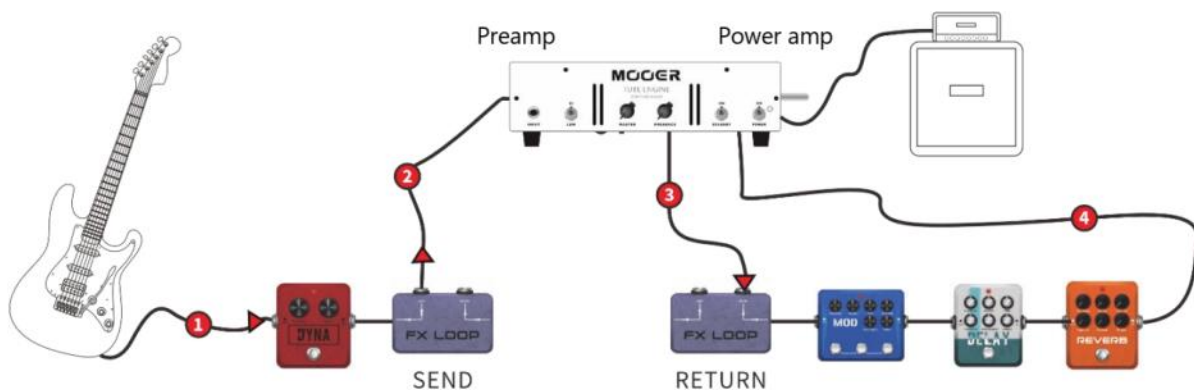

Scenario 2: A/B switching between the preamp simulation within the GE1000 and the physical preamp of the actual amplifier.

The same four-wire connection method can be used to realize **A/B switching** between internal preamp modules and a physical external preamp with the help of the FX LOOP module and a corresponding footswitch setting in CTRL mode.

- Add the FX SEND and FX RETURN modules to the GE1000 effect chain.
- Add an AMP module and select a preamp model (without cabinet).
- Move the AMP module between FX SEND and FX RETURN.
- Set the type in the FX SEND and RETURN modules to "Mono" and the Mode to "Serial".
- Set one footswitch to control the FX SEND module in **CTRL mode**.

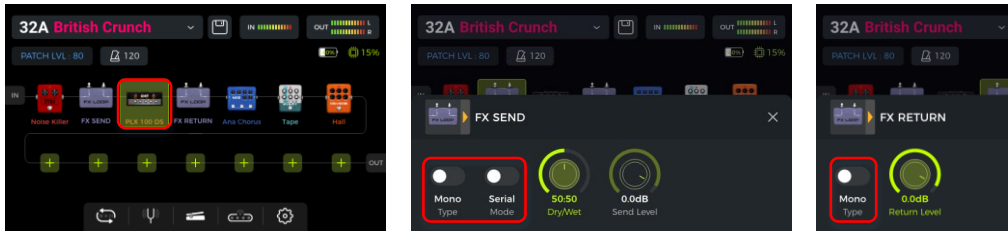

With these settings, the actual signal chain is configured as follows:

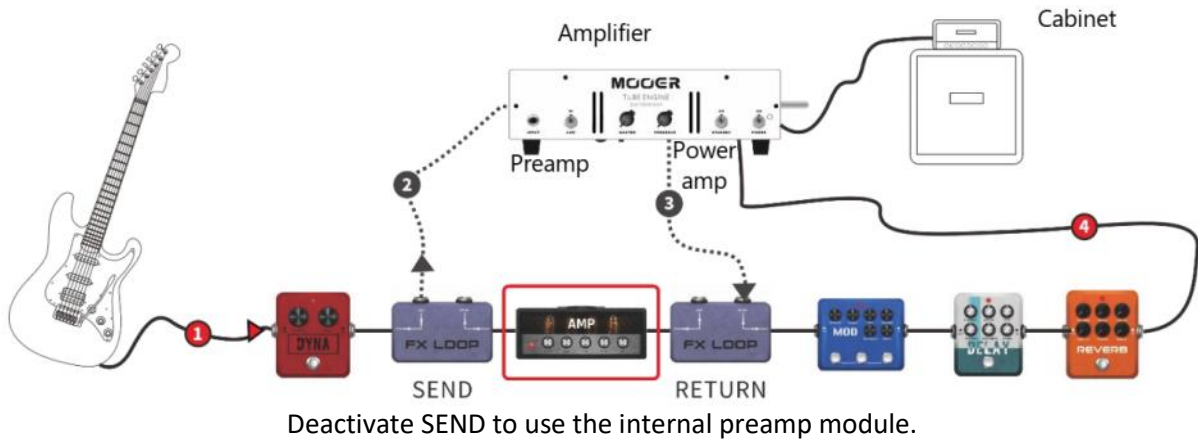
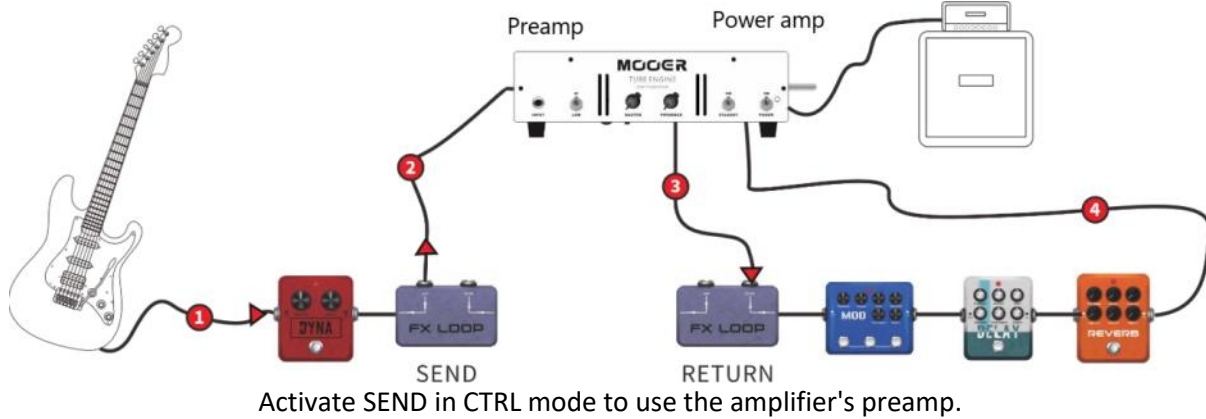

Extended input and output options

The effect loop interface is essentially an input/output interface that can define its own position, with FX SEND as the output interface and FX RETURN as the input interface. When there is no requirement for external effects or four-wire connections, the FX LOOP can be used as an extended input and output interface for several common scenarios.

Scenario 1: Auxiliary Audio Input (AUX IN)

- Add the FX RETURN module to the GE1000 effect chain.
- Move it to the appropriate position or to the very end of the effects chain if you don't want the incoming audio to pass through any internal effect modules.
- Connect an external audio source to the FX RETURN (the R jack of the FX LOOP).
- Select the type in the FX RETURN module as 'Mono' or 'Stereo' depending on the audio source.

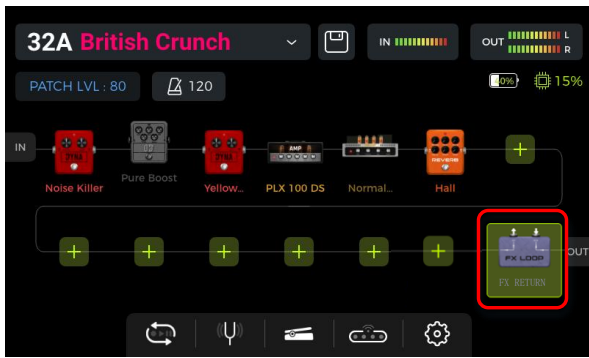

Scenario 2: Expanded output mode (e.g. different outputs with or without cab simulation)

- Add the FX SEND module to the GE1000 effect chain.
- Move it before the CAB module in the effect chain.
- Select the FX SEND module mode as "Parallel" and the wet/dry ratio as "50:50".

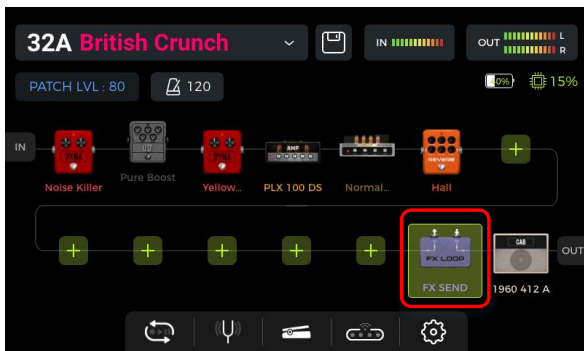

With these settings, the signal output from the FX SEND output does not have cab simulation applied, and the signal output from the other outputs includes a cab simulation.

TUNER

The integrated tuning feature can be accessed in two different ways:

- Click the **tuning fork** icon in the Edit View.
- Hold footswitches **A** and **B** down simultaneously until the Tuner screen opens.



Tuner screen

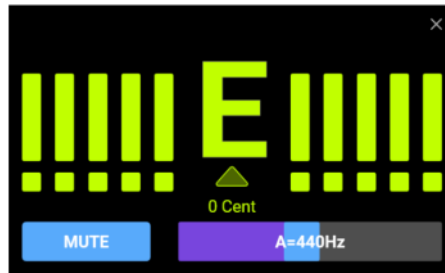

Click the field in the lower left corner or press the **SELECT** knob to switch between **BYPASS** tuning mode or **MUTE** tuning mode.

BYPASS tuning disables the internal effects and sends a **clean signal** to the outputs for as long as the tuning mode is active.

MUTE tuning mutes the outputs for as long as the tuning mode is active.

Adjust the **reference frequency** by moving the slider in the lower right corner or by rotating the **SELECT** knob. You can select a reference frequency from a range of 430 Hz - 450 Hz. The default value is A = 440 Hz.

Tuning

- Open the tuning screen.
- Pluck the open strings of your guitar. The screen will display the current note and the pitch.
- Tune your guitar until the pointer on the screen is in the center position.

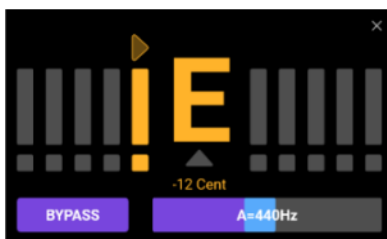

Flat

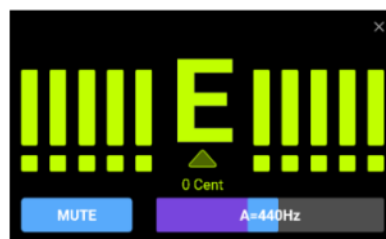

In tune

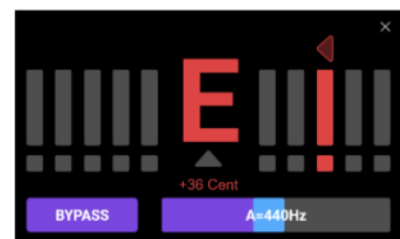

Sharp

Exit tuning mode

Use any of the following methods to exit the tuning mode:

- Click the "X" in the upper right corner.
- Press any footswitch once.
- Hold footswitches A + B down simultaneously.
- Press any of the HOME, SAVE, SETTINGS buttons.

GROOVE STATION

The Groove Station combines drum machine and phrase Looper functions. You can use these features independently or in combination. Synchronization is supported, when Drum Machine and Looper are used at the same time.

Open the Groove Station

There are two ways to open the Groove Station mode:

- Click the **Groove Station icon** at the bottom of the Edit View screen.
- Hold footswitches **B and C** down simultaneously until the Groove Station screen opens.



Groove Station screen



The five large square icons in the Groove Station screen indicate the **footswitch functions that will be performed when the footswitch is pressed the next time**. You can click the squares on the touch screen or press the corresponding footswitches to perform the functions.

The **icons at the top** indicate the REC/PLAY/STOP/REDO/UNDO status of the Looper.

The **progress bar** below indicates the recorded time as well as the current status and the position of the phrase loop during playback.

The center area shows several settings for the Drum Machine and the Looper. They will be explained in the respective sections below.

Volume sliders

The sliders for **LOOPER** and **DRUM** control the respective output volumes and can be controlled by swiping the sliders or by clicking them and then rotating the SELECT knob. The number in the slider indicates the volume in percent.

Drum Machine

Click the drop-down menus on the right side of the screen to select the **Style** (FUNK, POP, ROCK ...) for the Drum machine and also a **Rhythm Pattern** (4/4, 6/8 ...).

Footswitch B: DRUM TAP

- Press B several times to tap in the desired tempo for the drum machine. The value is indicated in the BPM bar in the center of the GROOVE STATION screen. You can also swipe the **BPM slider** in the BPM bar to set the value or click it and fine-tune with the SELECT knob. The selected tempo is indicated graphically and numerically in the **BPM bar**.

Footswitch C: DRUM ON / DRUM OFF

- Press C to start / stop the Drum Machine.

Looper

The GE1000 features a Looper with up to 8 minutes of recording time, overdubbing function and independent level control.

Footswitch ▼: REC / PLAY / DUB / UNDO / REDO

- **Tap once** for **Record**, tap again for **Play**, tap again for **Dub...**
- **Hold** for **Undo**, hold again for **Redo** (after recording more than two layers of Looper track)

Footswitch LED indication for ▼:

- **Solid Red:** Recording mode
- **Solid Blue:** Playback mode
- **Solid Purple:** Overdub mode

Footswitch A: STOP / DELETE

- **Tap once** to stop playback/recording
- **Hold** to delete the entire recording

Footswitch LED indication for A:

- **Blinking yellow:** the Looper is in Stop mode
- **Solid white:** all recordings have been deleted

Looper Auto Record

Activate **AUTO REC**, adjust the appropriate trigger threshold, and press footswitch ▼ to activate the **standby** function.

The Looper will start recording as soon as the input signal triggers the threshold. When Auto Record is not active, the recording starts immediately with pressing ▼.

Drum synchronization

Activate **DRUM SYNC** to synchronize the Looper function with the Drum Machine when both features are to be used at the same time. This way, they will both be in synch with regard to the bar structure.

- Pick the style and rhythm pattern for the Drum Machine first, and set the desired tempo.
- Activate DRUM SYNC.
- Execute "REC" for the Looper (Footswitch ▼).
A **one-bar count-in** will be played, based on the selected rhythm pattern.
- Recording will begin after the count-in, and the Drum Machine will be synchronized.

To ensure proper synchronization between the two features, at the end of the first layer of recording (in "Play" mode) and after the Looper has reached an integer number of measures, the remaining part of the phrase loop that is less than one measure will be processed in 1/2 measures: less than 1/2 measure will be trimmed, and if it exceeds 1/2 measure, playback will be delayed until it reaches a full measure.

Take a 4/4 beat as an example: When you record to the third beat of the fourth bar, playback will be executed (more than 1/2 bar), the LOOPER will record the fourth full bar and then switch to playback. The length of the loop is 4 full bars.

If playback is executed when the recording of the fourth bar ends on beat 1 (less than 1/2 bar), the LOOPER will discard the extra content of the fourth bar and immediately start playback from the beginning, and the length of the loop will be 3 full bars.

Note: In the following cases, there will be **no count-in** when synchronization is turned on:

- AUTO RECORDING is active.
- The Drum Machine is already running before the Looper recording is started.

Close the Groove Station

Use any of the following methods to exit the Groove Station Mode:

- Click the "X" in the upper right corner.
- Press the BANK ▲ footswitch.
- Press footswitches B + C simultaneously.
- Press any of the HOME, SAVE, SETTINGS buttons.

Note: If the Looper and/or the Drum Machine are playing when you close the Groove station, **they will continue playing**. You need to re-open the Groove Station in order to stop the Looper and/or the Drum Machine.

USB DIGITAL AUDIO

The GE1000 supports 24-bit, 44.1 kHz - 192 kHz, low-latency sound card functions and supports most of the host software available for Windows and Mac systems. Windows system users need to install a special ASIO driver to realize low latency recording/monitoring. Please visit the official website to download the Windows ASIO sound card drivers. Mac users do not need to install the sound card driver. The system is plug-and-play for Mac.

Parameter descriptions

You can find the parameter settings for the "USB Audio Interface" in the GLOBAL SETTINGS screen (press the SETTINGS button). Adjust the mode and parameter setting to the requirements of different usage scenarios.

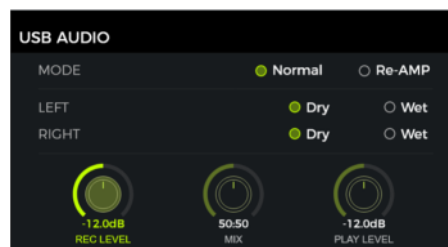

Usage Modes

Normal mode: You can use the GE1000 like an external sound card. The input will be automatically taken from the input jack of GE1000 (your guitar), and the output will be sent to the USB output port (digital signal) from the GE1000 to your computer.

Re-AMP mode: You can use the GE1000 as a sound card and at the same use the digital audio signal processing features. The USB signal input of the GE1000 (digital signal received from the computer) will automatically be used as input, and the USB output (digital audio signal) to the computer will be used as output.

The default factory setting for the GE1000 is **Normal**.

Left channel / Right channel:

When using the sound card recording function, these two switches can be used to determine whether the left and right outputs receive dry sound or processed effect sound. When "DRY" is selected, the output signal of the currently selected channel is not processed by the effect modules. When "WET" is selected, the output signal of the currently selected channel is processed by the effect modules. Selecting the left and right output signals as dry or wet can be convenient to preserve the dry signal for post-processing when recording. This way you can listen to the wet signal and record the dry signal.

The default factory setting for the GE1000 is "WET" for both the left and right channel.

Record Level: Adjust the recording level of the sound card function.

The default factory setting is 0 dB.

Mix Ratio: Adjusts the mix ratio between hard and soft monitoring.

A setting all the way to the left means that 100 % of the signal is coming from the GE1000 (hard monitoring). All the way to the right means that the 100 % of the signal comes from the computer/DAW/plugin, etc. (soft monitoring). With a center setting of 50:50, the ratio of hardware output to USB digital input is 1:1.

The default factory setting is a 50:50 mix of hard and soft monitoring.

Playback Level: Adjusts the volume level of the digital input of the sound card function, i.e. playback volume. The default factory setting is 0 dB.

Mode descriptions

Normal mode

In this mode, the GE1000 will act as an external sound card with effects and the computer software can be used for recording. The signal path of this mode is shown below:

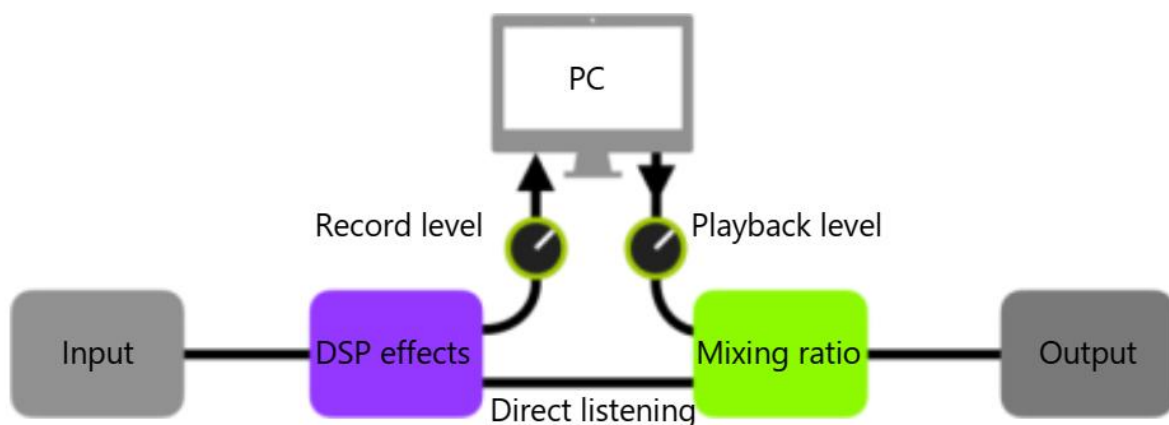

Setup:

- Set the Audio Mode to **Normal**.
- Open the recording software on the computer and configure it to use the GE1000 sound card driver. Then set the input and output ports to "Analog1/Analog2" of the GE1000.
- Adjust the **Wet** and **Dry** settings for the left and right channel depending on the recording /

monitoring requirements.

- Record a track, and pay attention to the input level indication to make sure there is no signal distortion (clipping) even with hard playing. If the input signal is too strong, adjust the **Recording level** accordingly.
- Play back the recorded track or other audio files to make sure that the return volume is appropriate (for different monitors, such as headphones or monitors), and adjust the **Playback level** accordingly.
- By playing the audio file through the GE1000, you can balance the volume ratio between the recorded audio and the live signal by adjusting the **Mix Ratio**.
- Confirm the input and output levels and start recording.

Re-Amp mode

The Re-Amp recording mode is a digital audio signal reprocessing method, which can be used to run a dry signal track from a computer through the effect modules of GE1000, and then record it as a new "wet" track. The signal path of this mode is shown below:

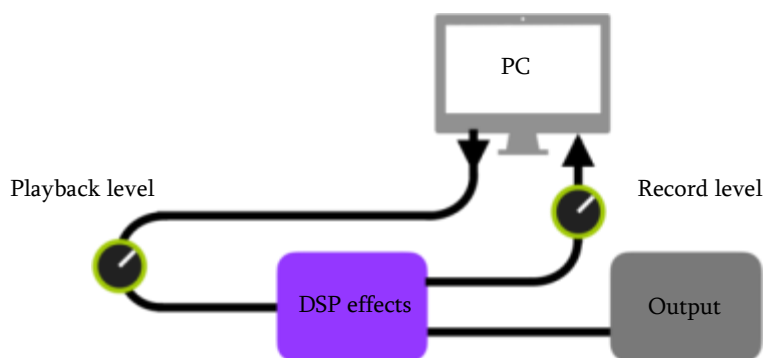

Setup:

- Open the recording software and add two tracks. One of them is a dry track that needs re-amping (pre-recorded or other audio track), the other one should be a blank track.
- Play the dry track through the GE1000 DSP effects and make sure the input level indication in the PC software shows no distortion (clipping). Adjust the level with **Record level**.
- While playing the dry track, you can also adjust the switches and parameters in the GE1000 for the desired Re-Amp effect. Listen to the output and adjust the level using the **Playback level** control.
- Select the blank track, activate the recording and play the dry track. Re-Amp is finished, when the dry track is finished.

Note:

1. After starting the recording software, you should set the GE1000 driver as input driver in the system settings or in the driver settings of the recording software. Also set the input and output ports to the input and output of the GE1000. Otherwise you could experience no input, no output, excessive lag or other abnormal conditions.
2. We recommended that you do not try to adjust settings or operate switches on the GE1000 during the Re-Amp recording process, unless this is required for special effects. This may result in undesired results.
3. Should you encounter too much lag, open the sound card driver control panel and adjust the cache settings to achieve a shorter lag time.
4. After using the Re-Amp function, we recommend **switching back to Normal mode**. Otherwise the pedal may boot up in Re-Amp mode when started the next time and there will be no signal from the guitar input as the input would still be set to USB input.

BLUETOOTH AUDIO

The GE1000 supports a Bluetooth connection to play back audio material from other devices such as Smartphones or tablets.

The Audio signal coming in over Bluetooth will be mixed with the signal from your guitar so you can use this feature for practice or to play along to an audio track.

- Open the GLOBAL SETTINGS screen on your **GE1000** by pressing the **SETTINGS** button and scroll down to **BLUETOOTH** to activate the Bluetooth function for the GE1000.
- Open the Bluetooth settings of your **mobile device** and make sure Bluetooth is active.
- Find "GE1000" in the list of available devices. 
- Click "Connect" to be able to play music through the Bluetooth input of the GE1000.
- **Use the volume controls on your device** to control the input volume at the GE1000 and thus the mix of the Bluetooth audio and the audio generated by your guitar playing through the GE1000.

GLOBAL SETTINGS

The GLOBAL SETTINGS screen can be accessed by pressing the **SETTINGS** button or by clicking the **settings icon** at the bottom of the Edit View. Other global settings can be accessed by clicking the **input or output indicators** on the upper edge of the Edit View.

Return to the previous screen by clicking the "X" in the upper right corner or by pressing the HOME button.

Global input settings

Click the input level indicator in the Edit View to open the global input settings screen.



The **INPUT gain** can be adjusted on the left side of the pop-up window. Use it to compensate for strong signals from instrument pickups with different output characteristics or from signal amplifying pedals (boost, overdrive, distortion ...) in front of the GE1000.

You can get visual confirmation of the input level by watching the **input level indication bar** on the screen or by watching the **input level LED** at the beginning of the row of physical effect module buttons.

A green indication is OK, a red indication means that the input signal is clipping i.e. distorted.

Note: Adjusting the global input level can prevent input distortion caused by exceedingly powerful input signals.

Use the global **NOISE REDUCER** feature to adjust the noise floor according to the requirements of different environments. This can eliminate the need for tedious preset by preset adjustments.

Global output settings

Click the output indicator in the Edit View to open the global output settings screen.



You can get visual confirmation of the output level at the end of the effect chain by watching the **output level indication bars** on the screen or by watching the **output level LED** at the end of the row of physical effect module buttons.

A green indication is OK, a red indication means that the output signal is clipping i.e. distorted.

1. Global output volume

You can use this page to set the output volume for each output interface individually, including the 1/4" output ports, the XLR output ports, the headphone jack and the USB digital recording output. Use these settings to establish the relative volume ratio between the different outputs.

The MASTER knob on the pedal will increase/decrease all outputs at the same time, but will maintain the ratios established here.



Select an output and slide the faders or rotate the SELECT knob for fine-tuning.

The **chain icon** below each group of faders is a left/right channel synchronization switch. When the icon is lit, the left and right channels of the respective group are synchronized. When the icon is off, the left and right channels of the group can be set independently.

2. Global equalization adjustment

Click the second page to access the GLOBAL EQ screen. Use this feature to quickly adjust the sound to the requirements of different venues and the frequency response characteristics of different amplification equipment. This is the best way to avoid tedious preset by preset adjustments.



3. Other function switches

Click the third page to set global function switches.

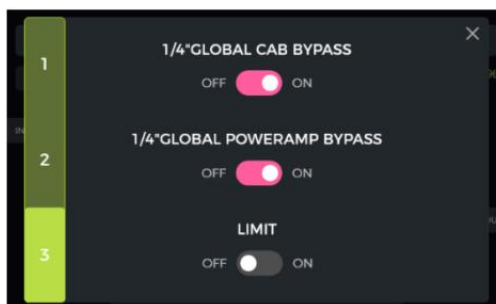

1/4" GLOBAL CABINET BYPASS: Global bypass for all analog cab simulation effects for the 1/4" outputs. If activated, the CAB module is automatically shifted to the end of the effect chain. This setting is applied to **all presets**.

1/4" GLOBAL POWER AMP BYPASS: Global bypass for all power amp simulation effects for the 1/4" outputs. If activated, the POWER AMP module is automatically shifted to the end of the effect chain. If "CAB BYPASS" and "POWERAMP BYPASS" are both activated, the POWER AMP module will be shifted to the end of the chain, but before the CAB module. This setting is applied to **all presets**.

These switches may be necessary for certain connection scenarios where different outputs with or without cabinet simulation (or amp simulation) are used. See section [*CONNECTION SCENARIOS*](#) for details.

GLOBAL LIMIT: Enable this switch to avoid digital signal clipping caused by the volume gain of an internal module exceeding the maximum dynamic range.

Screen Brightness

In some situations, you may want to adjust the screen brightness to adapt to different lighting environments, or to extend the battery life of the battery version.

According to test statistics, the battery life of the GE1000 Li (battery version) can be extended by almost one hour with 50% brightness instead of 100% and otherwise identical usage conditions.

Click the Settings icon on the main interface or press the SETTINGS button to open the settings, drag the BRIGHTNESS slider or rotate the SELECT knob to adjust screen brightness.

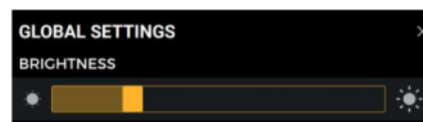

Preference section

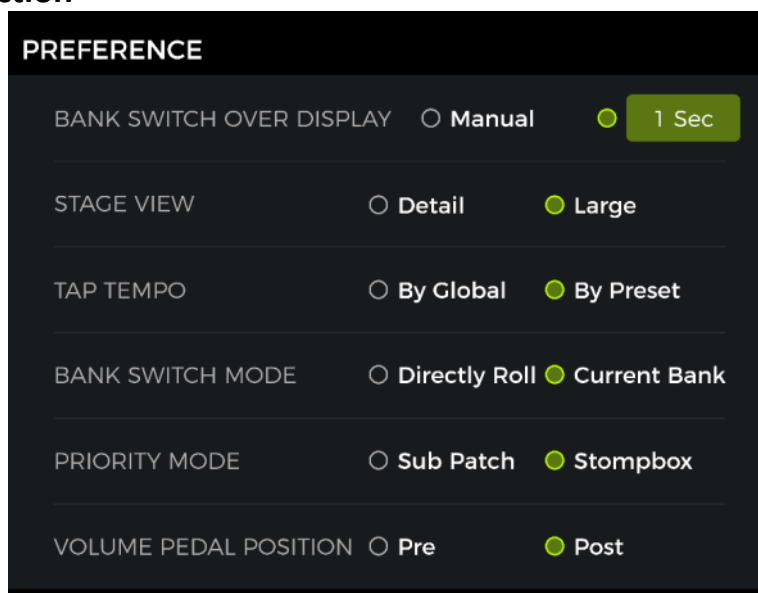

Bank switch timeout

This setting controls how the **bank selection view** switches back to the main interface after one of the BANK footswitches was pressed to select a different preset bank.

If set to "**Manual**", one of the A, B or C footswitches must be pressed (and therefore a preset within the bank selected) before the screen switches back to the main interface.

If a **time** is selected (open the drop-down menu by clicking the time field), the bank selection screen will be closed automatically after this time has elapsed. The previously used preset will still be active in this case. To change presets in the bank selection screen, you will have to tap one of the A, B or C footswitches before the selected time elapses.

Stage View display

Use this setting to select one of two Stage View types: "Detailed Display" or "Large Display".



Detailed display



Large display

Tap Tempo

This setting controls how the tap tempo input is used within the GE1000. When set to "Global", all presets are effected by a tap tempo input, when set to "Preset" every individual preset can have its own tap tempo input. You can also click the "Metronome" in the Edit View to access the same settings. (See [BPM tempo](#))

Bank Switch Mode

BANK SWITCH MODE Directly Roll Current Bank

Use this option to select between two switching modes:

Directly Roll means that when you press the Bank Down or Bank Up footswitch, the bank will change directly.

Current Bank means that when you press the Bank Down or Bank Up footswitch, it will switch to the bank preview display without directly switching to any other bank. You can then select a bank according to your requirements.

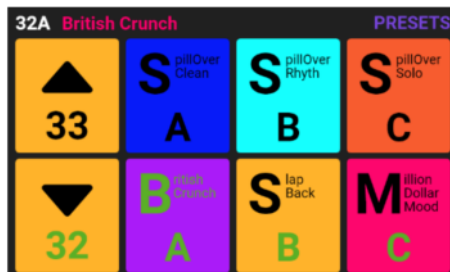

Current bank view

Priority Mode

PRIORITY MODE Sub Patch Stompbox

Use this setting to determine active sub-mode when you access the CTRL mode for the first time by stepping on the footswitch for the active preset.

When set to **Sub Patch**, the Sub Patch mode will be active, when set **Stompbox**, the Stompbox mode (Single or Multiple) will be active upon first activation of the CTRL mode.

Note that this setting is linked to the **Priority Mode** setting within the CTRL interface. (See [CTRL mode](#)).

Volume Pedal Position

VOLUME PEDAL POSITION Pre Post

Use this setting to determine the position of the volume pedal (Expression pedal used as volume pedal) with respect to the effects chain within the GE1000.

When set to **Pre**, the volume pedal will be placed at the very front of the effects chain.

Using this setting can maximize the preservation of the trails of some of your effect like delay and reverb in scenarios where the volume pedal is used.

When set to **Post**, the volume pedal will be placed at the very end of the effects chain.

Using this setting, the volume pedal will act as a master volume and the signal can be completely muted with the pedal moved to its minimum value.

The default for this setting option is **Post**.

Spill-Over (Effect Trails)

The GE1000 supports the trail hold function for delay and reverb effects.

Under some conditions, the natural decay of delay repeats or reverb echoes can be maintained when a corresponding module in is toggled on/off within a preset or when a different preset is activated:

Trails when modules are switched ON/OFF within a preset:

This type of ON/OFF switching while playing is usually accomplished using the CTRL mode, the EXP1 toe switch or a MIDI command from an external controller (see [Toe Switch Mapping](#) for the EXP1 pedal, [CTRL Mode](#) or [MIDI](#).)

- Open the parameter editing interface of the delay or reverb module in the preset.



- Find the "Trail" parameter and activate it.

Trails when switching presets:

This type of switching is accomplished by using the BANK, A, B or C footswitches or external MIDI commands to change presets.

- Find SPILL-OVER in the GLOBAL SETTINGS and activate it.
- Copy a target preset and save it to the position you want to switch to.
- In the new preset position, you can change the module switching status, or adjust different parameter settings according to the sound requirements.
- After completing these settings, you can switch between these two presets and maintain the natural decay of the delay and reverb tails.



Note: The trails feature does not support switching between two different effect chains or selecting different delay and reverb effect models.

Language Selection

The GE1000 supports menus in Chinese and in English. Scroll down to "Language" in the settings screen to select the desired language.



Factory reset

If required, settings can be partially or fully restored to factory values.

Open the GLOBAL SETTINGS screen, scroll down to FACTORY RESET and select the settings you want to re-set. Click **RESET** to confirm.

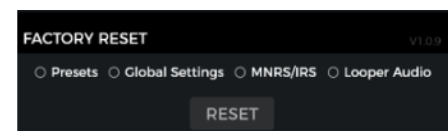

- **Presets:** Only the preset data will be restored to factory settings. All sounds you may have created or imported after purchasing the GE1000 will be deleted.
- **Global Settings:** Personalized settings such as screen brightness, preference settings, MIDI mappings, USB audio settings, trails and language settings will be restored to factory defaults.
- **MNRS/IRS:** All imported MNRS samples as well as GIR and IR sample data will be deleted.
- **Looper audio:** All audio recordings made with the Looper function will be deleted.

MIDI

The GE1000 is equipped with a 5-pin MIDI interface, and can be configured to send MIDI commands (MIDI OUT) or to receive them (MIDI IN). MIDI settings are global settings and apply to all presets.

Open the Settings screen by pressing the **SETTINGS knob** or by clicking the **settings icon** and scroll down to the MIDI settings.

Select "**Controller**" to configure the GE1000 as a **MIDI controller**, sending commands to other connected MIDI devices to control preset switching and other functions.

Select "**Slave**" to configure the GE1000 as a **controlled device** that receives control commands from other MIDI devices.

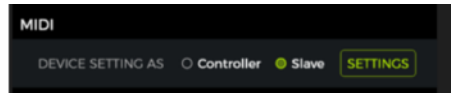

Supported MIDI commands

MIDI command	Send	Receive
Channel	1 -16	1- 16, Omni
MIDI Note	Not supported	Not supported
Program Change (PC)	supported	supported
Continuous Control (CC)	Not supported	supported
Synchronization	MIDI Clock supported	MIDI Clock supported
other	Not supported	Not supported

GE1000 as controlled device

To configure the GE1000 as a controlled device, press the SETTINGS knob, scroll down to MIDI, select "Slave" and click "Settings" to enter the configuration page. The following options are provided:

MIDI Channel

Click CHANNEL and select the MIDI command channel that the GE1000 is supposed to respond to. The factory default is channel 1.

OMNI means the GE1000 will ignore the channel information and respond to the command directly. This simply means that no matter what channel is set by the transmitting device, the GE1000 will respond to the corresponding MIDI command.



CC Mapping

In this list, you can set the function for each received CC code. The factory default is "Empty".

You can choose from a list of functions, depending on your needs.

The following functions can be controlled with CC commands (this list may be incomplete and the items may not be listed in the same order as in the on-screen menu).

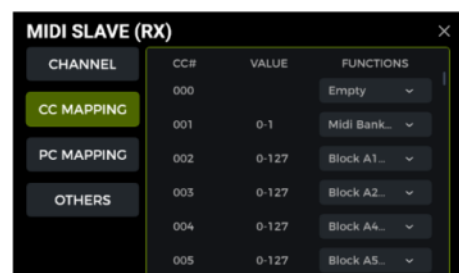

Function	Value	Comments
Empty	none	No function selected
MIDI Bank Select	0, 1	Corresponds to switching between two banks within the PC list, with 128 presets mapped to each bank (see PC Mapping below).
Block A1 – B7 toggle	0 - 127	Toggles the effect module in the specified position of the effects chain ON/OFF. Block A includes positions 1-7 of the effect chain. Block B includes positions 8-14.
Patch Level	0 - 127	This corresponds to controlling the PATCH LEVEL (preset volume) in the Edit View.
Tap Tempo	0 - 127	This command is sent to the GE1000 continuously, and the interval is used as the value for the tempo setting.
Input level	0 - 127	Controls the input volume in the Global Input settings.
Noise Reducer	0 - 127	Corresponds to the Noise Reduction switch in the Global Input settings.
1/4" output level	0 - 127	Controls the volume of the 1/4" output in the Global Output settings.
XLR output level	0 - 127	Corresponds to control the volume of the XLR output in the Global Output settings.
Phones output level	0 - 127	Controls the volume of the headphone output in the Global Output settings.
USB output level	0 - 127	Corresponds to the volume of the USB audio output in the Global Output settings.
Groove Station enter/exit	0 - 127	Open / close the Groove Station.
Tuner enter/exit	0 - 127	Open / close the Tuner screen.
Global EQ toggle	0 - 127	Corresponds to the Global EQ switch in the Global Output settings.
1/4" global cab switch	0 - 127	Corresponds to the 1/4" Global Cab Bypass switch in the Global Output settings.
1/4" global power amp on/off	0 - 127	Corresponds to the 1/4" Global Power Amp Bypass switch in the Global Output settings.
Global Limit Switch	0 - 127	Corresponds to the Global Limit switch in the Global Output settings.
Looper REC/DUB/PLAY	0 - 127	Corresponds to pressing the BANK ▼ footswitch in Groove Station mode.
Looper Stop	0 - 127	This command executes the STOP command for the Looper, which is equivalent to pressing the A footswitch in Groove Station mode.
Looper Clear	0 - 127	This command executes the CLEAR command for the Looper, which is equivalent to long-pressing the A footswitch in Groove Station mode.
Drum sync on/off	0 - 127	This command toggles Drum Machine Synchronization in Groove Station mode on/off.
Tuner bypass/mute	0 - 127	This command toggles bypass / mute tuning for the Tuner function.
Exp 1 on/off	0 - 127	This command is equivalent to pressing the toe switch on the EXP1 pedal.
Exp 1 Pedal	0 - 127	This corresponds to moving the EXP 1 pedal.
Footswitch mode	0 - 127	Send this command to switch the sub mode in CTRL mode
Stompbox Control A	0 - 127	Send this command to switch Stompbox A in CTRL mode
Stompbox Control B	0 - 127	Send this command to switch Stompbox B in CTRL mode
Stompbox Control C	0 - 127	Send this command to switch Stompbox C in CTRL mode
Sub Patch 1	0 - 127	Send this command to toggle Sub Patch 1 in CTRL mode
Sub Patch 2	0 - 127	Send this command to toggle Sub Patch 2 in CTRL mode
Sub Patch 3	0 - 127	Send this command to toggle Sub Patch 3 in CTRL mode

PC mapping

This list corresponds to the preset numbers that can be controlled by PC codes from two MIDI banks (0 and 1). The individual settings can be changed by the user.

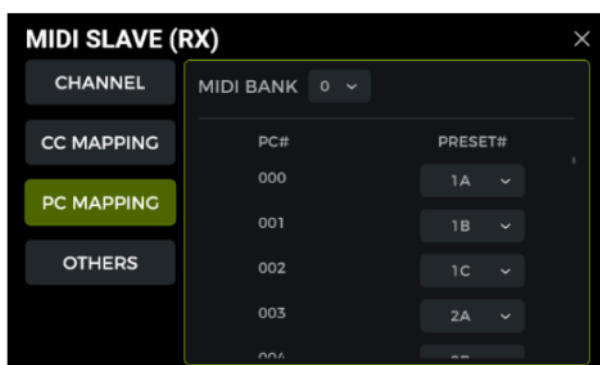

List of default factory settings:

MIDI bank	PC code	Preset No.	MIDI bank	PC code	Preset No.	MIDI bank	PC code	Preset No.	MIDI bank	PC code	Preset No.
0	0	1A	0	32	11C	0	64	22B	0	96	33A
0	1	1B	0	33	12A	0	65	22C	0	97	33B
0	2	1C	0	34	12B	0	66	23A	0	98	33C
0	3	2A	0	35	12C	0	67	23B	0	99	34A
0	4	2B	0	36	13A	0	68	23C	0	100	34B
0	5	2C	0	37	13B	0	69	24A	0	101	34C
0	6	3A	0	38	13C	0	70	24B	0	102	35A
0	7	3B	0	39	14A	0	71	24C	0	103	35B
0	8	3C	0	40	14B	0	72	25A	0	104	35C
0	9	4A	0	41	14C	0	73	25B	0	105	36A
0	10	4B	0	42	15A	0	74	25C	0	106	36B
0	11	4C	0	43	15B	0	75	26A	0	107	36C
0	12	5A	0	44	15C	0	76	26B	0	108	37A
0	13	5B	0	45	16A	0	77	26C	0	109	37B
0	14	5C	0	46	16B	0	78	27A	0	110	37C
0	15	6A	0	47	16C	0	79	27B	0	111	38A
0	16	6B	0	48	17A	0	80	27C	0	112	38B
0	17	6C	0	49	17B	0	81	28A	0	113	38C
0	18	7A	0	50	17C	0	82	28B	0	114	39A
0	19	7B	0	51	18A	0	83	28C	0	115	39B
0	20	7C	0	52	18B	0	84	29A	0	116	39C
0	21	8A	0	53	18C	0	85	29B	0	117	40A
0	22	8B	0	54	19A	0	86	29C	0	118	40B
0	23	8C	0	55	19B	0	87	30A	0	119	40C
0	24	9A	0	56	19C	0	88	30B	0	120	41A
0	25	9B	0	57	20A	0	89	30C	0	121	41B
0	26	9C	0	58	20B	0	90	31A	0	122	41C
0	27	10A	0	59	20C	0	91	31B	0	123	42A
0	28	10B	0	60	21A	0	92	31C	0	124	42B
0	29	10C	0	61	21B	0	93	32A	0	125	42C
0	30	11A	0	62	21C	0	94	32B	0	126	43A
0	31	11B	0	63	22A	0	95	32C	0	127	43B

MIDI bank	PC code	Preset No.	MIDI bank	PC code	Preset No.	MIDI bank	PC code	Preset No.	MIDI bank	PC code	Preset No.
1	0	43C	1	32	54B	1	64	65A	1	96	75C
1	1	44A	1	33	54C	1	65	65B	1	97	76A
1	2	44B	1	34	55A	1	66	65C	1	98	76B
1	3	44C	1	35	55B	1	67	66A	1	99	76C
1	4	45A	1	36	55C	1	68	66B	1	100	77A
1	5	45B	1	37	56A	1	69	66C	1	101	77B
1	6	45C	1	38	56B	1	70	67A	1	102	77C
1	7	46A	1	39	56C	1	71	67B	1	103	78A
1	8	46B	1	40	57A	1	72	67C	1	104	78B
1	9	46C	1	41	57B	1	73	68A	1	105	78C
1	10	47A	1	42	57C	1	74	68B	1	106	79A
1	11	47B	1	43	58A	1	75	68C	1	107	79B
1	12	47C	1	44	58B	1	76	69A	1	108	79C
1	13	48A	1	45	58C	1	77	69B	1	109	80A
1	14	48B	1	46	59A	1	78	69C	1	110	80B
1	15	48C	1	47	59B	1	79	70A	1	111	80C
1	16	49A	1	48	59C	1	80	70B	1	112	81A
1	17	49B	1	49	60A	1	81	70C	1	113	81B
1	18	49C	1	50	60B	1	82	71A	1	114	81C
1	19	50A	1	51	60C	1	83	71B	1	115	82A
1	20	50B	1	52	61A	1	84	71C	1	116	82B
1	21	50C	1	53	61B	1	85	72A	1	117	82C
1	22	51A	1	54	61C	1	86	72B	1	118	83A
1	23	51B	1	55	62A	1	87	72C	1	119	83B
1	24	51C	1	56	62B	1	88	73A	1	120	83C
1	25	52A	1	57	62C	1	89	73B	1	121	84A
1	26	52B	1	58	63A	1	90	73C	1	122	84B
1	27	52C	1	59	63B	1	91	74A	1	123	84C
1	28	53A	1	60	63C	1	92	74B	1	124	85A
1	29	53B	1	61	64A	1	93	74C	1	125	85B
1	30	53C	1	62	64B	1	94	75A	1	126	85C
1	31	54A	1	63	64C	1	95	75B	1	127	-

Other settings

Use this page to activate/disable MIDI CLOCK SYNC for incoming MIDI commands and to activate/disable USB MIDI.

MIDI Clock: When active, tempo-based features of the main Edit View will be synchronized to the MIDI clock commands sent by the external device.

USB MIDI: Enable this feature to receive MIDI commands from a computer through the USB-C interface.

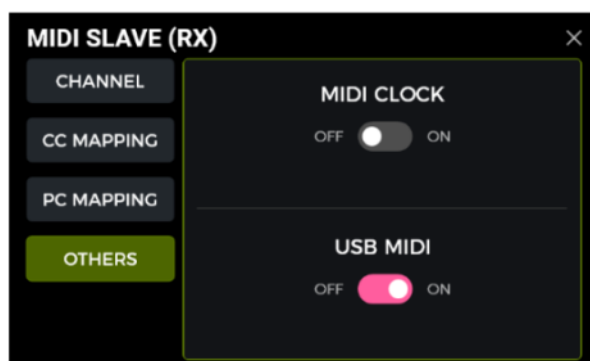

GE1000 as controlling device

To configure the GE1000 as a MIDI controller, press the SETTINGS button, scroll down to MIDI, select "Controller" and click "Settings" to enter the configuration page. The following options are provided:

MIDI Channel

Click CHANNEL and select the MIDI channel the GE1000 will use to send commands. The factory default is Channel 1.



PC mapping

This list corresponds to the PC codes in two MIDI banks (0 and 1) that the GE1000 can send.

The individual settings can be changed by the user.

After switching to a preset, the GE1000 will send CC0 (MIDI bank information) + the PC command to the receiving device.

List of default factory settings:

Preset No.	MIDI bank	PC command	Preset No.	MIDI bank	PC command	Preset No.	MIDI bank	PC command	Preset No.	MIDI bank	PC command
1A	0, 1	0	11C	0, 1	32	22B	0, 1	64	33A	0, 1	96
1B	0, 1	1	12A	0, 1	33	22C	0, 1	65	33B	0, 1	97
1C	0, 1	2	12B	0, 1	34	23A	0, 1	66	33C	0, 1	98
2A	0, 1	3	12C	0, 1	35	23B	0, 1	67	34A	0, 1	99
2B	0, 1	4	13A	0, 1	36	23C	0, 1	68	34B	0, 1	100
2C	0, 1	5	13B	0, 1	37	24A	0, 1	69	34C	0, 1	101
3A	0, 1	6	13C	0, 1	38	24B	0, 1	70	35A	0, 1	102
3B	0, 1	7	14A	0, 1	39	24C	0, 1	71	35B	0, 1	103
3C	0, 1	8	14B	0, 1	40	25A	0, 1	72	35C	0, 1	104
4A	0, 1	9	14C	0, 1	41	25B	0, 1	73	36A	0, 1	105
4B	0, 1	10	15A	0, 1	42	25C	0, 1	74	36B	0, 1	106
4C	0, 1	11	15B	0, 1	43	26A	0, 1	75	36C	0, 1	107
5A	0, 1	12	15C	0, 1	44	26B	0, 1	76	37A	0, 1	108
5B	0, 1	13	16A	0, 1	45	26C	0, 1	77	37B	0, 1	109
5C	0, 1	14	16B	0, 1	46	27A	0, 1	78	37C	0, 1	110
6A	0, 1	15	16C	0, 1	47	27B	0, 1	79	38A	0, 1	111
6B	0, 1	16	17A	0, 1	48	27C	0, 1	80	38B	0, 1	112
6C	0, 1	17	17B	0, 1	49	28A	0, 1	81	38C	0, 1	113
7A	0, 1	18	17C	0, 1	50	28B	0, 1	82	39A	0, 1	114
7B	0, 1	19	18A	0, 1	51	28C	0, 1	83	39B	0, 1	115
7C	0, 1	20	18B	0, 1	52	29A	0, 1	84	39C	0, 1	116
8A	0, 1	21	18C	0, 1	53	29B	0, 1	85	40A	0, 1	117
8B	0, 1	22	19A	0, 1	54	29C	0, 1	86	40B	0, 1	118
8C	0, 1	23	19B	0, 1	55	30A	0, 1	87	40C	0, 1	119
9A	0, 1	24	19C	0, 1	56	30B	0, 1	88	41A	0, 1	120
9B	0, 1	25	20A	0, 1	57	30C	0, 1	89	41B	0, 1	121
9C	0, 1	26	20B	0, 1	58	31A	0, 1	90	41C	0, 1	122
10A	0, 1	27	20C	0, 1	59	31B	0, 1	91	42A	0, 1	123
10B	0, 1	28	21A	0, 1	60	31C	0, 1	92	42B	0, 1	124
10C	0, 1	29	21B	0, 1	61	32A	0, 1	93	42C	0, 1	125
11A	0, 1	30	21C	0, 1	62	32B	0, 1	94	43A	0, 1	126
11B	0, 1	31	22A	0, 1	63	32C	0, 1	95	43B	0, 1	127

Preset No.	MIDI bank	PC command	Preset No.	MIDI bank	PC command	Preset No.	MIDI bank	PC command	Preset No.	MIDI bank	PC command
43C	0, 1	0	54B	0, 1	32	65A	0, 1	64	75C	0, 1	96
44A	0, 1	1	54C	0, 1	33	65B	0, 1	65	76A	0, 1	97
44B	0, 1	2	55A	0, 1	34	65C	0, 1	66	76B	0, 1	98
44C	0, 1	3	55B	0, 1	35	66A	0, 1	67	76C	0, 1	99
45A	0, 1	4	55C	0, 1	36	66B	0, 1	68	77A	0, 1	100
45B	0, 1	5	56A	0, 1	37	66C	0, 1	69	77B	0, 1	101
45C	0, 1	6	56B	0, 1	38	67A	0, 1	70	77C	0, 1	102
46A	0, 1	7	56C	0, 1	39	67B	0, 1	71	78A	0, 1	103
46B	0, 1	8	57A	0, 1	40	67C	0, 1	72	78B	0, 1	104
46C	0, 1	9	57B	0, 1	41	68A	0, 1	73	78C	0, 1	105
47A	0, 1	10	57C	0, 1	42	68B	0, 1	74	79A	0, 1	106
47B	0, 1	11	58A	0, 1	43	68C	0, 1	75	79B	0, 1	107
47C	0, 1	12	58B	0, 1	44	69A	0, 1	76	79C	0, 1	108
48A	0, 1	13	58C	0, 1	45	69B	0, 1	77	80A	0, 1	109
48B	0, 1	14	59A	0, 1	46	69C	0, 1	78	80B	0, 1	110
48C	0, 1	15	59B	0, 1	47	70A	0, 1	79	80C	0, 1	111
49A	0, 1	16	59C	0, 1	48	70B	0, 1	80	81A	0, 1	112
49B	0, 1	17	60A	0, 1	49	70C	0, 1	81	81B	0, 1	113
49C	0, 1	18	60B	0, 1	50	71A	0, 1	82	81C	0, 1	114
50A	0, 1	19	60C	0, 1	51	71B	0, 1	83	82A	0, 1	115
50B	0, 1	20	61A	0, 1	52	71C	0, 1	84	82B	0, 1	116
50C	0, 1	21	61B	0, 1	53	72A	0, 1	85	82C	0, 1	117
51A	0, 1	22	61C	0, 1	54	72B	0, 1	86	83A	0, 1	118
51B	0, 1	23	62A	0, 1	55	72C	0, 1	87	83B	0, 1	119
51C	0, 1	24	62B	0, 1	56	73A	0, 1	88	83C	0, 1	120
52A	0, 1	25	62C	0, 1	57	73B	0, 1	89	84A	0, 1	121
52B	0, 1	26	63A	0, 1	58	73C	0, 1	90	84B	0, 1	122
52C	0, 1	27	63B	0, 1	59	74A	0, 1	91	84C	0, 1	123
53A	0, 1	28	63C	0, 1	60	74B	0, 1	92	85A	0, 1	124
53B	0, 1	29	64A	0, 1	61	74C	0, 1	93	85B	0, 1	125
53C	0, 1	30	64B	0, 1	62	75A	0, 1	94	85C	0, 1	126
54A	0, 1	31	64C	0, 1	63	75B	0, 1	95	-	-	-

Other settings

Use this page to activate/disable MIDI CLOCK SYNC for outgoing MIDI commands and to activate/disable USB MIDI.

MIDI Clock: When active, MIDI clock commands are sent out based on the GE1000's current BPM tempo.

USB MIDI: Enable this feature to send MIDI commands through the USB-C interface.

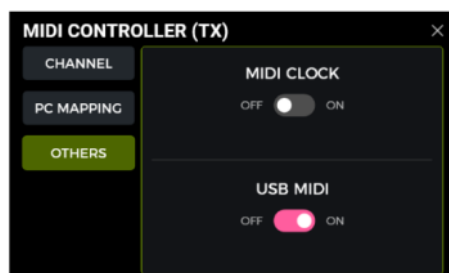

F4 WIRELESS FOOTSWITCH

For extended control options, the GE1000 supports a connection to a MOOER F4 wireless footswitch (to be purchased separately).

Please consult the manual for the F4 footswitch for battery specs and charging requirements.

The GE1000 can only be connected to one wireless footswitch at a time.

Before using the footswitch for the first time (or after a factory reset), please follow the steps below to pair the footswitch with the GE1000:

- Switch the F4 footswitch on, press and hold footswitches **A** and **C** simultaneously to enter pairing mode (LED blinking).
- Open the settings screen on the GE1000 and scroll down to the "**F4 WIRELESS FOOTSWITCH**" option.
- Activate "**Wireless footswitch**" and click "**Start Pairing**".

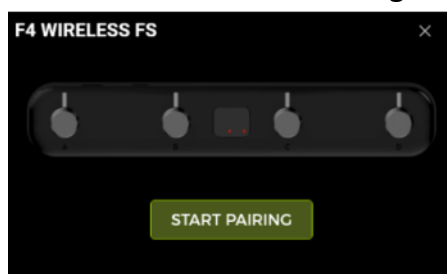

- When the pairing is successful, the GE1000 shows the "**Paired**" icon in the top right corner and the display on the F4 footswitch shows "**On**".
- Once paired, the wireless footswitch will automatically connect to the GE1000 each time both devices are turned on and within range of each other.

Note: You can click the PAIRED icon to disconnect the F4 Footswitch.

Configuring the wireless footswitch

After the F4 is paired, press the wireless footswitch icon below the effect chain, or enter the GLOBAL SETTING menu to configure the wireless footswitch. The wireless footswitch menu opens where you can select the functions you wish to control with each footswitch.



Wireless footswitch settings menu

Available functions for the wireless footswitch

The following functions can be assigned to each footswitch of the F4:

Num.	Function	Description
1	Empty	no function
2	Preset A	Switch to preset A of the current bank.
3	Preset B	Switch to preset B of the current bank.
4	Preset C	Switch to preset C of the current bank.
5	Preset Up	Switch Up between presets.
6	Preset Down	Switch Down between presets.
7	Bank Up	Switch Up between preset banks.
8	Bank Down	Switch Down between preset banks.
9	Tuner	Enter the TUNER mode, the wireless footswitch LED will flash slowly. Press any footswitch to quit.
10	TAP	TAP function: press the footswitch several times to set the tempo. The wireless footswitch LED will flash to indicate the selected tempo.
11	Tap Mode	Corresponds to the Tap Mode switching function in the CTRL interface;
12	Stompbox A	Corresponds to the function of Stompbox A in CTRL mode
13	Stompbox B	Corresponds to the function of Stompbox B in CTRL mode
14	Stompbox C	Corresponds to the function of Stompbox C in CTRL mode
15	Groove Station Down	Down footswitch in Groove Station mode.
16	Groove Station A	Footswitch A in the Groove Station mode.
17	Groove Station B	Footswitch B in the Groove Station mode.
18	Groove Station C	Footswitch C in the Groove Station mode.
19	Sub Patch 1	Corresponds to the Sub Patch 1 function in CTRL mode
20	Sub Patch 2	Corresponds to the Sub Patch 2 function in CTRL mode
21	Sub Patch 3	Corresponds to the Sub Patch 3 function in CTRL mode

This means that, depending on the functions you have assigned, you can use the wireless footswitch at any time to individually activate/deactivate the selected function without actually opening the respective mode.

MOOER STUDIO Software

MOOER STUDIO is the computer editor software for MOOER intelligent series products. Users can edit parameters and manage the data (firmware updates, upload/download presets, import of GNR/GIR/IR files, backup/restore presets, audio file loading).

Software download

Visit the official MOOER AUDIO website (www.moeraudio.com) and navigate to the DOWNLOAD area. Find the "GE1000" page, download the appropriate installation program for your operating system (Windows or Mac) and install it.

System requirements:

- Windows-Win10 or above
- Mac OS-10.11 or above

Establishing the connection

After the installation is complete, please use the USB cable to connect your GE1000 to the computer, open the editor software, and click on the CONNECT button to establish the connection.

Data Management Menu Layout

The screenshot shows the MOOER STUDIO software interface with several annotated sections:

- Device info:** Shows the connected device, the connection status and the firmware version. Click to connect or disconnect.
- Software task area:** Choose between editing and managing features.
- Language:** Select a language from the drop-down menu. This setting also changes the language for the menus on the device.
- Feature selection:** Select a software feature: firmware update, GNR, GIR file loading, backup file loading and device language.
- Control area:** Open a control menu depending on the selection on the left side.

Firmware update

- Download the editor software with the new firmware version, install it, and connect your GE1000 to your computer.
- Find the UPDATE button in the left side area.
- Click on UPDATE to confirm, the device will be booted to update mode.
- Wait for a few minutes until the update is complete.

Note: To avoid unexpected issues, please do not power the device off or disconnect it.

GNR file import

GNR is the amp sample file based on the MNRS technology, which captures actual amplifier sound samples via GE LABS. MOOER devices supporting MNRS files can use the files downloaded from www.mooerstudio.com. Users can download the MNRS files to their computer, and then load them into the device for use.

- Click on GNR on the left side in the MOOER Studio Software.
- Select the file you wish to load into the list. (The list corresponds to the GNR list in the amp model module in the GE1000.)
- Click OK to import the selected GNR file.

You will then find the sample file in the section showing imported samples in the AMP-GNR list.

GIR/IR import

GIR and IR files are based on impulse response technology for cabinet simulations. The standard format for IR files is “wav”. GIR files are captured from an actual cabinet via GE LABS. Both file types can be loaded into the empty slots of the GIR list in CAB modules in the GE1000.

You can get IR files from third parties, visit www.mooerstudio.com to download GIR files to your computer.

- Select the third-party IRs option on the left side of the software interface.
- Select the file you wish to load into the list. (The list corresponds to the GIR list in the amp model module in the GE1000.)
- Click OK to import the selected GIR file.

Data backup

The backup feature allows the user to make a complete backup of the device’s data, including preset patches, loaded GNR/GIR/IR files, global EQ settings, and recorded looper tracks. You can use this feature to quickly recall settings for different usage situations.

- Select **Backup** on the left side of the MOOER Studio software interface.
- Wait until the backup procedure finishes. You can then see the backup records in the backup area.
- Click **Restore** to quickly recall a backup file into your device.

Parameter editing interface

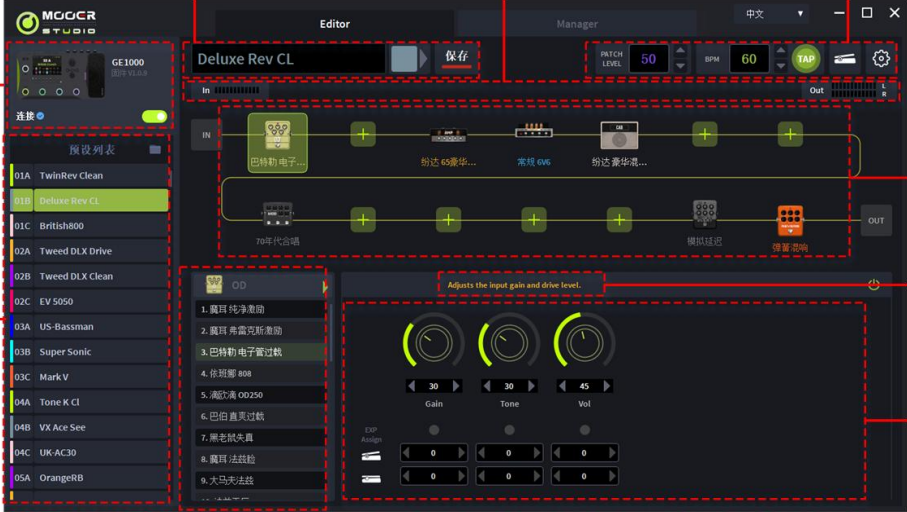

Preset save area
Edit and save preset name and color.

Input and output settings
Click input/output to open the respective settings window.

Preset and system settings
Shows current settings for preset volume, preset BPM, expression pedal setting and global EQ. Click to open the respective settings menus.

Effect chain area
Shows the effect chain of the current preset, including On/OFF status and order of modules.

Parameter area
Shows info for a module or parameter when the mouse is moved it. Info disappears when mouse is moved away.

Parameter adjustment
Adjust parameters for a selected module or change expression pedal mappings by clicking the small dot.

Device info
Shows the connected device, the connection status and the firmware version.

Preset list
This area shows all preset info in the current device. User can copy, rename.

Effect module selection
This area shows effect modules in each category. Click to change the effect module for the selected spot in the chain.

Preset management

- In the preset list area, you can click to select a preset patch or drag a patch to change the order of preset patches.
- Right-click on a preset patch to open a window where you can rename/copy/paste/import/export the preset. The exported preset file will be saved into the target file folder, click on the folder icon in the preset list to open the default folder.
- Users can right-click on a preset file to import it, or drag the file to the preset patch area, and click on CONFIRM to import the file into the device.

Preset editing

The effect modules can be found in the effect chain area, where you can see the order and the On/Off status of the individual effect modules.

- **Parameter adjustment:** Click on a module, the parameter window will pop up and you can adjust them directly.
- **Adding an effect module:** Click on the “+” icon to add a module to the effect chain, select an effect type and confirm.
- **Changing the order:** Select an effect module, hold it and drag it to the desired position.
- **Saving changes:** When any changes have been made in a preset patch, the saving icon in the preset saving area will flash as a reminder. After you confirm saving, the changes will be saved.

Expression pedal settings

You can find the expression pedal area at the bottom of the effect chain area. You can assign selected parameters to the expression pedal, and set minimum value and maximum value manually. Click on the expression pedal icon at the top-right corner to see all parameters controlled by the expression pedal. You can edit them directly.

On the right side of the expression pedal area, you can assign the function associated with pressing the pedal.

Note: The changes in the settings of the expression pedal must be saved manually into the preset patch.

Preset volume level and BPM settings

You can adjust the preset volume level and the BPM setting in the function setting area. You can use the TAP function for BPM setting: click the TAP icon several times to input a tempo.

When the tempo parameters of a Delay module or some of the Modulation modules are set to SYNC with TAP, they will all sync with the TAP value you have set.

Note: In the GLOBAL SETTINGS menu, you can set the TAP tempo as global TAP input or as TAP input for the current Preset.

Input & Output Settings

Click on the Input & Output area, and drag the bar to adjust the input/output volume levels.

- In the input setting menu, you can adjust the input volume level and global noise gate settings.
- In the output setting menu, you can adjust the volume level for each output, the global EQ as well as global settings for Cab and Power Amp simulations.

Global Settings

Click on the GLOBAL SETTINGS icon to open the menu. Use this menu to adjust settings for the brightness of the display, preferences, effect trails, USB Audio and factory reset.

TROUBLESHOOTING

The GE1000 does not start

- Ensure that the original power adapter is connected.
- GE1000 Li (battery-powered version): Make sure the battery still has sufficient charge to meet the power demands during boot-up. Connect the original adapter before trying to start the device.
- The Power button should be pressed for more than 2 seconds.

No sound after startup

- Check that the MASTER volume knob on the panel is turned to the proper position.
- Click the "INPUT LEVEL" indicator in the Edit View to make sure the input gain fader is in the proper position.
- Click the "OUTPUT LEVEL" indicator in the Edit View to check that each output fader is in the proper position.
- Check that the "PATCH LEVEL" is properly set.
- Check whether the EXP1 pedal is in volume mode (the GE1000 logo light on the left side of the pedal is off), and move the pedal to the "toe down" position.
- Check that the "USB Audio Interface" in the "Settings" menu is in "Normal" mode. "Re-AMP" mode will switch the source of the signal input to USB and cause the normal input to be silent.

Low frequency hum

- Please use signal cables with good shielding.
- Change the usage environment or the time of usage to determine if the noise is caused by interference from sources in the environment.
- Keep a distance from computers, motors, fans and other electrical appliances to reduce electromagnetic interference.
- Toggle the GND / LIFT switch to eliminate ground-loop based noise.

SPECIFICATIONS

Effects

Number of module types	11
Total number of effect models	more than 340
Preset storage slots	255

Impulse Response

Supported formats	WAV
Sampling rate	44.1 kHz
Sampling accuracy	24 bit
Number of sample points	Up to 2048 sampling points

Inputs

INPUT jack

Interface type	1 x 1/4" unbalanced stereo input connector
Input impedance	1 MOhm
Maximum input level	10 dBu

RETURN jack

Interface type	1 x 1/4" unbalanced mono input connector
Input impedance	1 MOhm
Maximum input level	10 dBu

Audio Analog-to-Digital Converter

Sampling rate	44.1 kHz
Sampling accuracy	24 bit
Dynamic range	114 dB
Frequency response	20 Hz - 20 kHz, +0 / -1 dB

Outputs

OUTPUT jack

Interface type	Two 1/4" unbalanced mono output jacks
Output impedance	600 Ohm
Maximum output level	18 dBu

XLR connector

Interface type	2 x balanced signal XLR output jacks
Output Impedance	600 Ohm
Maximum output level	18 dBu

SEND jack

Interface type	1 x 1/4" unbalanced stereo output connector
Output Impedance	510 Ohm
Maximum output level	18 dBu

PHONES jack

Interface type	1 x 1/8" unbalanced stereo output connector
Output impedance	6 Ohm
Maximum output level	18 dBu

Audio DAC

Dynamic range	115 dB
Frequency response	20 Hz - 20 kHz, +0 / -1 dB
Signal-to-noise ratio	115 dB

Misc

MIDI interface

MIDI IN or MIDI OUT 1 x 5-pin female connector

USB port

Interface type TYPE-C connector

USB Audio

Interface type USB2.0, 2 in 2 out, 44.1 - 192 kHz, 24bit

TYPE-C connector

General

Power Supply

GE1000: DC 9 V, 1 A, negative center

GE1000 Li: DC 9 V, 3 A, negative center

Battery (GE1000 Li)

Li-ion, rechargeable, 4750 mAh, 35.15 Wh, 7.4 V

Battery life (GE1000 Li)

Approx. 6 hours (at 50% screen brightness, 25°C)

Charging time (GE1000 Li)

Approx. 2.5 hours (using original adapter, device turned off)

Dimensions

337 mm × 170 mm × 57 mm (LxWxH)

Weight

GE1000: 1.9 kg / GE1000 Li: 2.0 kg

Accessories

Power adapter, USB cable, Quick guide

Disclaimer: Parameter updates will not be notified separately.

ANNEX 1: EFFECT DESCRIPTIONS

Dynamic modules

Effect Description		
No.	Model name	Description
1	S-Comp	Dual-parameter adjustable compressor.
2	Red Comp	Dual-parameter compressor.
3	Yellow Comp	Based on MOOER® YELLOW COMP compressor with four parameters.
4	Blue Comp	Compressor based on MOOER® BLUE COMP with four parameters.
5	Boost Comp	Compressor / Booster effect with three-band equalization.
6	L-Studio Comp	Vintage analog studio compressor.
7	Deluxe Comp	Modern analog studio compressor.
8	3-Band Comp	80s studio digital compressor.
9	Limit	Dual-parameter limiter.
10	Blood Comp	Three parameter compressor with adjustable blend ratio.
11	Noise Killer	Hard noise gate based on the Mooer® Micro Noise Killer. The effect solves noise issues quickly and efficiently with simple threshold adjustments.
12	Intel Reducer	Unlike conventional noise gates, this works by separating the conventional signal from the white noise in the signal and eliminating the white noise to achieve noise reduction while maintaining natural decay. This module is recommended for use before distortion effects or speaker simulation.
13	Noise Gate	Four parameter studio noise gate. The user can adjust the effective threshold according to the current noise level, then adjust the appropriate attack and release according to their needs, and finally select the appropriate damping.

Parameter Descriptions		
No.	Parameter	Description
1	Sensitivity	Adjusts the amount of compression. 0 = no compression.
2	Output	Adjusts the output volume of the compressor.
3	Attack	The startup time of the dynamic effect after the signal exceeds the set threshold. 100 = slowest attack, 0 = fastest attack.
4	Ratio	Compression Ratio. The ratio of input level to output level after the threshold is exceeded. A larger ratio produces a more pronounced compression effect, to a certain extent.
5	Threshold	Level threshold for triggering dynamic effects. The smaller the value, the easier it is to trigger, and at approximately 0 dB it is turned off.
6	Depth	Intel Reducer module's white noise suppression strength, the larger the value, the stronger the suppression strength.
7	Comp	Adjusts the amount of compression in a compression module. The larger the value, the more obvious the compression effect.
8	Low	Low frequency adjustment for the Boost compressor.
9	High	High frequency adjustment for the Boost compressor.
10	Gain	Adjusts gain at the output of the compressor.
11	Peak Reduction	Adjusts the amount of compression.
12	Mix	Mixing ratio of uncompressed signal and compressed signal. 0 = uncompressed signal only, 100 = compressed signal only
13	Release	The time it takes for the signal to return to normal from the compressed state after the input level falls below the set threshold. The larger the value, the longer the time.
14	Low Threshold	Low frequency threshold for the 3-band compressor.
15	Low Gain	Low frequency gain for the 3-band compressor.
16	Mid Threshold	Mid-range frequency threshold for the 3-band compressor.

17	Mid Gain	Mid-range gain for the 3-band compressor.
18	High Threshold	High frequency threshold for the 3-band compressor.
19	High Gain	High frequency gain for the 3-band compressor.
20	Sustain	Adjusts the amount of compression.
21	Blend	Adjusts the volume of the compressed signal. 0 = uncompressed signal only, 100 = compressed signal only
22	Damp	Adjusts how much the gate attenuates the noise when it is closed.

Filter modules

Effect Description		
No.	Model name	Description
1	Cry Wah	Modeled after a GCB95.
2	535 Wah	Modeled after a modern 535Q.
3	846 Wah	Modeled after a hand wired 60's classic with Halo inductor.
4	847 Wah	Modeled after a vintage voiced remake.
5	Mae Wah	Modeled after a custom modern Wah.
6	Custom Wah	Studio rack style unit. Tailor your perfect Wah.
7	Auto Wah	Modulated automatic sweeping Wah.
8	Touch Wah	Dynamic envelope filter auto Wah.
9	Talk Wah Ah	Talking Wah algorithm from the MOOER® Red Kid.
10	Talk Wah Oh	Talking Wah algorithm from the MOOER® Red Kid.
11	Low Pass Filter	Static low frequency pass filter.
12	High Pass Filter	Static high frequency pass filter.
13	Q-Filter	Static notch filter (like a half cocked Wah pedal).

Parameter Description		
No.	Parameter	Description
1	Peak	Controls the height of the resonance peak.
2	Rate	Adjusts the speed of the position sweep LFO.
3	Range	Adjusts the range of the position sweep.
4	Q	The Q or "Quality factor" is the ratio of the resonant frequency to the bandwidth, between the upper and lower -3dB frequencies. In this particular application, you can think of the Q as the shape of your band pass filter. A low Q will have a wider, rounder shape and sound less pronounced. A high Q will have a narrower, sharper shape and sound more pronounced.
5	Mix	Sets the proportion of mix between the original (dry) and 'effected' (wet) signals. 0 is total dry signal, 100 is total wet signal.
6	Position	The position of the Wah in its pedal sweep. 0 is equal to heel down, 100 is equal to toe down. *Notes: If you want to use the EXP pedal to control the Wah sweep, assign "WAH > Position" as the function in the EXP menu. You can also turn on 'Toe switch' function to turn on/off the Wah module while you are pressing the EXP pedal.
7	Low Fc	Low frequency cut.
8	High Fc	High frequency cut.
9	Curve	Waveform of the position sweep LFO. Trig: Triangular wave. Sine: Sine wave. Step: Stepped PWM style wave. Rand: Random pattern.
10	Attack	Speed of the envelope. 100 is the fastest.
11	Sensitive	Sensitivity of the envelope.
12	Direction	Direction of the band pass filter sweep.
13	Level	Adjusts the volume level of modulation.
14	Depth	Adjusts the depth of modulation.

Note: The names of the manufacturers and products mentioned in this manual are the property of their respective companies and are used here only to illustrate the types of effect sounds simulated in this product.

Overdrive modules

Effect Description		
No.	Model name	Description
1	Pure Boost	Based on MOOER® Pure Boost
2	Flex Boost	Based on MOOER® Flex Boost
3	Tube DR	Based on B.K. Butler® Tubedrive
4	808	Based on IBANEZ® TS808
5	OD250	Based on DOD® OD250
6	D-Drive	Based on Barber® Direct Drive
7	Black Rat	Based on ProCo® Rat
8	Grey Faze	Based on MOOER® Grey Faze
9	Muffy	Based on EHX® Big Muff
10	Fuzz Department	Based on ZVEX® Fuzz Factory
11	MTL Zone	Based on BOSS® Metal Zone
12	MTL Master	Based on Digitech® Metal Master
13	Obsessive Dist	Based on Fulltone® OCD
14	Jimmy OD	Based on Paul Cochrane® Timmy OD
15	Full Dr	Based on Fulltone® Fulldrive 2
16	Shred	Based on Marshall® Shred Master
17	Beebee Pre	Based on Xotic® BB Preamp
18	Beebee+	Based on Xotic® BB Plus
19	Riet	Based on Suhr® Riot
20	Tight DS	Based on Amptweaker® Tight Rock
21	Full DS	Based on Fulltone® GT-500
22	Gold Clon	Based on Klon® Centaur Gold
23	VX Tube OD	Based on VOX® Tube OD
24	Tight Metal	Based on Amptweaker® Tight Metal
25	The Juicer	Based on MOOER® The Juicer
26	Rumble Drive	Based on MOOER® Rumble Drive
27	Solo	Based on MOOER® Solo
28	Blues Mood	Based on MOOER® Blues Mood
29	Blues Crab	Based on MOOER® Blues Crab
30	Blade	Based on MOOER® Blade
31	Hustle Drive	Based on MOOER® Hustle Drive
32	ROD 881	Based on MAXON® ROD-881 Drive
33	RED AT	Based on JHS® The AT Drive
34	ODR1	Based on NOBELS® ODR-1 Drive
35	BE OD	Based on FRIEDMAN® BE-OD Distortion

Parameter Description		
No.	Parameter	Description
1	Gain	Adjusts the input gain and drive level.
2	Tone	Adjusts the tone color.
3	Vol	Adjusts the output volume level.

Note: The names of the manufacturers and products mentioned in this manual are the property of their

respective companies and are used here only to illustrate the types of effect sounds simulated in this product.

Amplifier modules

Effect Description (Classic)		
No.	Model name	Description
1	65 US DLX	Based on Fender® 65 Deluxe Reverb (preamp only)
2	65 US TW	Based on Fender® 65 Twin Reverb (preamp only)
3	59 US BASS	Based on Fender® 59 Bassman (preamp only)
4	US Sonic	Based on Fender® Super Sonic (preamp only)
5	US BLUES CL	Based on Fender® Blues Deluxe Clean Setting (preamp only)
6	US BLUES OD	Based on Fender® Blues Deluxe Overdrive Setting (preamp only)
7	E650 CL	Based on ENGL® E650 Clean Setting (preamp only)
8	Powerbell CL	Based on ENGL® Powerball E645 Clean Setting (preamp only)
9	Blacknight CL	Based on ENGL® Blackmore Signature Clean Setting (preamp only)
10	MARK III CL	Based on MESA Boogie® MARK III Clean Setting (preamp only)
11	MARK V CL	Based on MESA Boogie® MARK V Clean Setting (preamp only)
12	Tri Rec CL	Based on MESA Boogie® Triple Rectifier Clean Setting (preamp only)
13	Rockvrb CL	Based on Orange® Rockverb Clean Setting (preamp only)
14	DR ZEE 18 JR	Based on DR.Z® Maz18 Jr (preamp only)
15	DR ZEE Reck	Based on DR.Z® Z-Wreck (preamp only)
16	JET 100H CL	Based on Jet City® JCA100H Clean Setting (preamp only)
17	JAZZ 120	Based on Roland® JC-120 (preamp only)
18	UK 30 CL	Based on VOX® AC30 Clean Setting (preamp only)
19	UK 30 OD	Based on VOX® AC30 Overdrive Setting (preamp only)
20	HWT 103	Based on Hiwatt® DR-103 (preamp only)
21	PV 5050 CL	Based on Peavey® 5150 Clean Setting (preamp only)
22	Regal Tone CL	Based on Tone King® Falcon Rhythm Setting (preamp only)
23	Regal Tone OD1	Based on Tone King® Falcon Tweed Setting (preamp only)
24	Carol CL	Based on Two Rock® Coral Clean Setting (preamp only)
25	Cardeff	Based on Two Rock® Cardiff (preamp only)
26	EV 5050 CL	Based on EVH® 5150 Clean Setting (preamp only)
27	HT Club CL	Based on Blackstar® HT Stage 100 Clean Setting (preamp only)
28	Hugen CL	Based on Diezel® Hagen Clean Setting (preamp only)
29	Koche OD	Based on Koch® Powertone Overdrive Setting (preamp only)
30	J800	Based on Marshall® JCM800 (preamp only)
31	J900	Based on Marshall® JCM900 (preamp only)
32	PLX 100	Based on Marshall® Plexi 100 (preamp only)
33	E650 DS	Based on Engl® E650 Distortion Setting (preamp only)
34	Powerbell DS	Based on ENGL® Powerball E645 Distortion Setting (preamp only)
35	Blacknight DS	Based on ENGL® Blackmore Signature Distortion Setting (preamp only)
36	MARK III DS	Based on MESA Boogie® MARK III Distortion Setting (preamp only)
37	MARK V DS	Based on MESA Boogie® MARK V Distortion Setting (preamp only)
38	Tri Rec DS	Based on MESA Boogie® Triple Rectifier Distortion Setting (preamp only)
39	Rockvrb DS	Based on Orange® Rockverb Distortion Setting (preamp only)
40	Citrus 30	Based on Orange® AD30 (preamp only)
41	Citrus 50	Based on Orange® OR50 (preamp only)
42	Slow 100 CR	Based on Soldano® SLO-100 Crunch Setting (preamp only)
43	Slow 100 DS	Based on Soldano® SLO-100 Distortion Setting (preamp only)
44	Jet 100H OD	Based on Jet City® JCA100H Overdrive Setting (preamp only)

45	PV 5050 DS	Based on Peavey® 5150 Distortion Setting (preamp only)
46	Regal Tone OD2	Based on Tone King® Falcon Lead Setting (preamp only)
47	Carol OD	Based on Two Rock® Coral Overdrive Setting (preamp only)
48	EV 5050 DS	Based on EVH® 5150 Distortion Setting (preamp only)
49	Ht Club DS	Based on Blackstar® HT Stage 100 Distortion Setting (preamp only)
50	Hugen OD	Based on Diezel® Hagen Overdrive Setting (preamp only)
51	Hugen DS	Based on Diezel® Hagen Distortion Setting (preamp only)
52	Koche DS	Based on Koch® Powertone Distortion Setting (preamp only)

Effect Description (Boutique preamps)		
No.	Model name	Description
1	62 US DX	Based on Fender® Brownface Deluxe (preamp only)
2	55 US TD	Based on Fender® Tweed Deluxe 1955 (preamp only)
3	59 US Bass	Based on Fender® 1959 Bassman (preamp only)
4	UK30 CL	Based on VOX® AC30 Clean Setting (preamp only)
5	UK30 CR	Based on VOX® AC30 Overdrive Setting (preamp only)
6	UK30 DS	Based on VOX® AC30 Distortion Setting (preamp only)
7	Matchbox 30 CL	Based on Matchless® C30 Clean Setting (preamp only)
8	Matchbox 30 OD	Based on Matchless® C30 Crunch Setting (preamp only)
9	Regal Tone SK CL	Based on Tone King® Sky King Clean Setting (preamp only)
10	Regal Tone SK CR	Based on Tone King® Sky King Crunch Setting (preamp only)
11	CAA OD100 CH1	Based on Custom Audio® OD100 Clean Setting (preamp only)
12	CAA OD100 CH2	Based on Custom Audio® OD 100 Crunch Setting (preamp only)
13	CAA OD100 CH3	Based on Custom Audio® OD100 Distortion Setting (preamp only)
14	SPT 100 CL	Based on Suhr® PT100 Clean Setting (preamp only)
15	SPT 100 DS	Based on Suhr® PT100 Distortion Setting (preamp only)
16	Rock Vrb CL	Based on Orange® Rockerverb Clean Setting (preamp only)
17	Rock Vrb DS	Based on Orange® Rockerverb Distortion Setting (preamp only)
18	J800 CL	Based on Marshall® JCM800 Clean Setting (preamp only)
19	J800 CR	Based on Marshall® JCM800 Crunch Setting (preamp only)
20	J800 DS	Based on Marshall® JCM800 Distortion Setting (preamp only)
21	PLX 100 CL	Based on Marshall® PLEXI 100 Clean Setting (preamp only)
22	PLX 100 DS	Based on Marshall® PLEXI 100 Distortion Setting (preamp only)
23	EV 5050 CH1	Based on EVH® 5150 III GREEN Channel (preamp only)
24	EV 5050 CH2	Based on EVH® 5150 III BLUE Channel (preamp only)
25	EV 5050 CH3	Based on EVH® 5150 III RED Channel (preamp only)
26	Cali BLD CL	Based on Mesa Boogie® Rectifier Badlander Clean Setting (preamp only)
27	Cali BLD CR	Based on Mesa Boogie® Rectifier Badlander Crunch Setting (preamp only)
28	Cali BLD DS	Based on Mesa Boogie® Rectifier Badlander Distortion Setting (preamp)

Effect Description (Boutique Amps)		
No.	Model name	Description
1	55 US TD	Based on Fender® Tweed Deluxe 1955 (complete amp)
2	59 US Bass	Based on Fender® 1959 Bassman (complete amp)
3	UK30 CL	Based on VOX® AC30 Clean Setting (complete amp)
4	UK30 CR	Based on VOX® AC30 Crunch Setting (complete amp)
5	UK30 DS	Based on VOX® AC30 Distortion Setting (complete amp)
6	ODS 100 CL	Based on Dumble® ODS Clean Setting (complete amp)
7	ODS 100 CR	Based on Dumble® ODS Crunch Setting (complete amp)
8	ODS 100 DS	Based on Dumble® ODS Distortion Setting (complete amp)

9	Dividers CL	Based on Divided By 13® Clean Setting (complete amp)
10	Dividers DS	Based on Divided By 13® Distortion Setting (complete amp)
11	CAA OD100 CH1	Based on Custom Audio® OD100 Clean Setting (complete amp)
12	CAA OD100 CH2	Based on Custom Audio® OD100 Crunch Setting (complete amp)
13	CAA OD100 CH3	Based on Custom Audio® OD100 Distortion Setting (complete amp)
14	Rock Vrb CL	Based on Orange® Rockerverb Clean Setting (complete amp)
15	Rock Vrb DS	Based on Orange® Rockerverb Distortion Setting (complete amp)
16	J800 CL	Based on Marshall® JCM800 Clean Setting (complete amp)
17	J800 CR	Based on Marshall® JCM800 Crunch Setting (complete amp)
18	J800 DS	Based on Marshall® JCM800 Distortion Setting (complete amp)
19	PLX 100 CL	Based on Marshall® Plexi 100 Clean Setting (complete amp)
20	PLX 100 DS	Based on Marshall® Plexi 100 Distortion Setting (complete amp)
21	EV 5050 CH1	Based on EVH® 5150 III Green Channel (complete amp)
22	EV 5050 CH2	Based on EVH® 5150 III Blue Channel (complete amp)
23	EV 5050 CH3	Based on EVH® 5150 III Red Channel (complete amp)
24	Cali BLD CL	Based on Mesa Boogie® Rectifier Badlander Clean Setting (compl. amp)
25	Cali BLD CR	Based on Mesa Boogie® Rectifier Badlander Crunch Setting (compl. amp)
26	Cali BLD DS	Based on Mesa Boogie® Rectifier Badlander Distortion Setting (cpl. amp)

Effect Description (Bass Preamp)		
No.	Model name	Description
1	Ampog 20D	Based on Ampeg® 20D (preamp)
2	Ampog B18 CL	Based on Ampeg® B18 (preamp)
3	Ampog SVT 4	Based on Ampeg® SVT 4 Pro (preamp)
4	Ampog SVT VALUE	Based on Ampeg® SVT 7 Pro (preamp)
5	Mvrkbass 500	Based on Markbass® R500 (preamp)
6	Mvrkbass 501	Based on Markbass® TA501 (preamp)
7	Akuila 750 CL	Based on Aguilar® DB750 Low Gain Setting (preamp)
8	Akuila 750 DS	Based on Aguilar® DB750 High Gain Setting (preamp)
9	Akuila 751	Based on Aguilar® DB751 Overdrive Setting (preamp)
10	Basser Crunch	Based on Dark Glass® B7K (preamp)

Parameter Description		
No.	Parameter	Description
1	Gain	Adjusts the input gain and drive level.
2	Bass	Adjusts the low frequency level.
3	Mid	Adjusts the middle frequency level.
4	Treble	Adjusts the high frequency level.
5	Brightness	Adjusts the higher frequencies of the AMP block.
6	Master	Final output level of the AMP block.

Note: The names of the manufacturers and products covered in this manual are the property of their respective companies, and are used here only for the purpose of illustrating the types of effect tones simulated in this product.

Poweramp Modules

Effect Description		
No.	Model name	Description
1	Normal EL34	Based on EL34 power tube.
2	Normal EL84	Based on EL84 power tube.
3	Normal 6L6	Based on 6L6 power tube.
4	Normal 6V6	Based on 6V6 power tube.
5	Doctor 3 EL84	Based on Dr.Z® Z-Wreck EL84 power tube.
6	Badger EL34	Based on Suhr® PT100 power tube.
7	UK Gold EL34	Based on Marshall® JVM 410H power tube.
8	Cali 6L6	Based on Mesa Boogie® Triple Rectifier power tube.
9	US DLX 6L6	Based on Fender® Blues Deluxe power tube.
10	JJ EL84	Based on JJ® EL84 power tube.
11	Baby Bomb	Based on Mooer® Baby Bomb.

Parameter Description		
No.	Parameter name	Description
1	Power Amp Input	Adjusts the input level of the power amp.
2	Presence	Adjusts the high frequencies of the power amp (about 8 kHz).
3	Bias	Adjusts the simulated tube bias of the power amp.

Note: The names of the manufacturers and products covered in this manual are the property of their respective companies, and are used here only for the purpose of illustrating the types of effect tones simulated in this product.

Cabinet modules

Effect Description (Classic)		
No.	Model name	Description
1	Regal Tone 110	Based on Tone King® Falcon 110 Cabinet
2	US DLX 112	Based on Fender® 65 Deluxe Reverb 112 Cabinet
3	Sonic 112	Based on Fender® Super Sonic 112 Cabinet
4	Blues 112	Based on Fender® Blues Deluxe 112 Cabinet
5	Mark 112	Based on Mesa Boogie® Mark 112 Cabinet
6	Dr Zee 112	Based on DR.Z® MAZ 112 Cabinet
7	Cardeff 112	Based on Two Rock® 112 Cabinet
8	US TW 212	Based on Fender® 65 Twin Reverb 212 Cabinet
9	Citrus 212	Based on Orange® PPC 212 Cabinet
10	DR ZEE 212	Based on DR.Z® Z-Wreck 212 Cabinet
11	Jazz 212	Based on Roland® JC120 212 Cabinet
12	UK 212	Based on VOX® AC30 212 Cabinet
13	Tow Stones 212	Based on Two Rock® 212 Cabinet
14	US Bass 410	Based on Fender® 59 Bassman 410 Cabinet
15	1960 412	Based on Marshall® 1960A 412 Cabinet
16	Eagle p412	Based on ENGL® Pro XXL 412 Cabinet
17	Eagle s412	Based on ENGL® Vintage XXL 412 Cabinet
18	Rec 412	Based on Mesa Boogie® Rectifier Standard 412 Cabinet
19	Citrus 412	Based on Orange® PPC 412 Cabinet
20	Slow 412	Based on Soldano® Slo 412 Cabinet
21	HWT 412	Based on Hiwatt® AP412 Cabinet
22	PV 5050 412	Based on Peavey® 5150 412 Cabinet

23	EV 5050 412	Based on EVH® 5150 412 Cabinet
24	HT 412	Based on Blackstar® HTV 412 Cabinet
25	Diesel 412	Based on Diezel® Hagen 412 Cabinet

Effect Description (Boutique)		
No.	Model name	Description
1	US DLX 112	Based on Fender® Deluxe 112 Cabinet
2	US TWN 212	Based on Fender® Twin Reverb 212 Cabinet
3	US Bass 410	Based on Fender® Bassman 410 Cabinet
4	UK 212	Based on VOX® Silver Alnico 212 Cabinet
5	Matchbox 30 112	Based on Matchless® C30 112 Cabinet
6	Regal Tone FLN 110	Based on Toneking® Falcon 110 Cabinet
7	Regal Tone SK 112	Based on Toneking® Sky King 112 Cabinet
8	Custom 112	Based on Custom Audio® 112 Cabinet
9	Custom 212	Based on Custom Audio® 212 Cabinet
10	Custom 412	Based on Custom Audio® 412 Cabinet
11	SPT 112	Based on Suhr® PT100 112 Cabinet
12	SPT 212	Based on Suhr® PT100 212 Cabinet
13	SPT 412	Based on Suhr® PT100 412 Cabinet
14	CITRUS 112	Based on Orange® PPC 112 Cabinet
15	CITRUS 212	Based on Orange® PPC 212 Cabinet
16	CITRUS 412	Based on Orange® PPC 412 Cabinet
17	1960 412 A	Based on Marshall® 1960A 4x12 Cabinet
18	1960 412 B	Based on Marshall® 1960TV 412 Cabinet
19	1960 412 C	Based on Marshall® 1960BV 412 Cabinet
20	EV 5050 212	Based on EVH® 5150III 212 Cabinet
21	EV 5050 412	Based on EVH® 5150III 412 Cabinet
22	Cali 412 A	Based on Mesa Boogie® 4x12 Recto® Traditional Slant Cabinet
23	Cali 412 B	Based on Mesa Boogie® 4x12 Recto® Traditional Straight Cabinet
24	Cali 412 C	Based on Mesa Boogie® Road King® 4x12 Straight Cabinet
25	CT-SupBMK112	Based on Supro® Black Magick 1x12 Cabinet (ChopTones active)
26	CT-FendS212	Based on Fender® Super Sonic 2x12 Cabinet (ChopTones active)
27	CT-FendTW212	Based on Fender® Twin Reverb 65 Reissue 2x12 Cabinet (ChopTones active)
28	CT-Fend67212	Based on Fender® 1967 Bassman 2x12 Cabinet (ChopTones active)
29	CT-BritJV212	Based on Marshall® JVM 2x12 Cabinet (ChopTones active)
30	CT-Brit412	Based on Marshall® 1960 4x12 Cabinet (ChopTones active)
31	CT-BritJ412	Based on Marshall® 1982 4x12 Cabinet (ChopTones active)
32	CT-Bogie212	Based on Mesa Boogie® 2x12 Cabinet (ChopTones active)
33	CT-BogieLS212	Based on Mesa Boogie® Lonestar 2x12 Cabinet (ChopTones active)
34	CT-BogOS412	Based on Mesa Boogie® OS 4x12 Cabinet (ChopTones active)
35	CT-Vocs212	Based on VOX® BNX 2x12 Cabinet (ChopTones active)
36	CT-Barb212	Based on Mezzabarba® 2x12 Cabinet (ChopTones active)
37	CT-Fram212	Based on Framus® CB 2x12 Cabinet (ChopTones active)
38	CT-Kox212	Based on Koch® Multitone 2x12 Cabinet (ChopTones active)
39	CT-Mgan212	Based on Morgan® Vertical 2x12 Cabinet (ChopTones active)
40	CT-Edd412	Based on EVH® 5150III 4x12 Cabinet (ChopTones active)
41	CT-Fried412	Based on Friedman® 4x12 Cabinet (ChopTones active)
42	CT-Gas412	Based on Diezel® 4x12 Cabinet (ChopTones active)
43	CT-Hess212	Based on Hesu® Modern 2x12 Cabinet (ChopTones active)
44	CT-Hess412	Based on Hesu® 4x12 Cabinet (ChopTones active)

45	CT-HW412	Based on Hiwatt® 4x12 Cabinet (ChopTones active)
46	CT-HK412	Based on Hughes&Kettner® Triamp 4x12 Cabinet (ChopTones active)
47	CT-OR412	Based on Orange® PPC412 4x12 Cabinet (ChopTones active)
48	CT-PvyIn212	Based on Peavey® Invective 2x12 Cabinet (ChopTones active)
49	CT-Pvy50412	Based on Peavey® 5150 4x12 Cabinet (ChopTones active)
50	CT-Revo412	Based on Revv® 4x12 Cabinet (ChopTones active)
51	CT-River412	Based on Rivera® 4x12 Cabinet (ChopTones active)
52	CT-Sold412	Based on Soldano® 4x12 Cabinet (ChopTones active)
53	CT-VTH412	Based on VHT® 4x12 Cabinet (ChopTones active)
54	CT-Win412	Based on Victory® 4x12 Cabinet (ChopTones active)

Effect Description (Bass Cabinets)		
No.	Model name	Description
1	SV810 U47	Based on Ampeg® SVT-810E Cabinet (Mic: Neumann® U47)
2	SV810 7B	Based on Ampeg® SVT-810E Cabinet (Mic: Shure® SM7B)
3	SV810 121	Based on Ampeg® SVT-810E Cabinet (Mic: Royer® R-121)
4	HK U47	Based on Hartke® 45XL Cabinet (Mic: Neumann® U47)
5	HK 7B	Based on Hartke® 45XL Cabinet (Mic: Shure® SM7B)
6	HK 121	Based on Hartke® 45XL Cabinet (Mic: Royer® R-121)
7	HK 421	Based on Hartke® 45XL Cabinet (Mic: Sennheiser® MD-421)
8	Akuila U47	Based on Aguilar® DB115 Cabinet (Mic: Neumann® U47)
9	Akuila 7B	Based on Aguilar® DB115 Cabinet (Mic: Shure® SM7B)
10	Akuila 121	Based on Aguilar® DB115 Cabinet (Mic: Royer® R-121)

Parameter Description		
No.	Parameter	Description
1	Low Cut	Low frequency cut after the microphones
2	High Cut	High frequency cut after the microphones
3	Early Reflection	Adds a very slight delay for indoor sound and feel. 0 = no reflection.
4	Sample	Adjusts the sample rate
5	Output	Adjust the output volume level of the module.

Note: The names of the manufacturers and products covered in this manual are the property of their respective companies, and are used here only for the purpose of illustrating the types of effect tones simulated in this product.

Equalizer modules

Effect Description		
No.	Model name	Description
1	3 Bands EQ	Simple amp style 3-band EQ.
2	5 Bands EQ	Simple amp style 5-band EQ.
3	MOOER HM	Stompbox style 5-band EQ for heavy guitar.
4	MOOER B	Stompbox style 6-band EQ for guitar.
5	MOOER G6	Stompbox style 6-band EQ for guitar.
6	MOOER G10	Stompbox style 10-band EQ for guitar.
7	Custom EQ	Stompbox style 3-band EQ with adjustable frequency bands.
8	STUDIO EQ Pro	Fully customizable parametric EQ.
9	AI EQ Master	AI EQ module with advanced artificial intelligence program.

Parameter Description		
-----------------------	--	--

No.	Parameter	Description
1	100Hz	Adjusts the gain level at 100 Hz.
2	630Hz	Adjusts the gain level at 630 Hz.
3	1.6kHz	Adjusts the gain level at 1600 Hz.
4	4kHz	Adjusts the gain level at 4000 Hz.
5	Output	Adjusts the output level.
6	Low Gain	Adjusts the gain level of the low frequencies.
7	Low Freq	Specifies the center of the custom low frequency range that will be adjusted by the Low Gain.
8	Mid Gain	Adjusts the gain level of the mid frequencies
9	Mid Freq	Specifies the center of the custom middle frequency range that will be adjusted by the Mid Gain.
10	High Gain	Adjusts the gain level of the high frequencies.
11	High Freq	Specifies the center of the custom high frequency range that will be adjusted by the High Gain.
12	Low	Adjusts the gain level of the low frequencies.
13	Mid	Adjusts the gain level of the mid frequencies.
14	High	Adjusts the gain level of the high frequencies.
15	Output	Adjusts the output level.
16	Band 1 Gain	Adjusts the Band 1 gain level.
17	Band 1 Freq	Adjusts the center of the Band 1 frequency range that will be adjusted by the Band 1 Gain.
18	Band 1 Q	Adjusts the width of the area affected by the EQ centered at the freq. Higher values will narrow the area.
19	Band 2 Gain	Adjusts the Band 2 gain level.
20	Band 2 Freq	Adjusts the center of the Band 2 frequency range that will be adjusted by the Band 2 Gain.
21	Band 2 Q	Adjusts the width of the area affected by the EQ centered at the freq. Higher values will narrow the area.
22	Band 3 Gain	Adjusts the Band 3 gain level.
23	Band 3 Freq	Adjusts the center of the Band 3 frequency range that will be adjusted by the Band 3 Gain.
24	Band 3 Q	Adjusts the width of the area affected by the EQ centered at the freq. Higher values will narrow the area.
25	Band 4 Gain	Adjusts the Band 4 gain level.
26	Band 4 Freq	Adjusts the center of the Band 4 frequency range that will be adjusted by the Band 4 Gain.
27	Band 4 Q	Adjusts the width of the area affected by the EQ centered at the freq. Higher values will narrow the area.
28	Low Cut	Sets the frequency at which the low cut filter begins to take effect.
29	High Cut	Sets the frequency at which the high cut filter begins to take effect.
30	Type	Choose the type of your music (Clean/Drive/Distortion).
31	Genre	Choose the genre of your music (Pop/Jazz/Rock/Blues/Funk/Metal)
32	Slot	The slot for storing the preset in the GE1000.

FX Loop module

Effect Description		
No.	Model name	Description
1	Fx Loop	Module that can be used to integrate your favorite external effects and preamps into the signal chain, or to integrate the GE1000 into creative and complex setups.
2	Fx Send	The normal Fx Loop module with only the "Send" function, you can use it to send the internal signal to an external device.
3	Fx Return	The normal Fx Loop module with only the "Return" function, you can use it to insert the signal from an external device into the internal effect chain.

Parameter Description		
No.	Parameter	Description
1	Type	Choose between Send or Return.
2	Mode	Choose between serial effects loop and parallel effects loop.
3	Dry/Wet	Progressively adjusts the wet/dry mix when in parallel mode. 100% Wet will send 100% of the signal through the FX LOOP just like Serial mode. 100% Dry will bypass the FX LOOP completely.
4	Send Level	Adjusts the volume level from the effects loop send output.
5	Return Level	Adjusts the recovery level at the effects loop return inputs.

Modulation modules

Effect Description		
No.	Model name	Description
1	Phaser	Based on the MOOER® Ninety Orange.
2	Step Phaser	Square wave phase shifter.
3	Fat Phaser	Low frequency phase shifter.
4	6 Stage Analog Phaser	Six stages phase shifter.
5	12 Stage Analog Phaser	Twelve stages phase shifter.
6	Dual Phaser	Dual channel phase shifter.
7	Modern Phaser	Modern sound phase shifter.
8	Flanger	Based on the MOOER® E-Lady.
9	Jet Flanger	Based on the MOOER® Jet Flanger.
10	Flanger Pro	Professional flanger effect with more parameter controls.
11	Triple Flanger	Rich multi-stage flanger.
12	Modern Flanger	Modern sound flanger.
13	Tremolo	Based on the MOOER® Trelicopter.
14	Optical Tremolo	Simulates a device that reads a pattern printed on a rotating disc and converts it into a volume-modulating "tremolo" sound.
15	60s Tremolo	Pure vintage 60s sound tremolo.
16	Stutter	Choppy cut off filter.
17	Panner	Pans through the left and right phase shift to achieve a different stereo effect.
18	Vibrato	Pitch modulation.
19	Rotary	Simulates a vintage Leslie rotary speaker.
20	Modern Rotary	Modern sound rotary.
21	Ana Chorus	Stompbox style analog chorus.
22	70s Chorus	70s style sound analog chorus.
23	Tri Chorus	Rich multi-stage chorus.

24	Detune	Fine-tuned pitch adjustment.
25	Octave	Adds a note one octave lower or higher.
26	Ring	Ring modulator.
27	Lofi	Low sampling rate filter.
28	Poly Shift	Poly pitch shifter.
29	Slow Gear	Auto volume swell.
30	Harmony	Create different notes based on the dry sound.

Parameter Description		
No.	Model name	Description
1	Rate	Adjusts the speed of modulation.
2	Level	Adjusts the level of modulation.
3	Depth	Adjusts the depth of modulation.
4	Tone	Adjusts the tone of modulation.
5	Mix	Sets the proportion between the original signal (dry) and the effect signal (wet). 0 is 100% dry, 100 is 100% wet.
6	Feedback	Adjusts the volume that is returned to the input. Higher settings will result in more delay repeats.
7	Pitch	Sets the pitch shift value. (Detune : -100 cents to 100 cents; Poly Shift: -1 oct to +1 oct)
8	Sample	Adjusts the sample rate of the Lofi effect.
9	Bit	Adjusts the bit rate of the Lofi effect.
10	Rise	Adjusts the time needed for the volume to reach its maximum. 100 is the slowest.
11	Sweep	Moves the frequency response pattern through a six-octave or twelve-octave range.
12	Resonance	Changes the amplitude and sharpness of the frequency response peaks.
13	Delay	Sets the delay time for the flanger.
14	Manual	Adjusts the depth of modulation.
15	Width	Adjusts the LFO width of the flanger.
16	Speed	Adjusts the speed of modulation.
17	Intensity	Sets the Modulation amount.
18	Duty	Adjusts the ratio of the left panning duration to the whole panning period. 0 = shortest duration, 50 = left duration : right duration = 1:1, 100 = longest duration.
19	Sub	Adjusts the volume of the lower octave of the Octave effect.
20	Sub Tone	Adjusts the tone of the lower octave of the Octave effect.
21	Upper	Adjusts the volume of the upper octave of the Octave effect.
22	Upper Tone	Adjusts the tone of the upper octave of the Octave effect.
23	Dry	Adjusts the volume of the dry signal.
24	Key	Harmony key selection.
25	Shift	Harmony pitch selection.

Time delay modules

Effect Description		
No.	Model name	Description
1	Digital	Recreates the crystal-clear repeats of the 80's delay units.
2	Analog	Modeled after classic stompbox delays with BB chips.
3	Real Echo	Realistic and natural echoes.
4	Tape	Recreates swirly 70's tape echo.
5	Mod	Digital Delay with modulated repeats.
6	Reverse	Clear reverse delay.
7	Dynamic	Digital Delay which responds to instrument dynamics.
8	Pingpong	Normal Ping Pong sound stereo delay.
9	Crystal	Delay with shimmer harmonization and modulation sound mixed in.
10	Rainbow	Special effect pitch Delay with modulation.
11	Sweep	Delay with a modulated envelope reverb.
12	Dual Delay	2 clear delays with independent controls.
13	Multi Tap Delay	3 clear delays with independent controls.
14	Vintage Delay	Delay with low-bit effect mixed in.
15	Galaxy Delay	Delay with swelled repeats and a light modulation.
16	Fuzz Delay	Delay with classic stompbox Fuzz mixed in.

Parameter Description		
No.	Parameter	Description
1	Level	Sets the independent delay level with independent level parameter.
2	Feedback	Adjusts the number of delay repeats.
3	Time	Adjusts the delay repeat time in Milliseconds / Sets the delay repeat time in relation to the preset tempo (Tempo Sync On).
4	Depth	Adjusts the modulation width of the delay repeats.
5	Rate	Adjusts the modulation speed of the delay repeats.
6	Tempo Sync (off/on)	Activates preset tempo synchronization and sub-division parameter.
7	Trail (off/on)	Activates the trail function for some effects.
8	Mod Rate	Adjusts the modulation width of the delay repeats.
9	Mode Depth	Adjusts the depth of the delay repeats.
10	High Cut	Sets a high frequency EQ shelf for the delay repeats.
11	Low Cut	Sets a low frequency EQ shelf for the delay repeats.
12	Threshold	Sets the envelope detection level of the dynamic delay.
13	Mod Output	Adjusts the output level of the modulation.
14	Filter (lp/bp/hp)	Choose the type of the filter envelopes. (lp: low pass / bp: band pass / hp: high pass).
15	Range	Range of the sweep.
16	Pan	Pans the delay effect left (L), right (R) or centre.
17	Bit	Adjusts the sampling accuracy of the delay repeats.
18	S-Rate	Adjusts the sampling rate of the delay repeats.
19	Attack	Adjusts the speed of the GALAXY sound. 100 is the fastest.
20	Gain	Adjusts amount of distortion of the fuzz.
21	Fuzz Level	Adjusts the mix level of the fuzz.
22	Tone	Adjusts the EQ of the fuzz.
23	Cab	Adds tone compensation to the fuzz for output to full range rigs.
24	Mix	Sets the proportion of mix between the original (dry) and effected (wet) signals. 0 is total dry signal, 100 is total wet signal.

Reverb modules

Effect Description		
No.	Model name	Description
1	Room	Small room reverb
2	Hall	Concert hall reverb
3	Plate	Studio style plate reverb
4	Spring	Classic spring reverb tank
5	Mod	Reverb with modulation effect
6	Filter Reverb	Reverb with static filter effect
7	Fl-Reverb	Reverb with flange effect
8	Reverse Reverb	Backwards Reverb
9	Swell Reverb	Brings in the reverb gradually behind the dry signal
10	Dist Reverb	Reverb with distortion
11	Shimmer	Simulates reverberation with a distinctively sparkling high-frequency range.

Parameter Description		
No.	Model name	Description
1	Pre (Pre-Delay)	Delay time before the first reflections can be heard.
2	Level	Adjusts the effect level.
3	Decay	Length of the reverb trails.
4	Tone	Adjusts the tone of the reverb.
5	Mix	Mix rate of the dry signal and wet signal. 0 is 100% dry sound. 100 is 100% reverb sound.
6	Low Cut	Low frequency EQ shelf
7	High Cut	High frequency EQ shelf
8	Quality	Choose between standard quality and high quality. High quality uses more CPU%.
9	Spring Length	Simulated size of the springs in the spring tank.
10	Spring Depth	Mix of the spring sound in the reverb trails.
11	Rate	Adjusts modulation speed. 100 is the fastest
12	Depth	Adjusts the modulation width of the reverb trails.
13	Mod Level	Adjusts the modulation mix on the reverb trails.
14	Peak	Adjusts the frequency of the filter peak
15	Q	Filter bandwidth. High Q = narrow bandwidth.
16	Filter Level	Adjusts the volume level of the filter applied to the reverb trails.
17	Feedback	Adjusts the feedback intensity of the flanging.
18	Mod-Delay	Adjusts the feedback frequency of the flanging
19	Attack	Rate of automatic volume swell of the reverb effect. 100 is the fastest.
20	Gain	Adjusts amount of distortion.
21	Dist Level	Adjusts the mix level of the distortion
22	Cab	Adds tone compensation to the distortion for output to full range rigs.
23	Shimmer	Volume level of the shimmer harmonization.
24	Trail (off/on)	Toggles the trail function of some of the effects.