

MOOER

GS1000 / GS1000 Li
Intelligent
Amp Profiling Processor

Owner's Manual

CONTENT

PRECAUTIONS.....	2
FEATURES	2
CONTROLS	3
CONNECTIONS.....	5
TERMINOLOGY	6
CONNECTION DIAGRAM.....	7
QUICK START	7
Start up.....	7
Main user interface	7
Stage View	7
Edit View.....	9
Preset selection	9
Bank Switching	9
Shut down	10
OPERATION.....	10
Preset editing	10
Preset composition.....	10
Adding effects.....	10
DSP resources.....	11
Activating / deactivating effects.....	11
Changing the effect chain type.....	11
Chain types	12
Parameter settings for nodes / inputs / outputs.....	15
Input nodes.....	15
Output nodes.....	15
Split node.....	16
Mix node.....	17
Changing effect positions	17
Removing effects.....	18
Parameter editing.....	18
Changing the effect model/type	19
Preset volume.....	19
BPM tempo.....	20
Saving presets.....	22
AI Equalizer.....	23
CTRL Mode	24
Activating the CTRL mode	24
Assigning CTRL functions.....	25

Stompbox mode	25
<i>Tap mode</i>	25
<i>Single mode</i>	25
<i>Multiple mode</i>	26
<i>A/B Mode</i>	26
SubPatch mode.....	27
1. <i>Mapping a parameter to a SubPatch</i>	27
2. <i>Configuring the effect module switching status for a SubPatch</i>	28
3. <i>Modifying / deleting parameter settings in a SubPatch</i>	29
4. <i>CTRL priority setting</i>	30
5. <i>Renaming and clearing a SubPatch</i> :.....	30
Expression Pedal.....	30
Pedal calibration.....	31
Configuration as master volume pedal	32
Configuration as expression pedal	32
Remove expression mappings.....	33
Volume Pedal Settings.....	34
USING EFFECT LOOPS	35
Connecting external effect pedals.....	35
4-Wire connection method	37
Extended input and output options	39
MNRS PROFILING	40
Full amplifier sampling	41
Speaker cabinet sampling.....	43
TUNER.....	44
<i>Tuner screen</i>	45
<i>Tuning</i>	45
<i>Exit tuning mode</i>	45
GROOVE STATION	46
Open the Groove Station.....	46
Groove Station screen	46
Drum Machine.....	47
Looper.....	47
Looper Auto Record.....	47
Drum synchronization	47
Close the Groove Station.....	48
USB DIGITAL AUDIO.....	49
Parameter descriptions	49
Mode descriptions.....	50

Normal mode.....	50
Re-Amp mode.....	51
BLUETOOTH AUDIO.....	52
MIDI CONFIGURATION.....	52
Supported MIDI commands.....	52
GS1000 as controlled device.....	53
MIDI Channel.....	53
CC Mapping.....	53
PC mapping.....	55
Other settings.....	56
GS1000 as controlling device.....	57
MIDI Channel.....	57
PC mapping.....	57
Other settings.....	58
F4 WIRELESS FOOTSWITCH.....	59
Configuring the wireless footswitch.....	59
Available functions for the wireless footswitch.....	60
OTHER GLOBAL SETTINGS.....	61
Global input settings.....	61
Global output settings.....	61
1. Global output levels.....	62
2. Global equalization adjustment.....	62
3. Other function switches.....	63
Screen Brightness.....	63
Lighting.....	64
Preference section.....	65
BANK SWITCH OVER DISPLAY.....	65
STAGE VIEW.....	65
TAP TEMPO.....	65
BANK SWITCH MODE.....	66
PRIORITY MODE.....	66
VOLUME PEDAL POSITION.....	66
MIDI.....	66
Bluetooth.....	66
F4 Wireless Footswitch.....	66
USB Audio.....	66
Spill-Over (Effect Trails).....	66
Language Selection.....	67
Factory reset.....	68

MOOER STUDIO SOFTWARE & MOOER CLOUD APP.....	69
MOOER STUDIO Software	69
Data Manager interface	69
Firmware update	69
Third party IR import	70
MNRS sampling file management	70
Data backup.....	72
Preset Editor interface.....	72
<i>Preset management</i>	72
<i>Preset editing</i>	72
<i>Effect chain editing</i>	73
<i>Module parameter settings</i>	73
<i>Expression pedal settings</i>	73
<i>Preset volume level and BPM settings</i>	73
<i>Input & output settings</i>	73
<i>Global Settings</i>	74
MOOER CLOUD APP	74
TROUBLESHOOTING	75
SPECIFICATIONS.....	76
ANNEX 1: EFFECT DESCRIPTIONS	78
Dynamic modules	78
Filter modules.....	79
Overdrive modules	80
Amplifier modules	81
Poweramp Modules	84
Cabinet modules.....	84
Equalizer modules	87
FX Loop module.....	88
Modulation modules	88
Time delay modules	90
Reverb modules.....	91

PRECAUTIONS

PLEASE READ CAREFULLY BEFORE PROCEEDING

Power supply

- Please only use a power supply adapter that meets the specifications of the manufacturer.
- Only use power supplies that have been approved by the relevant authorities and that meet local regulation requirements (such as UL, CSA, VDE or CCC).
- Disconnect the power supply when not in use or during thunderstorms.

For GS1000 Li:

- Prevent a device containing a battery from overheating (e.g., keep it out of direct sunlight and away from heat sources, etc.).
- Should the battery leak, prevent the liquid from getting into contact with skin or eyes. In case of contact with the liquid, consult a doctor.
- The battery supplied with this product may pose a risk of fire or chemical burns if not handled properly.

Storage and usage locations

To avoid deformation, discoloration or other serious damage, do not expose this device to any of the following conditions:

- direct sunlight
- extreme temperature or humidity
- excessively dusty or dirty locations
- magnetic fields
- high humidity or moisture
- strong vibrations or shocks

Cleaning

Clean only with a soft, dry cloth. If necessary, lightly moisten the cloth. Do not use abrasive cleaners, cleaning alcohol, paint thinners, wax, solvents, cleaning fluids, or chemical-impregnated wiping cloths.

Operation

- Please do not use excessive force to operate the control elements of the unit.
- Prevent metal, paper or other objects from getting into the unit.
- Please do not drop the unit, and avoid heavy blows.
- Please do not modify the unit without authorization.
- Should repairs be required, please contact the MOOER Customer Service Center for more information.

Connections

Always turn off / disconnect the power to the GS1000 and any other equipment before connecting or disconnecting signal cables. This will help prevent malfunctions and / or damage to other devices. Also make sure to disconnect all connection cables and the power supply before moving the device.

FEATURES

- The first hardware effects unit in the GS series to feature amp and cabinet profiling
- MNRS sampling technology by MOOER allows profiling the sound characteristics of four different device types: distortion/overdrive pedals, preamps, complete amplifiers and speaker cabinets, so you can carry your favorite devices around in your "gear bag"
- Choice between GS1000 (traditional version with power adaptor) and GS1000 Li (version with integrated 7.4 V / 4750 mAh lithium-ion battery for hassle-free operation without external power supply)
- Ambient LED lighting perfectly blends visual and audio experience
- Large 5" high-definition touch screen with intuitive UI, delivering brand-new multi-effect experience
- Features more than 350 original effect modules
- Supports download of MNRS amp simulation sample data into a total of 120 free storage positions (30 x OD, 30 x AMP-Preamp, 30 x Full Amp, 30 x Cabinets)
- Flexible dual-chain effect architecture for more usage scenarios and creative needs
- Supports download of third-party IR cabinet simulation sample files with a sample size of 2048 points, into a total of 50 free storage positions
- Multiple interfaces available to meet the user's requirements in different scenarios, including 1/4" instrument input, XLR microphone input and two balanced 1/4" outputs
- Extensive I/O options provide flexibility for studio, stage and practice applications
- Series / parallel TRS stereo effect loops with adjustable positions in the effect chain can be set up to support your favorite rig configurations
- Supports connection of an external expression pedal to control effect parameters or volume
- Supports connection to the MOOER F4 wireless footswitch for extended control options
- Sub-Patch preset grouping mode allows seamless switching of tone types and parameters while maintaining effect tails
- Supports playback from Bluetooth audio input for practice and accompanied playing
- Groove Station mode with Drum Machine and Looper features which can be synchronized, the perfect tool for creativity and practice
- Precise built-in instrument tuner
- Tap tempo control for tempo-based effects and Drum Machine
- Adjustable Global EQ settings for easy integration in any setup and great results with all different kinds of instruments and venue configurations
- Innovative AI Equalizer provides more inspirations for tone adjustment based on music styles and genres
- Programmable MIDI ports for MIDI IN or MIDI OUT to allow control from external devices or to control other devices
- Type-C USB port:
 - Professional low-latency ASIO USB audio interface (Type-C) supports up to 192 kHz sample rate, providing a one-stop solution for professional musicians
 - USB MIDI function (see [MIDI](#))
 - Supports connection to MOOER Studio software on a computer
 - Firmware updates via PC software
- Dedicated computer software and mobile app available for downloading and sharing presets and samples, sound- editing, backups, firmware updates and cloud access to a vast sound library created by users world wide

CONTROLS

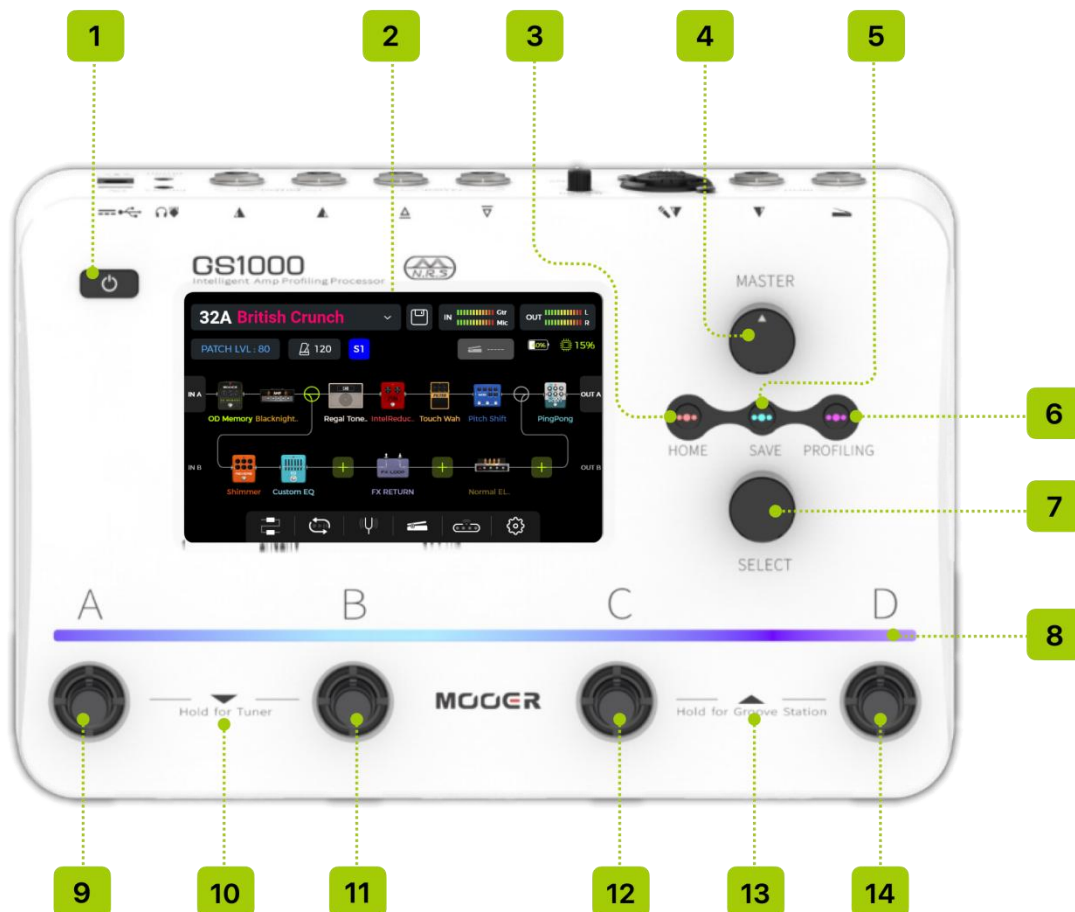

1. **Power switch:** Press to turn the device on and hold it for about 3 seconds to switch it off.
2. **5" Touch screen:** Displays status and information about presets and operating modes.
3. **Home button:** Press to return to the main user interface or to switch between **Stage View** and **Edit View**.
4. **Master knob:** Rotate to adjust the total output volume.
5. **Save button:** Press to save your settings in a Preset.
6. **Profiling button:** Press to enter the MNRS sampling menu (see [PROFILING](#)).
7. **Select knob:** Use to select presets, move modules or edit parameters.
 - Rotate the knob to select items on the screen (highlighted).
 - Press the knob to confirm the selection.
 - Rotate the knob to change values.
 - Press to restore default values.
8. **LED light bar:** Indicates several functional aspects in different situations:
 - Lit above the active footswitch (preset)
 - Blinks to indicate tap tempo
 - Indicates the parameter setting when parameters are adjusted
9. **Footswitch A:**
 - in **Preset mode:** switches to Preset A in the selected bank
 - press again to enter CTRL mode
 - in **CTRL mode:** executes pre-programmed control function (see [CTRL MODE](#)).
 - in **Groove Station** mode: Looper Record / Play / Dub / Undo (see [GROOVE STATION](#)).

10. Footswitches A + B simultaneously:

Press both footswitches to open Bank selection mode and scroll down through the banks (see BANKS).

Hold both footswitches to open Tuner mode (see TUNER).

11. Footswitch B:

- in **Preset Mode**: switches to Preset B in the selected bank
- press again to enter CTRL mode
- in **CTRL mode**: executes pre-programmed control function (see CTRL MODE).
- in **Groove Station** mode: Looper Stop / Delete (see GROOVE STATION).

12. Footswitch C:

- in **Preset mode**: switches to Preset C in the selected bank
- press again to enter CTRL mode
- in **CTRL mode**: executes pre-programmed control function (see CTRL MODE).
- in **Groove Station** mode: Tap Tempo Input for Drum Machine (see GROOVE STATION).

13. Footswitches C + D simultaneously:

Press both footswitches to open Bank selection mode and scroll up through the banks (see Banks).

Hold both footswitches to open Groove Station Mode (see GROOVE STATION).

14. Footswitch D:

- in **Preset mode**: switches to Preset D in the selected bank
- press again to enter CTRL mode
- in **CTRL mode**: executes pre-programmed control function (see CTRL MODE).
- in **Groove Station** mode: Switches Drum Machine on/off (see GROOVE STATION).

CONNECTIONS

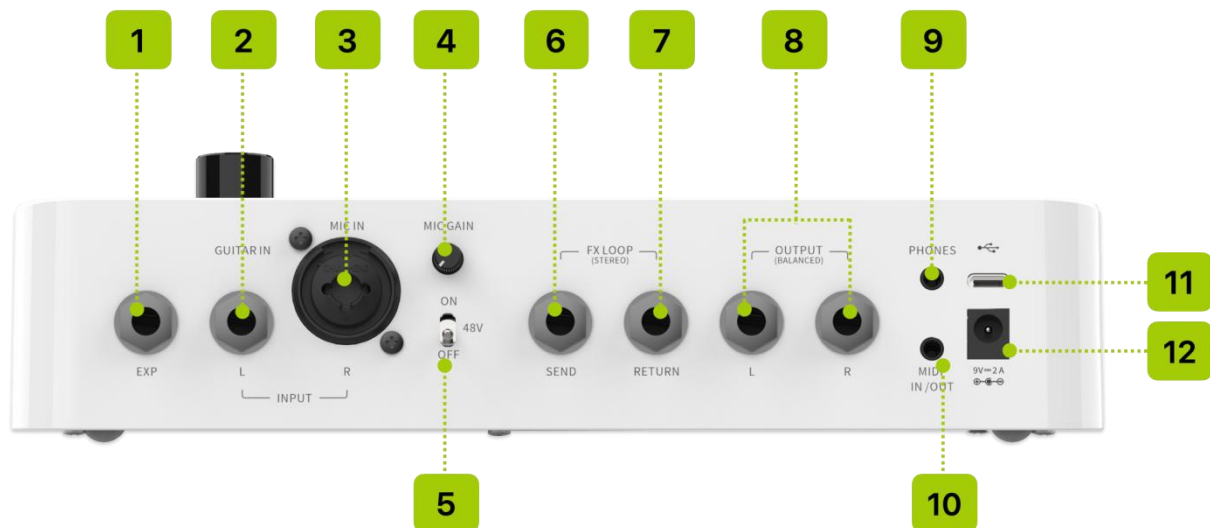

1. **EXP:** 1/4" TRS jack for connecting an external expression pedal (please use a TRS expression pedal with a resistance range of 10 - 100 kΩ - see [Expression Pedal](#)).
2. **GUITAR IN / INPUT L:** 1/4" mono audio jack, input for your guitar or bass instrument. Left input jack for a stereo configuration.
3. **MIC IN / INPUT R:** 1/4" and XLR composite jack. Connect a microphone using an XLR connector or connect an instrument / line signal using a 1/4" connector. Right input jack for a stereo configuration.
4. **MIC GAIN:** Gain adjustment knob for the microphone input.
5. **48 V:** Phantom power toggle switch for microphone input.
6. **FX LOOP SEND:** 1/4" stereo audio jack. Connection to the input of external effects. Connecting an external stereo device requires the use of a TRS to double-ended TS adapter cable (shown below).
7. **FX LOOP RETURN:** 1/4" stereo audio jack. Connection from the output of external effects. Connecting an external stereo device requires the use of a TRS to double-ended TS adapter cable (shown below).



(TRS to double-ended TS adapter cable)

8. **Output connectors (left/right):** 1/4" balanced TRS audio jacks. Connect a 3-conductor (TRS) cable to transmit a balanced signal. Connect a 2-conductor (TS) cable to transmit an unbalanced signal. Connect this jack to the input of an amplifier, another effects unit or any other audio device.
9. **Phones:** 1/8" stereo headphone output jack
10. **MIDI IN/OUT:** 1/8" TRS MIDI connector to connect to an external device that can control the GS1000 or a device that can be controlled by the GS1000.
11. **USB Type C interface:** Connection to a computer for USB audio functions or to use supported software for parameter editing or firmware updates (see [USB Audio](#), see [MOOER Studio](#)).
12. **9 VDC power input:** Connect the supplied power supply adaptor.

TERMINOLOGY

This section explains the terminology used in the manual. Understanding the terminology will help you understand the contents of the manual.

Preset:

- A pre-programmed sound configuration, usually including settings for effects used in the effects chain and their parameters.
- A preset is stored in a storage slot indicated by a bank number (01 - 50) followed by a preset letter (A-D). The 4 presets in each bank can be selected with the A, B, C or D footswitches.

Effects chain:

- The sequence of effects a signal has to pass through within the GS1000 to get from the inputs to the outputs

Effect module:

- The general category of effects models that can be positioned in the effects chain, such as AMP (amp modules), CAB (cabinet simulation modules), REVERB (reverb modules) and so on.

Effect type:

- A specific effect within an effect category, such as "Red Compressor" in category "DYNA".

Effect slot:

- An empty position in the effects chain is shown as a . Click the symbol to load an effect in this position.

Stage View:

- Main interface mode showing information that facilitates stage performance and highlights preset numbers and names to provide for good visibility.

Edit View:

- Main interface mode for sound editing, showing the selected preset, the composition of the effects chain, the status of effect modules in the chain, the preset-based volume level, the current BPM settings and input/output levels. It also shows the battery status for the GS1000 Li and provides access to other settings menus.

Stompbox control mode (CTRL Mode):

- Mode for directly controlling the on/off status of up to four effect modules in the effects chain or the tap tempo for selected parameters using the four footswitches in the lower row. This mode also allows for complex configuration changes with a single step on a footswitch (SUBPATCH switching). The footswitches can each be individually programmed for their specific CTRL function. (See [CTRL Mode](#).)

Groove Station:

- Mode that combines controls for a Drum Machine and Phrase Looper functions. Drum Machine and Looper can also be synchronized in this mode. (See [GROOVE STATION](#).)

MNRS Profiling:

- You can use the **M**ooer **N**on-linear **R**esponse **S**ample technology to capture the sound characteristics of your favorite physical equipment using the **Profiling** function of the GS1000. This supports various capture modes for stompboxes (i.e. distortion / overdrive), preamps, combo amps or speaker cabinets.

Node

- Nodes are points in the effect chain where the signal can be routed into two separate chains or combined from two chains into one (depending on the signal routing structure you have configured).

There are "**split nodes**" which separate signals and "**mix nodes**" which combine signals. Depending on the usage scenario, several parameters can be adjusted for the individual nodes.

CONNECTION DIAGRAM

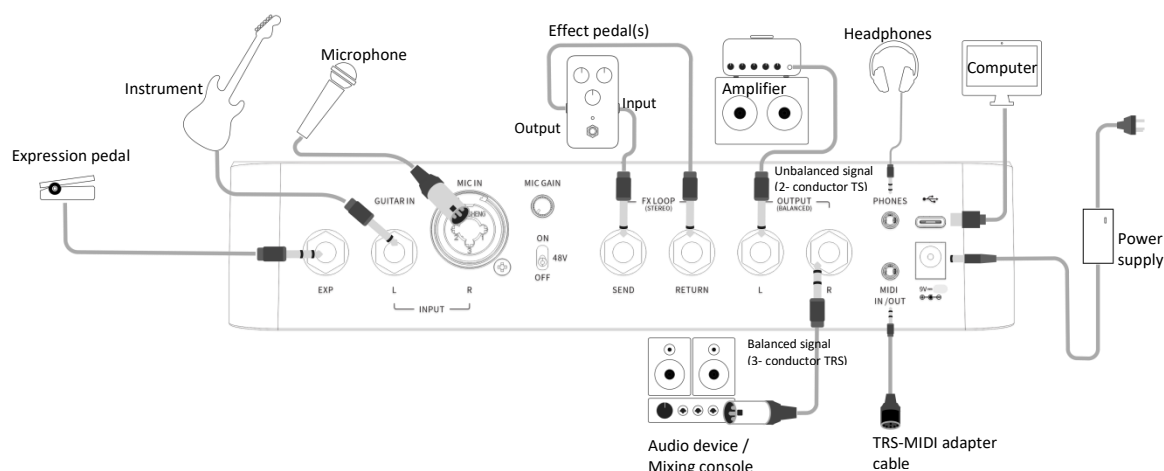

QUICK START

Start up

- Connect the **inputs and outputs** of the device as required according to the connection diagram above.
- Turn the **MASTER volume** knob down to minimize the output volume.
- Connect the included **power supply** (the GS1000 Li can operate on battery power) and turn the device on by pressing the **Power switch**. The display shows a boot-up screen for a few seconds.
- After the boot sequence is completed and the screen shows the **main user interface**, adjust **MASTER volume** to the appropriate volume.

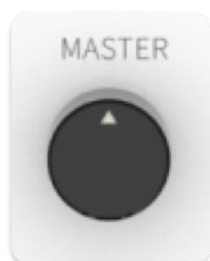

MASTER volume knob

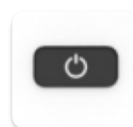

Power switch

Main user interface

The GS1000 comes with two types of main interfaces: the **STAGE VIEW** and the **EDIT VIEW**. You can use the **HOME** button to switch between the two views.

Stage View

This interface highlights number and name of the selected preset, making it easy for players to keep track of the currently selected sound during live performances.

We have designed two different versions of the STAGE VIEW: the "**Detail**" mode, showing number and name of the selected preset as well as a graphic representation of the effects chain, and the "**Large**" mode, showing only the number and the name of the preset for better visibility on stage. You can select your preferred view under "Settings - Preference". (See [Stage View display](#))

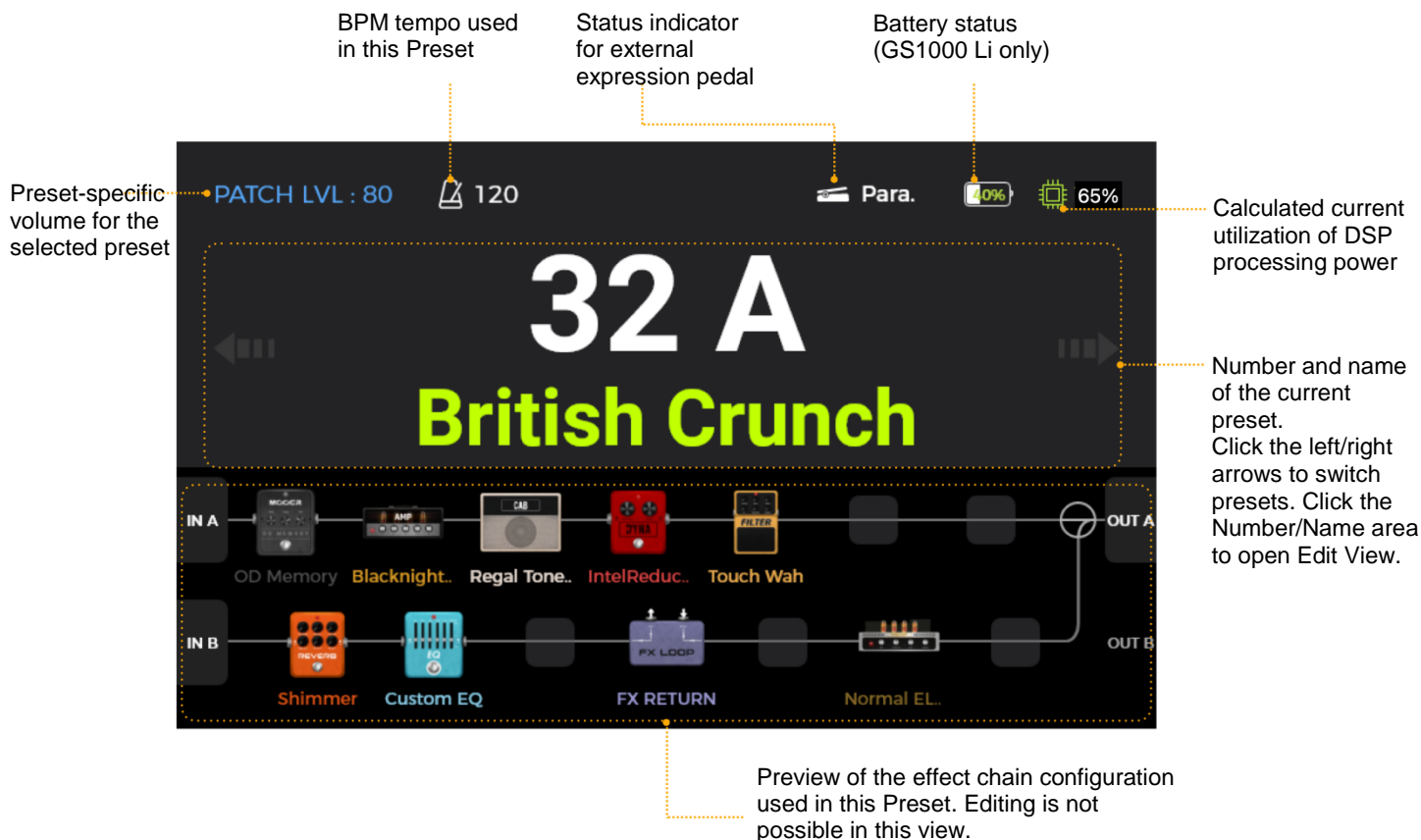

Stage View: Detail mode



Stage View: Large mode

Touch the left/right arrows in the screen or rotate the SELECT knob to switch presets in this screen. After start-up, the device defaults to display the Stage View. Touch the screen or press the **SELECT knob or the HOME button** to enter the main editing interface (Edit View)

Edit View

Almost all control functions of the GS1000 are concentrated in the **EDIT VIEW** user interface screen. This is where you access effect parameters for editing, bring up a list of presets, save presets, adjust global inputs and outputs, and open the Groove Station or the Tuner, or access system settings and other features.



Preset selection

A preset is identified by its bank number (01-50), followed by a letter (A-D). The ambient light strip above the **A/B/C/D** footswitches indicates the currently selected preset. There are several ways to select a preset after the pedal has powered up:

1. In **Stage View**: click the left/right arrows on both sides of the screen.
2. In any of the main interfaces (**Stage or Edit view**): rotate the **SELECT** knob to select a preset.
3. In **Edit View**: Click on the **preset name area** in the upper left corner to expand the list and select a preset.
4. Directly switch between the four presets in the current bank using the **A/B/C/D footswitches** when the pedal is in regular operation mode (The LED strip is lit above one of the four footswitches).

Bank Switching

- Step on **A+B** or **C+D** simultaneously to open the bank selection screen. The screen shows two banks with four presets each. The blinking bottom row indicates the currently selected bank.
- Switch to the **previous** bank by stepping on the **A+B** footswitches simultaneously.
- Switch to the **next** bank by stepping on the **C+D** footswitches simultaneously.
- You can also rotate the **SELECT** knob to select a bank.
- Hold **A+B** or **C+D** down for accelerated browsing through the banks.
- Press one of the **A/B/C/D footswitches** to select a preset from the selected bank and switch back to the main screen.

Shut down

Press the **Power** button for about 3 seconds until the message "Are you sure to Shut Down?" appears on the screen. Confirm the shutdown (YES) or cancel it (NO).

Note for the GS1000 Li: If the power cable is still connected after shutdown, the screen will show a dimmed graphic to indicate the battery charging status.

OPERATION

Preset editing

Before you start editing, it is recommended that you open an empty preset (named 'EMPTY') to work with.

Preset composition

A preset in the GS1000 consists of the following components:

- all effect models (modules) positioned in the current effect chain,
- the effect chain sequence,
- the on/off status of each module in the chain,
- the input and output configuration
- the module parameter settings of each module,
- the expression pedal parameter settings,
- the preset volume value (PATCH LEVEL),
- the BPM value (if used by effects within the preset),
- the preset name and
- the color label.

Adding effects

You can add effects to the effect chain in the following way:



Make sure you are in Edit View and **click on an empty effect slot** in the effect chain (shown as a "+").

The screen will show a list of available effects. Select an **effect module** category on the left side of the screen. Then select the specific **effect type** from the list on the right. See [ANNEX1: EFFECT DESCRIPTIONS](#) for a list of available effects.

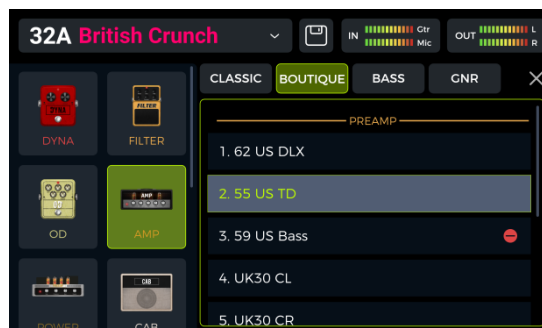

Click the "X" in the upper right corner to close the selection screen and open the parameter editing screen for the selected effect (see [Parameter editing](#)).

Click the "X" in the parameter editing screen to return to the main Edit View.

The display now shows the new module positioned in the effect chain.

Note: The GS1000 effect chain is divided into two lines: A (top line) and B (bottom line). Each line has seven positions for effect modules, for a total of 14 effect modules. The effect chain supports the addition of several instances of the same effect module (with the exception of the FX LOOP module). See section [DSP Resources](#) below.

DSP resources

The number of modules in the chain and the number of times the same module that can be added is limited by the DSP (Digital Signal Processing) resources allocated to each module by the operating system. Depending on their complexity, some modules may require more DSP resources than others. The DSP load only depends on the existence of the module in the chain, not on their on/off status or their parameter settings.

Check the **DSP processing load indication** in the upper right corner of the display. It shows the balance of DSP resources required for the currently selected modules. With increasing percentage of utilized DSP resources, some modules may no longer be available for addition to the effects chain (grayed out in the list) because adding them would exceed the remaining available DSP resources.

The DSP resource indication usually takes a few seconds to update after a module was added or removed from the chain. Avoid using close to 100 % DSP resources or you may experience sound clipping due to transient overload conditions.

Activating / deactivating effects

Note: Active modules are shown as **colored icons** in the effects chain. Deactivated modules are shown as **grey icons** and slightly above the effect chain line.

Option 1: Slide the effect icon on the touch screen slightly up/down to activate/deactivate the module.

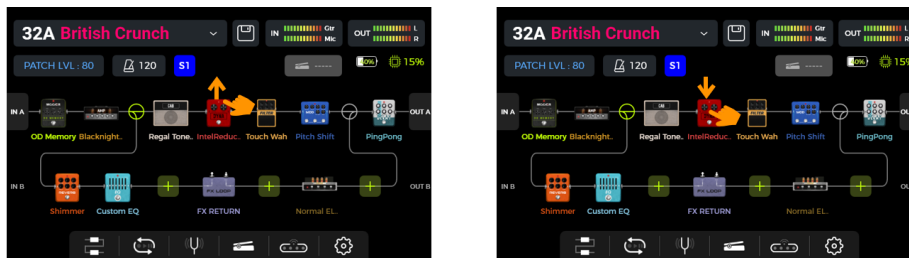

Option 2: Select a module on the touch screen (highlighted by a frame) and **press** the **SELECT** knob to activate / deactivate the module.



For more options to activate/deactivate effect modules while playing, see [CTRL Mode](#) or [MIDI](#).

Changing the effect chain type

For more diversity and usage options, the dual effect chain of the GS1000 supports a variety of routing structures by establishing signal routing nodes. You can click on the **Effect Chain Type** icon at the bottom of the main editing interface for a quick setup:

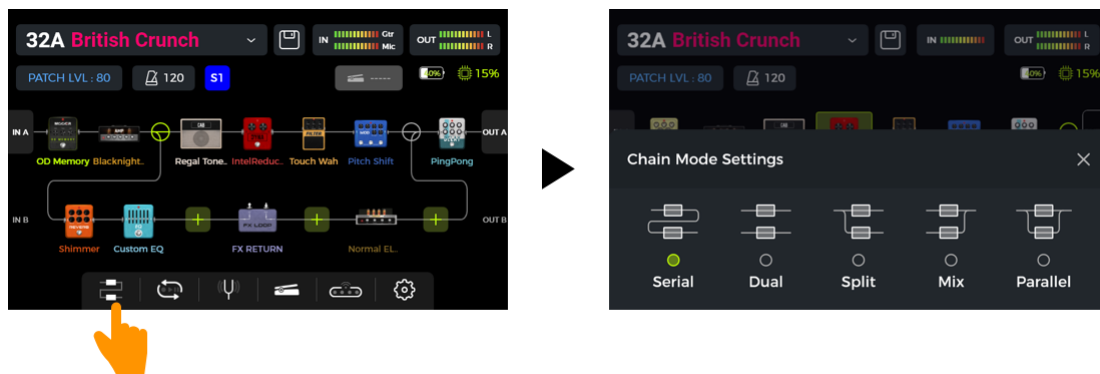

A set of routing templates is opened to allow you to quickly select the type of effect chain that is closest to your needs. Select one and close the selection screen with the X in the upper right corner. The effect chain will now show **nodes** according to the template you have selected. You can then move the node positions in the chain by **dragging** them in the touch screen.

The following diagrams illustrate the positions of **split nodes**  and **mix nodes**  and how they can be moved in the effect chain A (top line):

 Locations where split nodes can be moved:

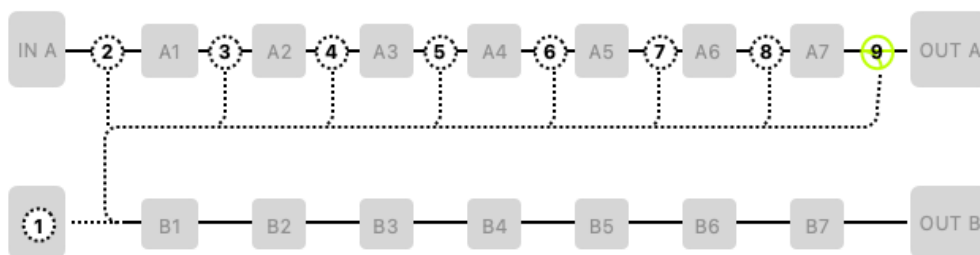

 Locations where the mix node can be moved:

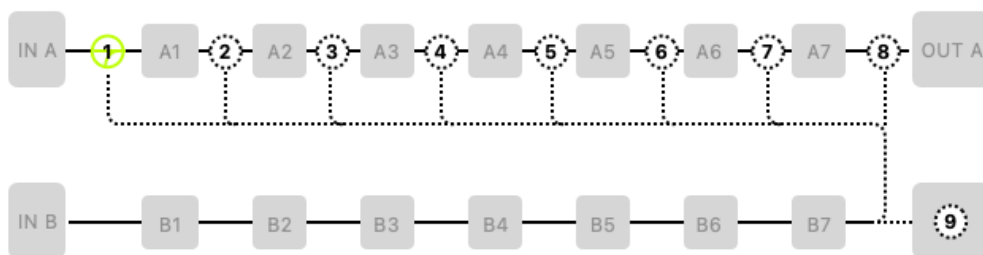

The following rules apply when both split nodes and mix nodes are used in the effect chain:

1. The mix node cannot be set before the split node.
2. Two nodes cannot be set in the same position. For example, two nodes cannot be positioned between A6 and A7 at the same time.
3. Split node and input B (IN B) can be converted into each other. Similarly, mix node and output B (OUT B) can also be converted into each other. This is accomplished by dragging the split node onto the INB Symbol (or vice versa) or by dragging the mix node onto OUTB (or vice versa).

This means in practical application, that you can manually create the five effect chain patterns suggested as templates in the effect chain mode setting screen: Serial, Dual, Split, Mix and Parallel.

Chain types

Serial mode: The most conventional form of effect chain, suitable for most needs and without complex separation, mixing or parallel processing. Players who are new to effect chains should start from this type.

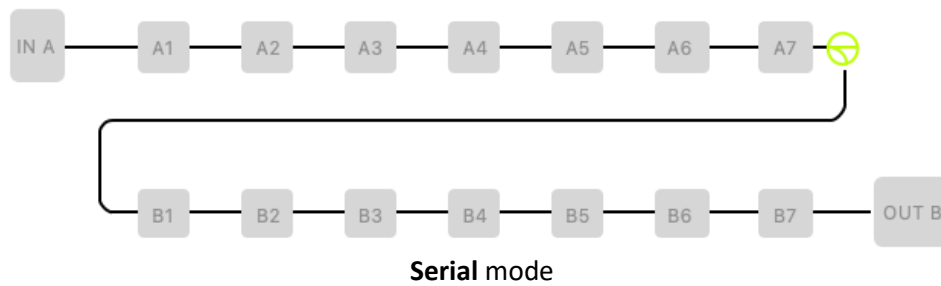

Dual chain mode: Two completely independent effect chains, with separate input and output interface settings. This is often applied with two sets of instruments or connections to independent effect processing equipment. Example: the guitar input runs through effect chain and the microphone input runs through another effect chain.

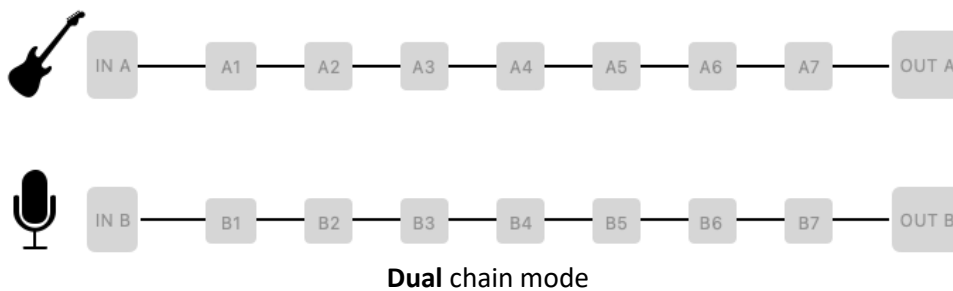

Split mode: After passing some effects or directly after the input, the incoming signal is split and routed to different effects and outputs. This can be used in mixed full-range / non-full-range output scenarios, for instance, where the built-in cabinet simulation is applied to the signal for the full-range platform, and the cabinet simulation is not applied to the signal going to an instrument amp with speakers.

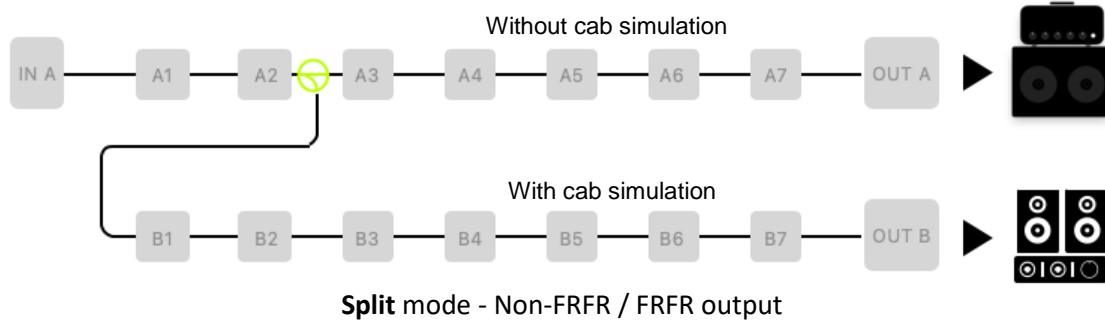

If the split node is configured as **A/B switcher** and one of the footswitches is configured for A/B switching in CTRL mode (see [CTRL Mode](#)), the setup can be used to switch between two different chains as shown below:

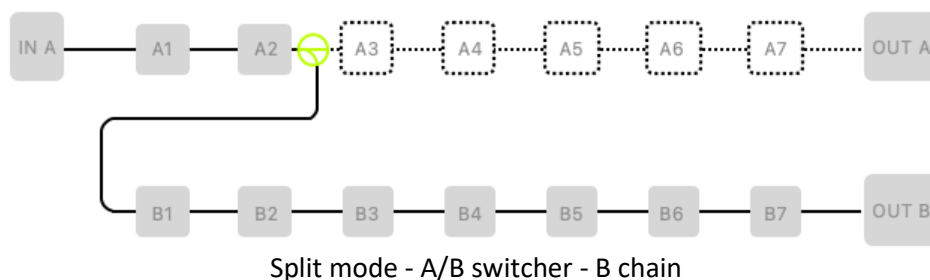

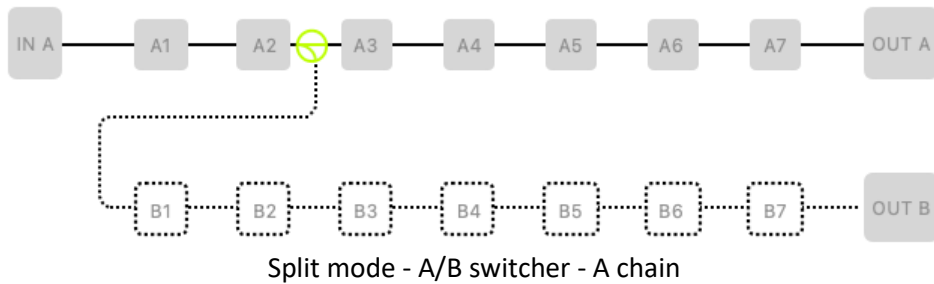

Mix Mode: This mode can be used to combine partially independent effect chains into one chain, which is then routed to common effects and the same output.

Example: Guitar and vocal signals are processed through their own independent preamp and equalization, and then mixed and have the same spatial effects applied to ensure the consistency of the spatial sense. As shown below, guitar effects can be loaded into positions A1 to A5, the microphone effects can be loaded into B1 to B7, and both signals then run through the same spatial effects in positions A6 and A7 for uniform touch-ups.

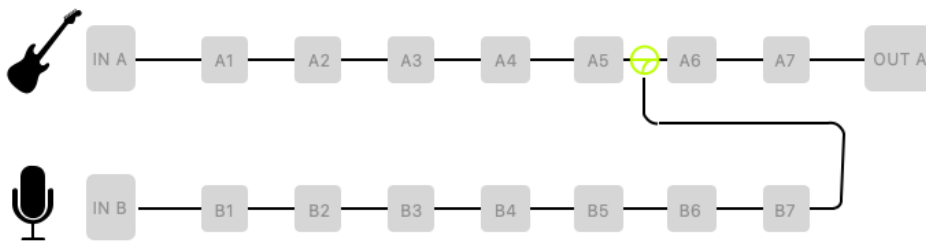

Parallel Mode: This mode is suitable for the scenarios with parallel mixes in the effect chain.

If, for example, chains A and B are loaded with two sets of different types of master tones for mixing, resulting in a unique tone that combines the qualities of both. As shown in the figure below, you can load a set of modules for amplifiers and cabinets in slots A3 to A5, and load another set of modules at any position in the B chain. Then match the volume ratio of the A and B chains in the mixing node to create a unique custom sound.

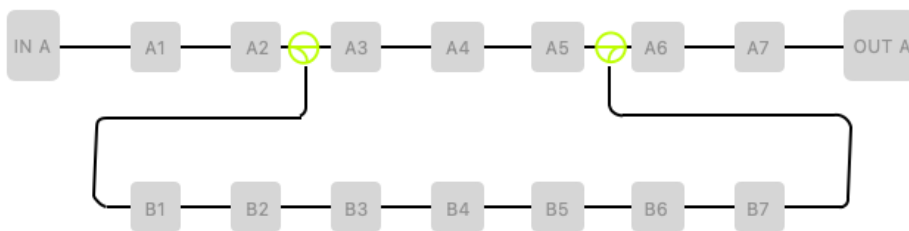

The examples above are just some of many possible effect chain applications. Don't feel limited by dogmas - let your imagination run free and create your own ways of doing things.

Parameter settings for nodes / inputs / outputs

As described above, nodes can be dragged to move them in the effect chain and create different configurations. **In-line nodes**, as well as the **input** and **output nodes**, are also designed with corresponding parameters that can be adjusted to meet different needs.

Double-click an input, output or node on the touch screen to open the corresponding settings screen.

Input nodes

Adjustable parameters for Input A and Input B:

Parameter	Description	Possible selections	Note
Source	Selects the input interface for the selected input node.	Guitar input (left) Microphone input (right) Input left/right Return left Return right Return left/right	See following notes for details.
Level	Sets the output level at the selected node.	0 - 100	Default is 100, below 100 is attenuation.

Guitar input (left): The input source is set to the guitar input connector.

Microphone input (right): The input source is set to the microphone input connector.

Input L/R: The guitar interface is set to the left channel input and the microphone interface is set to the right channel input.

Return left: The input source is set to the left channel of the FXLOOP Return interface.

Return right: The input source is set to the right channel of the FXLOOP Return interface.

Return left/right: The left and right channels of the input are set to the left and right channels of the FXLOOP Return interface.

Output nodes

Adjustable parameters for Output A and Output B:

Parameter	Description	Possible selections	Note
Output Position	Sets the output interface corresponding to the current output node.	All outputs 1/4" output Headphone output Send output	See following notes for details.
Level	Sets the output level at the selected node.	0 - 100	Default is 100, below 100 is attenuation.
Pan	Sets the balance of the stereo panorama for the selected node.	L100 - Center - R100	Centered for left-right balance, L100 is extreme left and R100 is extreme right.

All Outputs: The signal is routed to all output jacks, including the 1/4" output and the headphone output (not including the Send output).

1/4" output: The signal is only routed to the 1/4" connector.

Headphone output: The signal is only routed to the headphone output.

SEND output: The signal is only routed the SEND connector.

Split node

The split node has several modes to accommodate different scenarios.

In **Normal** mode, the signal is split into two, and routed to two effect chains A (top) and B (bottom) at the same time. The signals are then processed separately. The **Normal** mode has the following parameters:

Parameter	Description	Possible selections	Note
A Level	Volume level for the effect chain A.	0 - 100	Default is 100, below 100 is attenuation.
B Level	Volume level for the effect chain B.	0 - 100	Default is 100, below 100 is attenuation.

The **A/B mode**, which can be configured to switch the signal to chain A (top) or B (bottom) has the following parameters:

Parameter	Parameter description	Possible selections	Note
Switcher	After switching , the signal passes through chain A or B.	A, B	A corresponds to the upper chain and B to the lower chain.

Note: After A/B mode is selected, the currently active signal path is shown as a solid line in the effect chain graphic on the main screen. You can use the CTRL mode to program a footswitch for A/B switching and then execute the switching with this footswitch or an external wireless F4 footswitch (see CTRL Mode).

The **crossover mode** (frequency divide mode) provides two sets of high-cut and low-cut parameters, which can be used to set the specified frequency band intervals for the signals of A and B chains, with the following specific parameters:

Parameter	Description	Possible selections	Note
A Level	Volume level of chain A	0 - 100	Default is 100, below 100 is attenuation.
A Low Cut	Low-cut adjustment for chain A.	20 Hz -20 kHz	Default is off.
A High Cut	High-cut adjustment for chain A.	20 Hz -20 kHz	Default is off.
B Level	Volume level of chain B	0 - 100	Default is 100, below 100 is attenuation.
B Low Cut	Low-cut adjustment for chain B.	20 Hz -20 kHz	Default is off.
B High Cut	High-cut adjustment for chain B.	20 Hz -20 kHz	Default is off.

Mix node

The mix node has the following adjustable Parameters:

Parameter	Description	Possible selections	Note
A Level	Chain A volume level.	0 - 100	Default is 100, below 100 is attenuation.
A Pan	Position of the A chain signal in the stereo panorama.	L100 - Center - R100	Centered for L/R balance, L100 is extreme left, R100 is extreme right.
B Level	Chain B volume level.	0 - 100	Default is 100, below 100 is attenuation.
B Pan	Position of the B chain signal in the stereo panorama.	L100 - Center - R100	Centered for L/R balance, L100 is extreme left, R100 is extreme right.
Master	Output volume after mixing	-30 dB - +6 dB	Default is 0 dB.

Changing effect positions

The sequence of modules the signal has to pass through in the effect chain has an effect on the resulting sound. Changing the relative order of the modules in the effect chain is therefore not only a question of operational convenience, but also important for achieving the desired sound.

Option 1: On the touch screen: use your finger to **drag** the module to the desired position in the chain. Should the desired position already be occupied, the other modules in the chain will automatically shift out of the way to the next available position.



Option 2: Select a module on the touch screen (highlighted by frame) and rotate the **SELECT** knob to move the module.



Removing effects

If you need to remove an effect module from the effect chain of the current preset, **long press** the target module on the touch screen until the **delete symbol (-)** appears in the upper right corner of the module icon. Then click the delete symbol to remove the effect module from the chain.



Touch the blank area above the effect chain on the touch screen to return to the normal state (the deletion icon disappears).

Parameter editing

Double click a module icon in the effect chain on the touch screen to open the parameter editing interface. You can adjust the parameters in the following two ways:

Option 1: Touch the desired parameter dial on the touch screen, and use your finger to **slide** the dial to the desired value.



Option 2: Touch the desired parameter dial on the touch screen (parameter name is highlighted in green), and rotate the **SELECT** knob to fine-tune the desired value. You can also press the **SELECT** knob to return the parameter to its **default value**.



Should the effect have more parameters than fit on one screen page, click the **page number** below the parameter dials to access the next page.



Click the "X" in the parameter editing screen to return to the main Edit View.

See [ANNEX 1: EFFECT DESCRIPTIONS](#) for parameter descriptions.

See [Spill-Over \(Effect Trails\)](#) for information about effect trail parameters.

Changing the effect model/type

To change the current effect module to another model or effect type, open the parameter editing screen for the module you want to change (see above) and click the effect icon in the upper left corner. The effect selection screen is opened, from which you can select the desired effect model and the specific type.

Click the "X" in the upper right corner of the selection screen to return to the parameter editing screen. Then click the "X" in the parameter editing screen to return to the main Edit View.

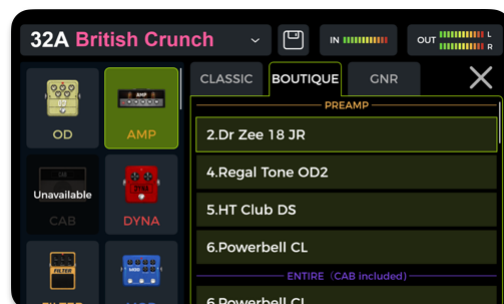

Preset volume

Click the **PATCH LVL** field in the upper left corner of the **Edit View** to adjust the overall output volume of the current preset. This function is convenient for quickly adjusting the volume balance between presets. After the pop-up window for adjusting the **preset volume** appears, change the PATCH LEVEL volume value by sliding the fader up and down with your finger or by rotating the SELECT knob.

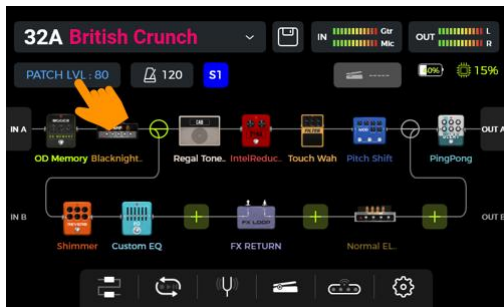

Click on an area outside the pop-up window to return to the Edit View.

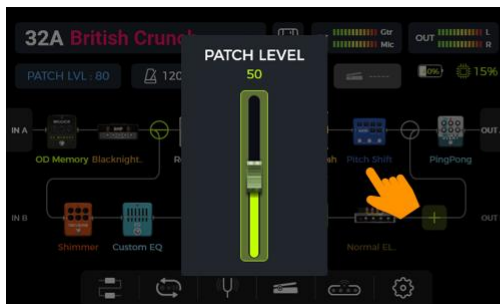

Note: The preset volume only affects the output level of the current preset in comparison to other presets. Use the **MASTER** knob to control the output level of all presets simultaneously.

BPM tempo

Some effects of the GS1000 such as DELAY and MOD modules have a time / rate parameter value that can be controlled by adjusting the BPM (Beats per Minute) value.

Activate the **TEMPO SYNC** parameter for the module to synch the effect tempo with the BPM setting.

Click the **metronome icon** in the Edit View to open the BPM screen.

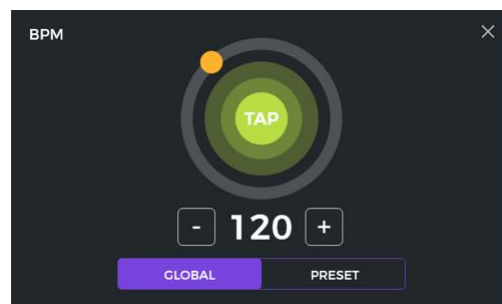
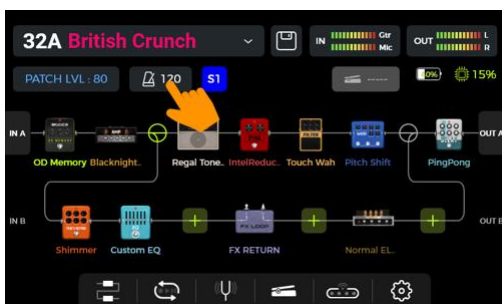

The **GLOBAL** and **PRESET** options in this screen can be used to determine which presets the selected BPM tempo is applied to. **Please make this choice before you change the tempo!**

If **PRESET** is selected, the tempo change is only effective for the **current preset**, and other presets can have different tempos. **You need to save your preset** before switching to another preset.

If **GLOBAL** is selected, the tempo value change is effective for **all presets**, and all other presets will be set to the currently displayed value. **Global BPM changes do not have to be saved and will overwrite all individual BMP settings for other presets.**

You can set the tempo value in several different ways:

Option 1: Adjust the tempo value by sliding the orange dot around the circle.

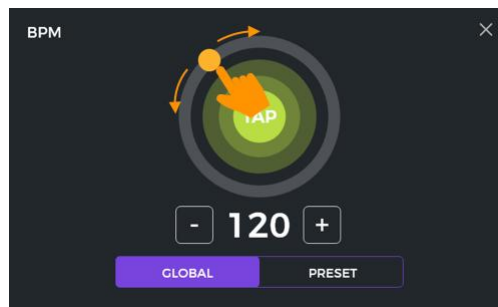

Option 2: Adjust the tempo value by tapping the "TAP" section on the touch screen several times.

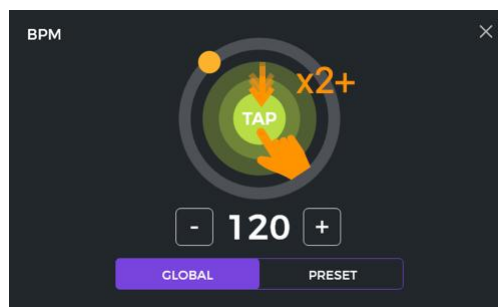

Option 3: Fine-tune with 1 BPM resolution by clicking the '-/+ ' fields.

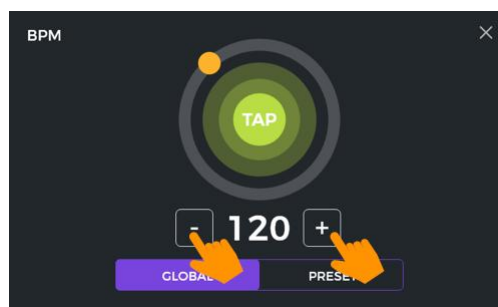

Option 4: Fine-tune with 1 BPM resolution by rotating the SELECT knob while this screen is open.

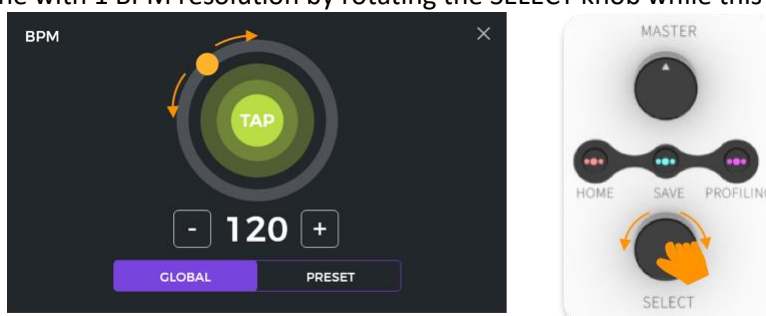

You can use any of these four methods, or a combination of them, to quickly adjust the desired BPM tempo.

Note: The tempo range of the GS1000 is 40 - 260 BPM.

Tap the "X" in the upper right corner to return to the main Edit View.

Saving presets

! Note: If you switch presets (see *Preset Selection*) without saving your settings first, **all changes will be lost** and the preset will return to the previously saved settings the next time you select it.

After adjusting all necessary settings, press the physical **SAVE** button on the panel or click the **Save icon** on the touch screen in Edit View to save your settings.



This will open the Save screen:

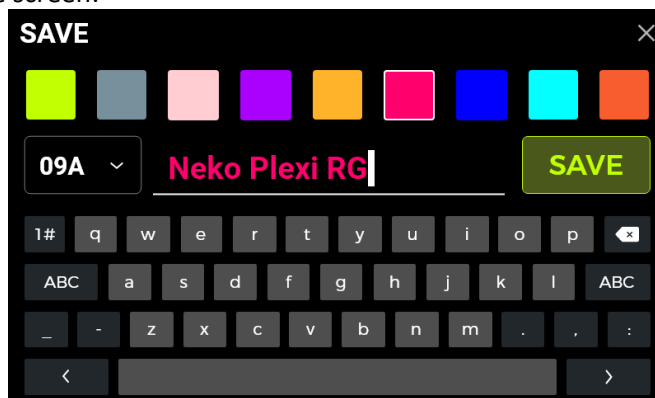

Select a **color** from the top row. The selected color will be applied as follows:

- the color of the **preset name** in the main interface (Edit View and Stage View),
- the color of the **label** and the preset name in the drop-down preset list of the Edit View,
- the color of the **LED bar** above the A/B/C/D footswitches in Stage and Edit mode,
- the color of the large **preset block** in the bank selection screen after A+B or C+D was pressed.

You can set several presets to the same color or to individual colors to quickly find them during stage performances without having to think about this too much while you are playing.

Enter a **preset name** using the on-screen keyboard.

Click the **preset number** to the left of the preset name to open a drop-down menu to select a desired preset slot. The currently used slot is used by default.

! Note: Any already existing settings in a selected preset slot will be overridden by the current settings.

Click **SAVE** or press the **SAVE button** again to confirm the saving process. You will be prompted for another "YES/NO" confirmation on the touch screen.

Cancel: Click the "X" in the upper right corner or press the HOME or SETTING buttons to exit the saving process without saving.

AI Equalizer

The AI EQ MASTER is a self-learning graphic equalizer. The built-in self-learning algorithm can automatically adjust the master tone frequency response curve based on a selected sound type and style of music. This is helpful to quickly achieve an almost ideal baseline for tone adjustments.

To use the feature:

- Add an Equalizer module at the desired position in the effect chain.
- Select "**AI EQ Master**" in the EQ category. (If you are already using a lot of DSP resources, this feature may not be available for selection. Try to reduce the DSP load by removing other modules.)
- Use the drop-down menus to select the **Type** of sound (Clean, Overdrive, Distortion ...) and the **Genre** of music you want to use (Rock, Pop, Blues ...).
- Click the **red button** to start the learning process and play a phrase until the progress bar below the buttons reaches the end and a frequency response curve is generated.

Note: If no curve is generated after the progress bar has reached the end, the AI was unable to extract enough information from your playing to generate the curve. Start the learning progress again and play a greater variety of chords in different positions on the neck to generate a larger sample size for the AI.

- Use the 5-band equalization controls below to **fine-tune** the results to your preference.

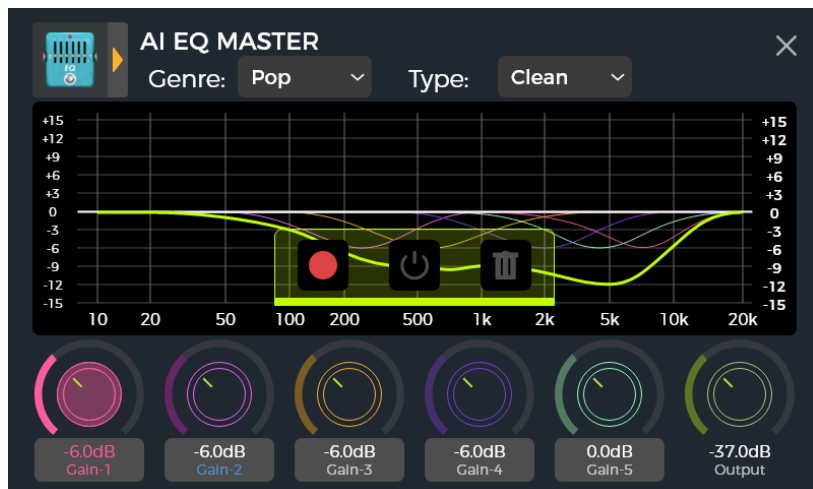

- Click on the areas below the EQ controls to cycle through **Gain, Frequency** and **Q** adjustments.
- Compare the difference in tone before and after processing by clicking the **ON/OFF** button.
- If you are not satisfied, you can click the **trashcan** icon to delete and start a new learning process.

Note: The learning results are **stored with the preset** (don't forget to save before switching presets) and can be used in this preset only. You have to go through the learning process for each preset you want to use the AI EQ Master with.

CTRL Mode

The **CTRL** (control) mode is a footswitch mode based on the currently selected preset.

In CTRL mode, the **B/C/D** footswitches can be used to control modules in the effect chain of the current preset the same way you would control stompboxes on a physical pedal board by using the **ON/OFF footswitches of individual pedals**. Alternatively, one of the footswitches can be configured for **Tap Tempo** input to set the tempo for Delay / Reverb effects. If **A/B switching** is activated for a split node in the effect chain (see [Split Nodes](#)), one of the footswitches can be assigned to perform this A/B switching. In **Stombox** mode, one press of a footswitch can toggle one (Single mode) or several (Multiple mode) modules in the effect chain.

In addition to this, you can use the **SubPatch** mode to program up to three complex switching scenarios like activating/deactivating several modules at the same time and additionally switch one or several parameters to a different value. These three scenarios are called **SubPatches** and can be activated using the **B/C/D** footswitches in CTRL mode.

The configuration of the footswitches only affects the currently selected preset. Each preset can have different CTRL mode footswitch configurations.

Activating the CTRL mode

In Stage View or Edit View, one of the **A, B, C or D** footswitches will have the LED bar above it illuminated to indicate the currently active preset. Step on this footswitch to open the CTRL mode.

The touch screen now displays "**STOMPBOX**" or "**SUBPATCH**" and two fields for each of the three programmable footswitches (**B/C/D**).

Long-press the **A** footswitch or the **A** field to switch between **STOMPBOX** and **SUBPATCH** mode.

In **STOMPBOX** mode, the lower row of **B/C/D** fields is highlighted and the word "**STOMPBOX**" is shown in the upper right corner.

In **SUBPATCH** mode, the upper row of **B/C/D** fields is highlighted and the word "**SUBPATCH**" is shown in the upper right corner.

You can leave the CTRL mode and return to Stage View or Edit View by short-pressing the **A footswitch** or the **HOME** button.

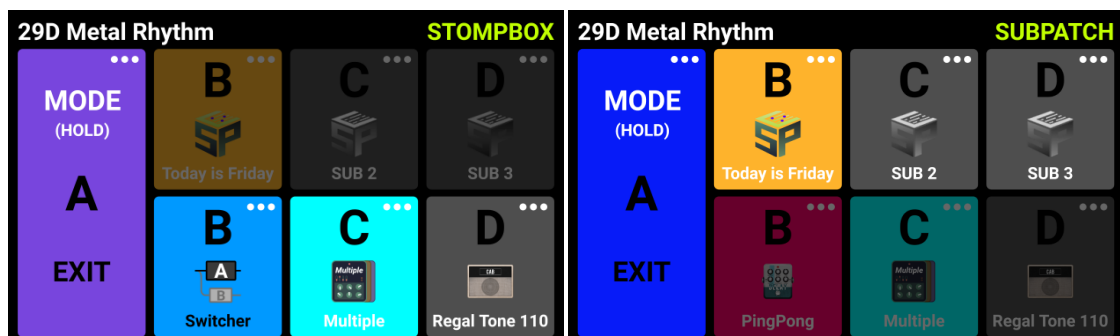

The Footswitch functions correspond to the indication in the respective fields. I.e. in **STOMPBOX** mode, footswitch B will carry out the function indicated in the B field in the lower row and in **SUBPATCH** mode, footswitch B will carry out the function indicated in the B field in the upper row. The fields in the screen and the LED bar above the footswitch indicate which function is currently activated.

A **STOMPBOX** field will show **EMPTY** when no function is assigned yet.

If you step on a footswitch to perform a SUBPATCH function without a SubPatch being assigned, the current preset effect chain configuration will remain unaffected.

Summary:

- Use the **B/C/D** footswitches to execute the assigned functions as indicated in the fields on the screen.
- Use the **A** footswitch to **exit** the CTRL mode (this switch cannot be assigned to a different function).
- Long-press **A** footswitch to switch between the **STOMPBOX** mode and **SUBPATCH** mode.

Assigning CTRL functions

Before configuring CTRL functions, you need to select the sub-mode you want to configure: SUBPATCH mode or STOMPBOX mode. Long-press the A footswitch to toggle between the modes.

After configuration is complete, the B/C/D footswitches can be used to perform the selected functions **for as long as the CTRL mode is active**. (See [F4 WIRELESS FOOTSWITCH](#) for additional options.)

Note: CTRL footswitch assignments must be manually saved into a preset. If you switch presets before you save the current preset, your CTRL assignments for the current preset will be lost. (See [Save presets](#))

Stompbox mode

Click on the "..." symbol in the upper right corner of each footswitch field in the lower row to assign either **tap tempo** (TAP), **effect modules** (STOMPBOX) or **A/B switching** to each footswitch.

Use "**Clear**" to remove an assigned function or "**Rename**" to assign an easily recognizable name (e.g. Chorus, Verse, Bridge ...) to the field (only if STOMPBOX is assigned). This name will only be used in the footswitch field in CTRL mode, not in the Edit View.

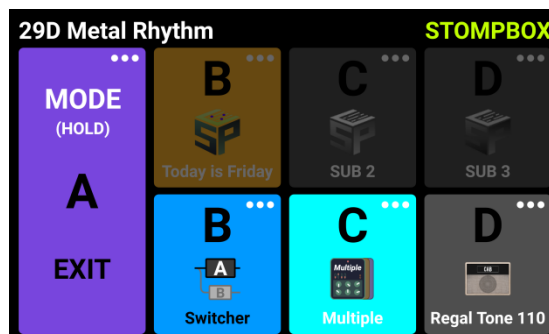

Tap mode

If set to the **TAP** function, this footswitch can be tapped several times to input the desired BPM tempo for effect parameters that are capable of interpreting this value (e.g. Delay effects). The LED bar above this footswitch will blink to indicate the selected tempo.

Single mode

If set to **STOMPBOX (SINGLE)**, a sub-menu showing all effect modules in the current effect chain will be displayed. Select one by clicking on it. This module will then be directly turned ON/OFF by stepping on the respective footswitch in CTRL Mode. Confirm your selection by clicking **DONE**.

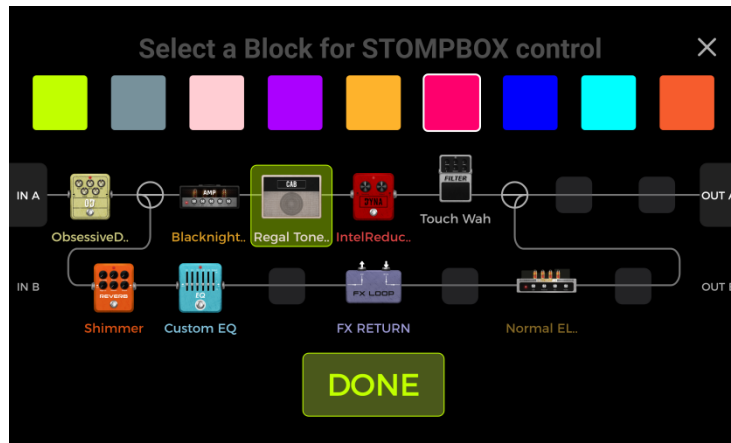

Sub menu in Single mode

Multiple mode

If set to **STOMPBOX (MULTIPLE)**, a sub-menu showing all effect modules in the current effect chain will be displayed. You can select several of them by clicking on them. These modules will then be directly and simultaneously toggled ON/OFF by stepping on the respective footswitch in CTRL Mode. Confirm your selection by clicking **DONE**.

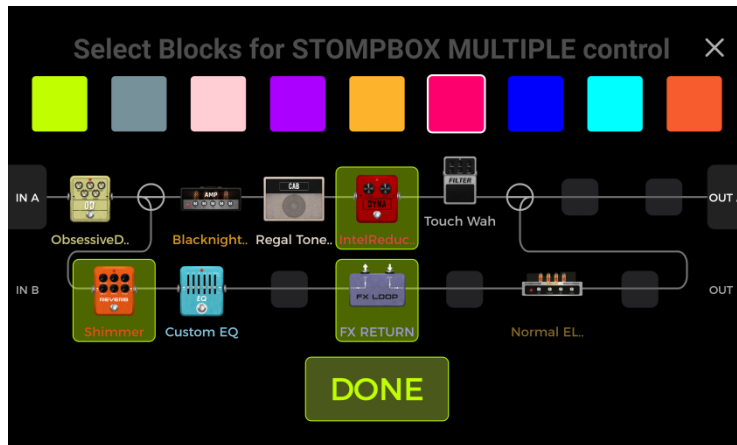

Sub menu in Multiple mode

In the top row of each selection screen you can select a color for the respective footswitch field in the CTRL screen to make finding the correct effect easier on stage (the same color will be used for the LED bar above the footswitch).

The field for a footswitch with multiple modules assigned will show a "Multiple" label and an icon indicating multiple effect modules.

A/B Mode

If the effects chain is configured with a split node and the mode of the split node is set to A/B switching, you can assign the A/B switching function to one of the B/C/D footswitches. Assigning an A/B switch is only possible after a split node has been set to A/B switching (see Split node). Otherwise this option will be grayed out and not available for selection.

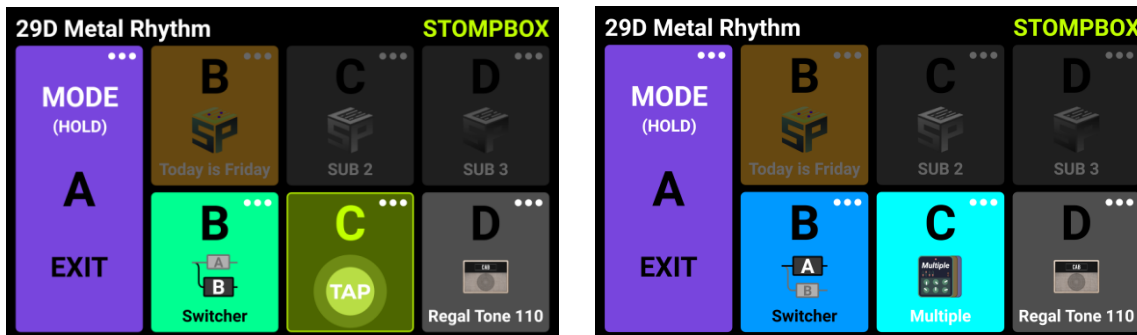

CTRL screen examples, showing properly configured footswitches in STOMPBOX mode

SubPatch mode

The SubPatch function allows you to change the on/off status of a module in the effect chain and at the same time also change the status of parameters with the same footswitch action. This way you can realize pretty dramatic changes in sound. You can change the type of the amplifier model, toggle a delay effect and modify the distortion, etc. - all without changing the preset. You can have three different SubPatches (Sub 1 - Sub 3) for each preset. They can be individually selected using the B/C/D footswitches.

Application scenario:

When using the Multiple mode described above, you may have wondered if you could change both the ON/OFF state of some modules and at the same time change parameter values with a single step of your foot. You can use the SubPatch mode to accomplish complex switching scenarios like this. You can load all the effect modules usually required by two completely different presets into one preset. In the **parameter settings view**, you can allocate parameter mappings to a corresponding group (SubPatch) by **long-pressing the parameter icon**. In **CTRL mode view**, you can adjust the combination of modules for the group. The following section describes the setup of a SubPatch in detail.

1. Mapping a parameter to a SubPatch

Method 1:

- Open the parameter editing view and **long-press the parameter** you want to control with SubPatch mode.
- Select **Setting SubPatch** in the pop-up menu. This opens a sub-menu for setting the parameter values controlled by SubPatches 1, 2 or 3 (Sub1 ... Sub3).
- Adjust the parameters and click **DONE** to confirm.
- You can click the Delete icon (-) on the right side of the parameter to cancel the parameter mapping.



A parameter mapped to a SubPatch will have the parameter name displayed between two asterisks to indicate the SubPatch mapping:



Method 2:

- Click the SubPatch icon in Edit View. A selection box for S0 - S3 will pop up (with S0 standing for "no SubPatch active").
- Select the SubPatch you want adjust. The parameter editing view will be opened.

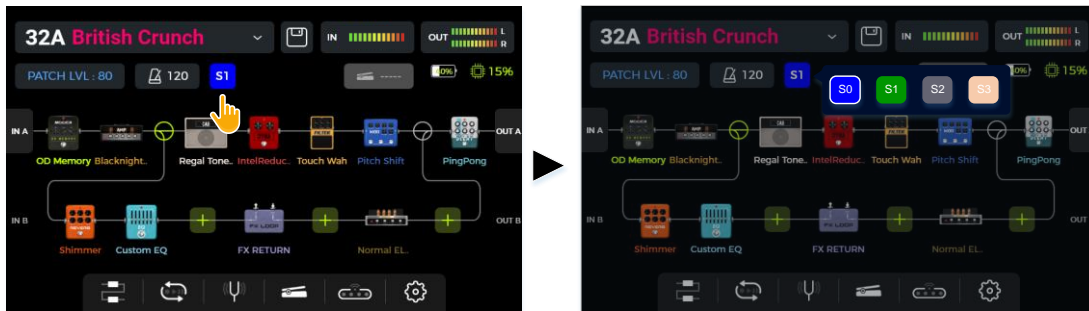

- The name of the parameter assigned to the SubPatch is shown between two asterisks.
- Modify the parameter using the touch screen or the SELECT knob. The modified value will be directly mapped to the current SubPatch.

2. Configuring the effect module switching status for a SubPatch

Method 1:

- Long press the SubPatch Icon in Edit View. This will directly open the SubPatch setting view.
- You can now slide the module icons in the effect chain slightly up/down to activate or deactivate them and thus define the combination of effects this SubPatch uses. The changes will take effect in real time.
- Click **DONE** to complete the settings.

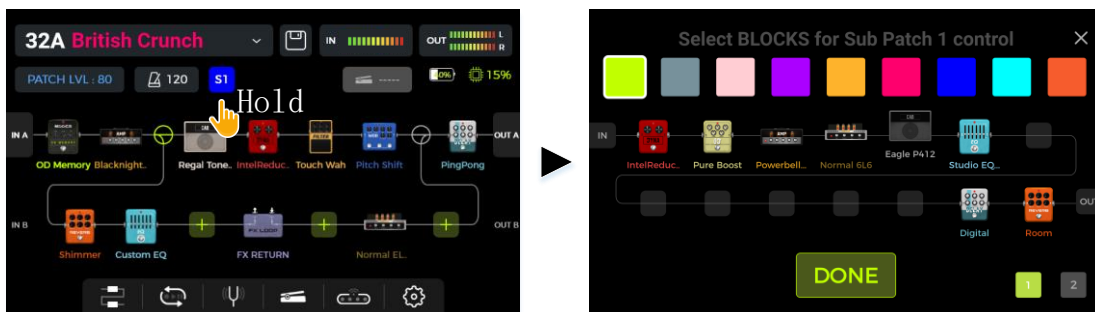

Method 2:

- Step on the footswitch for the currently active preset to open the CTRL mode view.
- Long-press the A footswitch, to switch the CTRL functions between STOMPBOX mode and SUBPATCH mode. Select SUBPATCH mode.
- In SUBPATCH mode, the upper row of B/C/D fields in the screen is highlighted. Click the ... icon in the upper right corner of the B/C/D SUB fields and select **SubPatch Setting** to view and adjust the settings for the respective SubPatch.
- A sub-menu showing the effect chain will be opened. Move the effect models to the desired positions and set their on/off status for the respective SubPatch. The changes will take effect in real time.
- You can also use the color blocks in the upper part of the screen to select a color for the SubPatch. This color will be used for the SUB field in the CTRL screen, for the LED bar above the footswitch, when this SubPatch is active and for the SubPatch Icon in the Edit view.
- Click **DONE** to complete the settings.

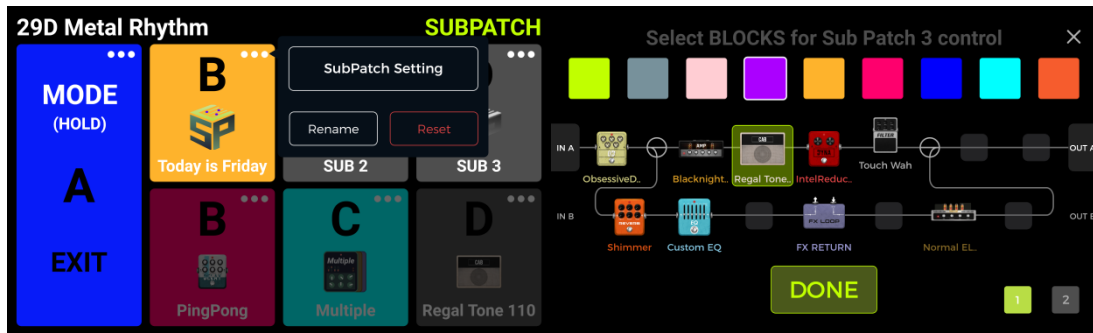

3. Modifying / deleting parameter settings in a SubPatch

1st method:

- Find the corresponding parameter in the parameter editing view.
- Long-press the parameter icon.
- Select **SubPatches** in the pop-up box.
- Set different parameter values for this parameter for the three SubPatches (Sub1 ... Sub3) or click the delete icon (-) on the right side of the parameter value to delete the mapping of this parameter for this SubPatch.



2nd method:

- In CTRL mode view, find the SubPatch using the parameter you want to modify and click the ... icon in the upper right corner of the SubPatch.
- In the lower right corner of the sub-menu, select the second page to view and modify the parameters mapped to this SubPatch.
- Click the delete icon (-) on the right side of a parameter to cancel the mapping of this parameter to this SubPatch.
- Click **DONE** to complete the setting changes

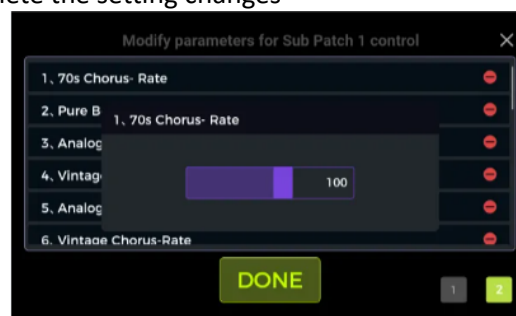

Note: You need to **save the preset** to make sure your setting changes are stored. They will otherwise get lost as soon as you change presets.

3rd method:

A parameter that has been mapped to any SubPatch will have its name marked with two asterisks. Once you have switched to the SubPatch to which this parameter has been mapped, you can adjust the parameter directly in the parameter editing area.



4. CTRL priority setting

The Preferences section in the Global Settings view has a Priority Mode setting, which sets the function mode that is active when you access the CTRL mode: SUBPATCH or STOMPBOX mode. The priority can also be set by clicking the ... icon in the upper right corner of the A field in CTRL mode view.

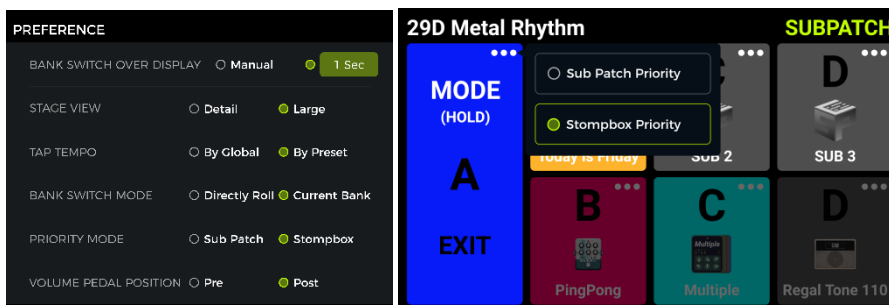

5. Renaming and clearing a SubPatch:

By default, the three available SubPatches are labeled SUB1, SUB2 and SUB3 in their respective fields in CTRL view mode.

Once you have configured a SubPatch, you can click the ... icon in a SubPatch field and select **Rename** to change the name of the SubPatch according to your needs. Use the pop-up keyboard, and click **DONE** to confirm the new name.

Next to the Rename function you will find a **Clear** button. Use this to clear all mappings to this SubPatch.

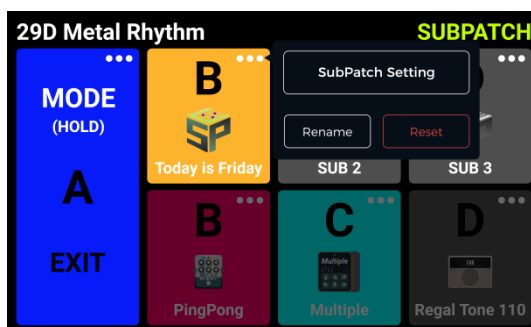

Expression Pedal

The GS1000 can be connected to an external TRS expression pedal (EXP connector on the back panel). The pedal can be used as volume pedal or as an expression pedal to control multiple modules and parameters.

Once an external pedal is connected, the pedal icon at the top of the main view interface lights up. The default setting is the volume pedal.

All settings such as the **parameter assignments or the use as volume/expression pedal** are different for each preset and **must be saved with the preset**.

Pedal calibration

You need to calibrate pedal before you use it for the first time. Calibration also needs to be carried out when you switch external pedals or if you experience erratic pedal function.

The **calibration is global** and does not have to be repeated for each preset.

Click the **pedal icon** at the bottom of the Edit View to open the expression pedal settings screen.

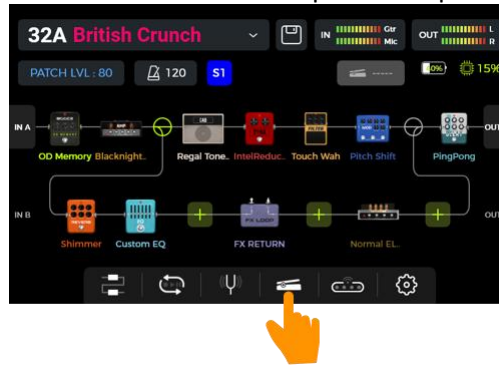

Click **CALIBRATE** on the left side and follow the instructions on screen:

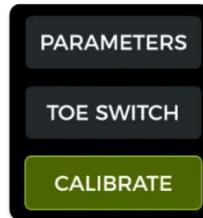

Flip the pedal all the way open and click **NEXT**.

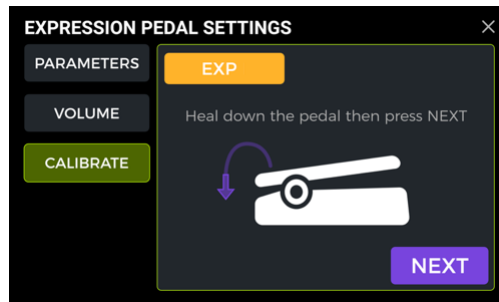

Close the pedal completely and click **DONE**.

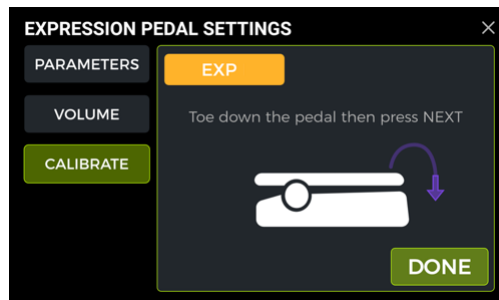

If prompted that the calibration was not successful, please confirm that the pedal was moved from fully open to fully closed between the steps or troubleshoot connection / wiring problems. Then repeat the steps again

Configuration as master volume pedal

If an external pedal is connected correctly, the pedal icon in the main view will be lit. Click on the pedal icon and then click "Setting to Volume" in the pop-up menu.



In **System Settings - Preferences**, you can set the volume pedal globally to **Pre** or **Post**. A **"Pre"** volume pedal controls the input volume of the effect chain, which also affects the gain of distortion modules. A **"Post"** volume pedal controls the total output volume, including the peripheral effects.

Configuration as expression pedal

Follow the same steps as above, but select "Setting to Parameters" in order to configure the pedal as expression pedal.

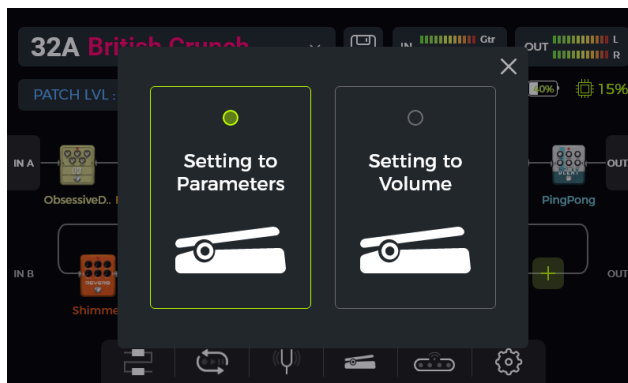

The expression pedal can be mapped to control several effect parameters of the same or different effect modules simultaneously.

All mappings affect only the current preset and must be stored with the preset. **Save your preset after mapping parameters** before you switch presets.

- In Edit view: double click the effect module you want to control with the expression pedal to enter the parameter editing screen.
- Long press the desired parameter until a context menu opens.
- Select **"Assign to EXP"** in the pop-up menu.
- Set the desired parameter values (in percent) for the closed and open positions of the pedal (e.g. "100" and "0" for normal operation or "0" and "100" for reverse operation, or any value in between).
- Click **"DONE"** to complete the mapping.

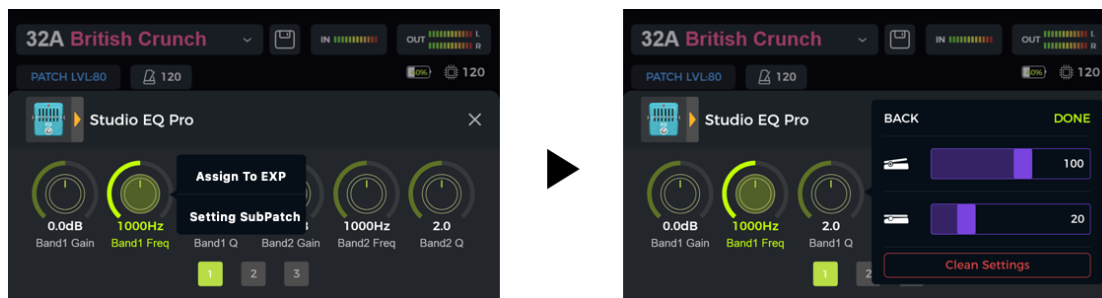

The parameters mapped to the expression pedal will have their name **highlighted in blue** to distinguish them from regular parameters. You can still adjust them manually, but as soon as you use the expression pedal, the manual setting will be overwritten by the expression pedal input.

All mapped parameters can be modified individually in the EXPRESSION PEDAL SETTINGS – PARAMETERS screen:

- Click the pedal icon at the bottom of the Edit View to open the expression pedal settings screen.
- Click **PARAMETERS** on the left side. All pedal mappings for the current preset will be listed.
- Click the parameter you want to modify, and adjust the values by sliding the bars or by rotating the SELECT knob.

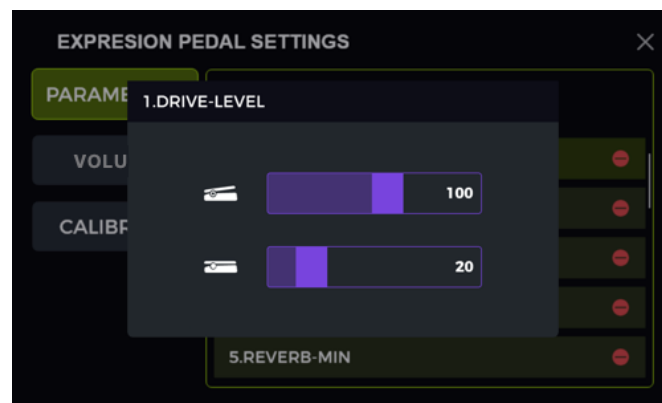

Remove expression mappings

Option 1: Find the mapped parameter (name highlighted) in the parameter editing interface. Long press the desired parameter. Select "EXP Settings" in the pop-up menu then click "Clean Settings" in the EXP Settings menu.



Option 2: Click the pedal icon at the bottom of the Edit View, to enter the EXPRESSION PEDAL SETTINGS screen. Click PARAMETERS on the left side.

In the list on the right: click the delete symbol (-) behind the parameter you want to remove.

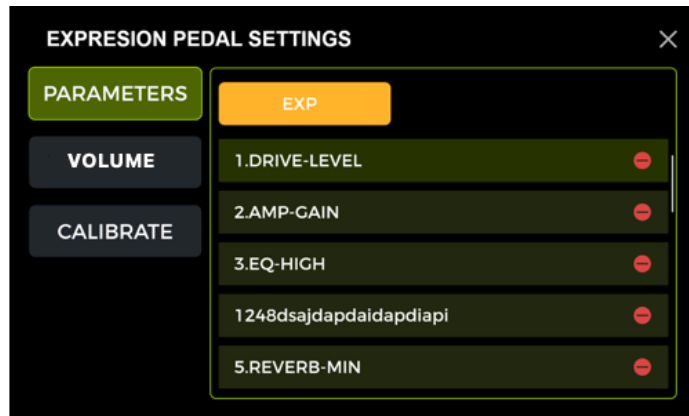

Volume Pedal Settings

Select **VOLUME** on the left side of the EXP pedal settings view to set **maximum** and **minimum** volume for the EXP pedal when it is used in volume mode.

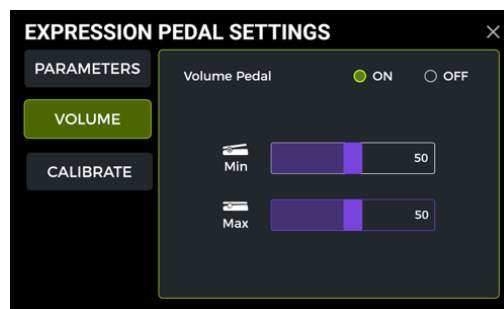

If you switch the volume pedal **OFF** in this view, the pedal can no longer be used as a Volume pedal, even if this is indicated by the symbol in the Main view.

USING EFFECT LOOPS

The GS1000 is equipped with jacks for a **single-port stereo effect loop**. This means that the SEND and RETURN jacks of the FX LOOP not only support the connection of mono devices, but can also be used to connect to external stereo devices using Y-format audio cable adapters.



(Single port stereo FX LOOP)



(TRS to dual TS adapter cable, Y-format cable)

The following section explains several conventional usage scenarios for effect loops.

Connecting external effect pedals

Connection method:

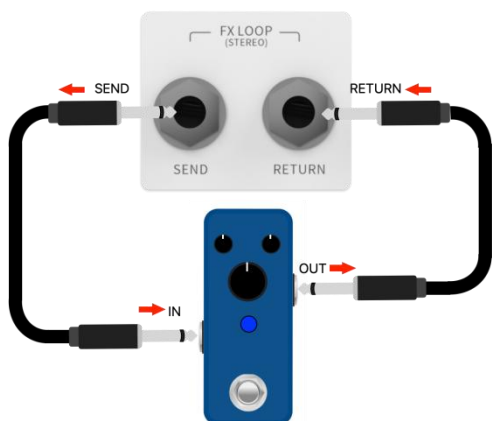

(Connection to mono effect)

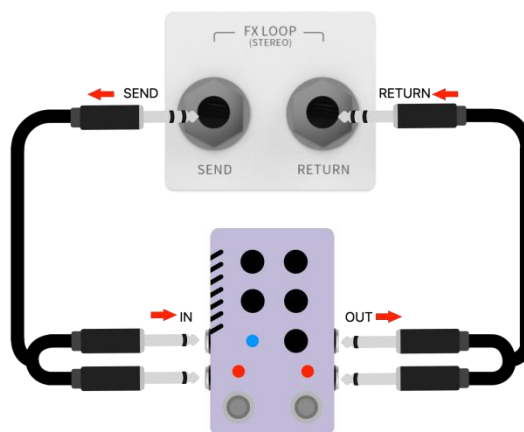

(Connection to stereo effect)

Note: After adding the FX LOOP module in the signal chain, you need to set the mode (mono/stereo) of "Send" and "Return" in the module parameters according to the actual connection situation.

Setting up the FX LOOP module

After completing the physical connections, you need to add the **FX LOOP module** to the effect chain in Edit View. There are two different ways to set up the FX LOOP module depending on the position of Send and Return in the effect chain:

Send/Return on the same node

(both SEND and RETURN occupy the same position in the effect chain)

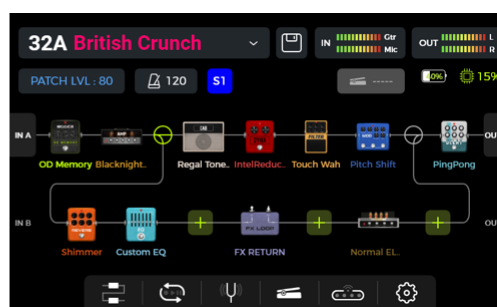

Click  in the desired position of the effect chain, and add the effect module "FX LOOP" with type "FX LOOP". This setting is suitable for most external effects that can be embedded in the GS1000 effect chain. The actual signal flow is shown in the figure below:

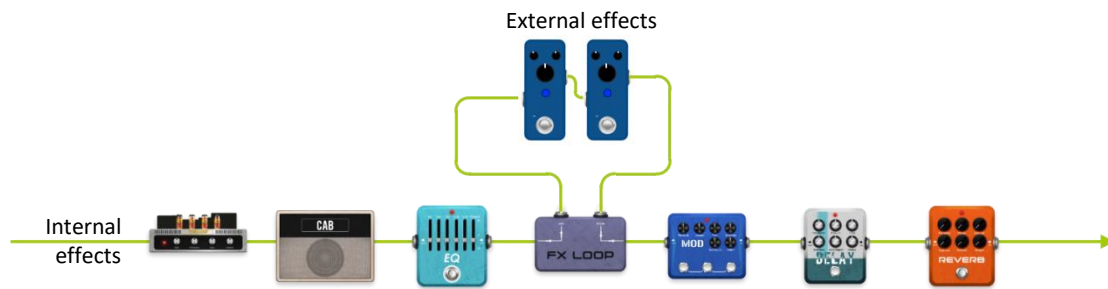

Send/Return on different nodes

(SEND and RETURN occupy different positions in the effects chain)

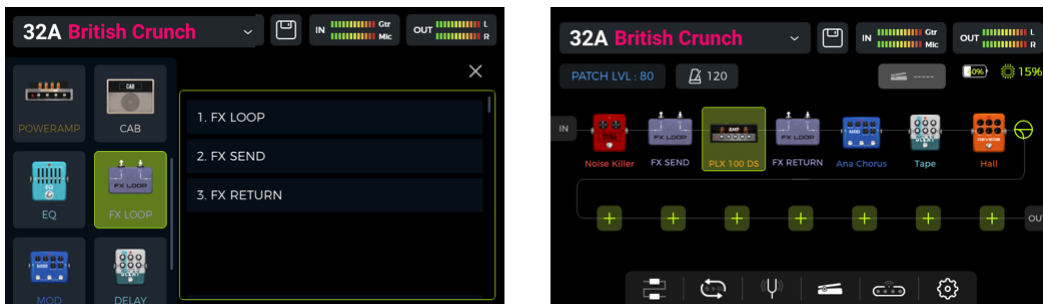

Add one effect module "FX LOOP" into the effect chain with type "FX SEND" and another one with type "FX RETURN". This setting is suitable for scenarios with the external effects in parallel with some of the internal effects or for A/B switching. The actual signal flow is shown in the figure below.

Effect loop set to **parallel connection** (FX SEND module set to Parallel Mode):

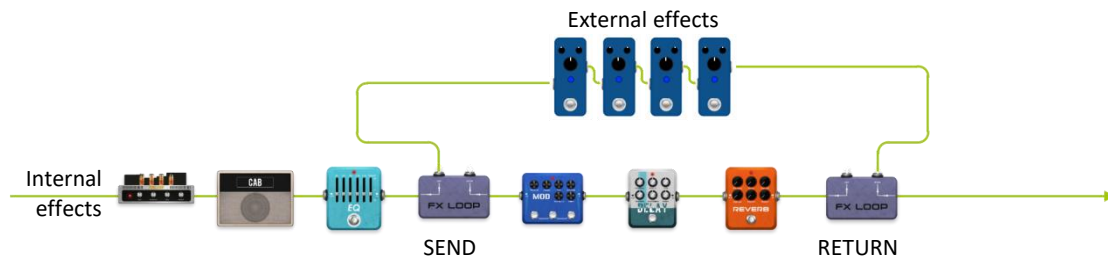

Effect loop set to **series connection** (FX SEND module set to Serial Mode):

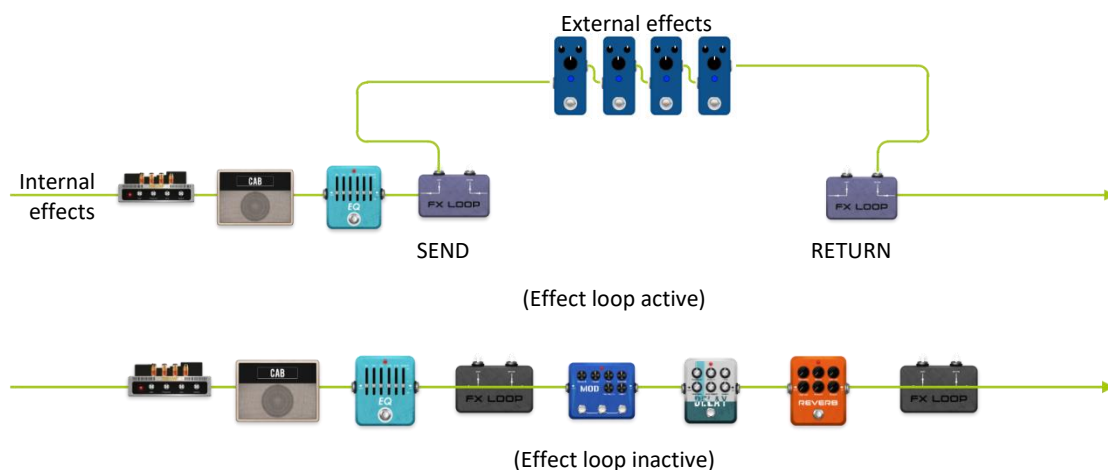

4-Wire connection method

As the name suggests, the four-wire connection method refers to two devices with effect loop capabilities connected to each other using four audio cables. This way, the two signal links are embedded into each other, in order to achieve the specific purpose for which this method was developed.

Connection method:

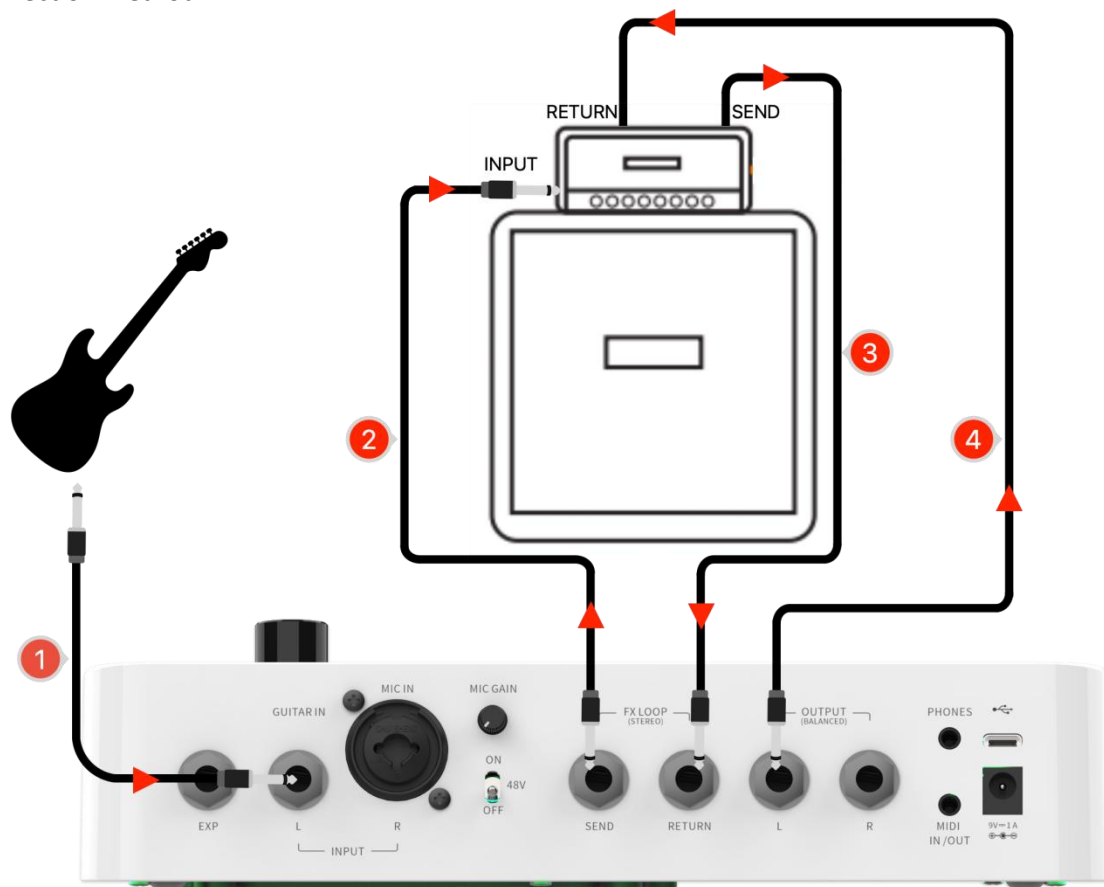

FX LOOP module settings:

Scenario 1: Splitting the GS1000 effect chain into pre-effects and post-effects.

When used with amplifiers, some effects (e.g. compression, overdrive, etc.) are better suited to be connected to the INPUT of the amp (**pre-effects**), while other effects (e.g. delay, reverb, etc.) are better suited to be connected between the pre-amp and the power amp (i.e. in the effects loop of the amplifier = **post-effects**).

You can achieve this scenario with the following setup in the GS1000's FX LOOP:

- Connect the GS1000 and the amplifier as shown in the connection diagram above.
- Add the FX LOOP module to the GS1000 effect chain.
- Move the **pre-effects** modules (effects suited to be plugged into the input of the amp) before the FX LOOP module.
- Move the **post-effects** modules (effects suited to be inserted in the effects loop of the amp) after the FX LOOP module.
- Set the Type in the FX LOOP module to "Mono" and the Mode to "Serial".

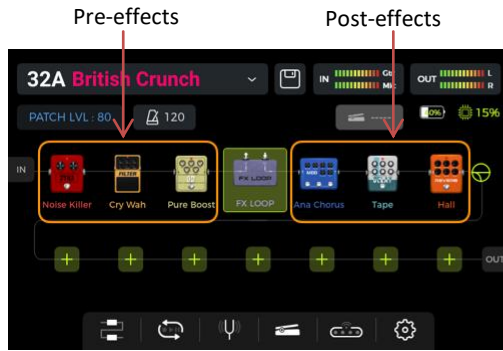

Select series mode

With these settings, the actual signal chain is configured as follows:

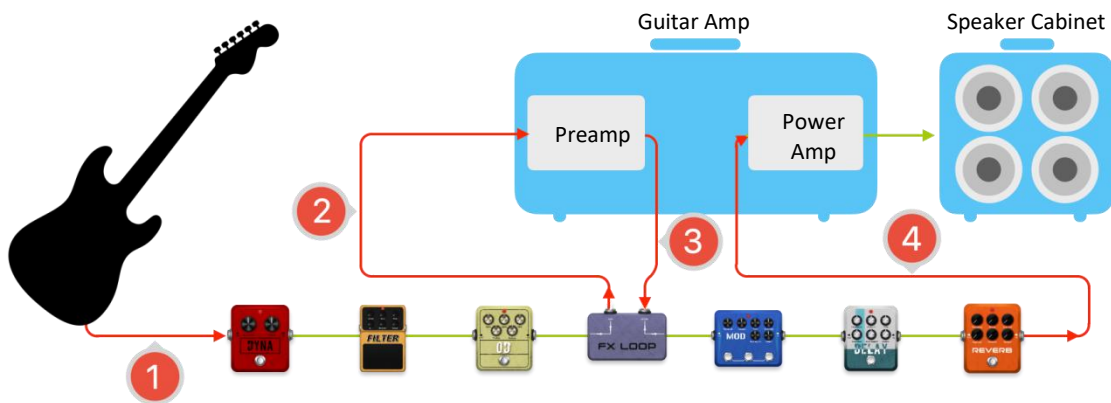

Scenario 2: A/B switching between the preamp simulation within the GS1000 and the physical preamp of the actual amplifier.

The same four-wire connection method can be used to realize **A/B switching** between internal preamp modules and a physical external preamp with the help of the FX LOOP module and a corresponding footswitch setting in CTRL mode.

- Add the FX SEND and FX RETURN modules to the GS1000 effect chain.
- Add an AMP module and select a preamp model (without cabinet).
- Move the AMP module between FX SEND and FX RETURN.
- Set the type in the FX SEND and RETURN modules to "Mono" and the Mode to "Serial".
- Configure one footswitch to control the FX SEND module in **CTRL mode**.



With these settings, the actual signal chain is configured as follows:

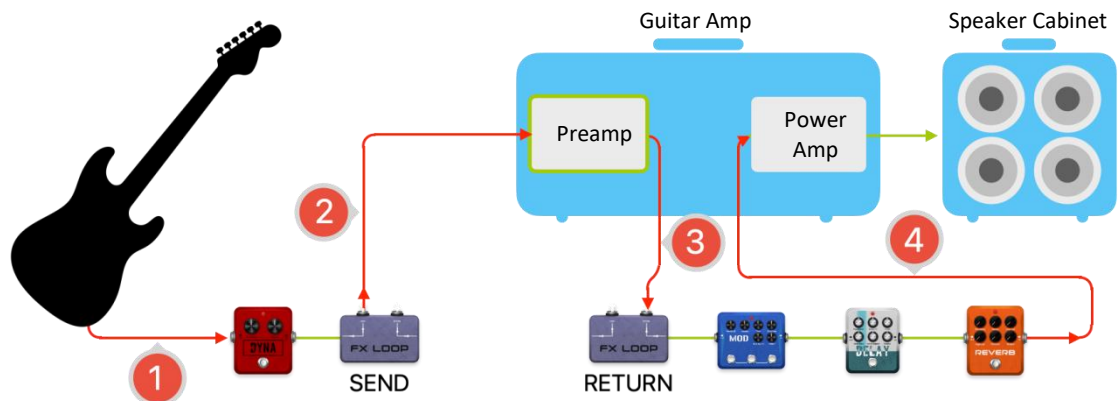

Activate SEND in CTRL mode to use the amplifier's preamp.

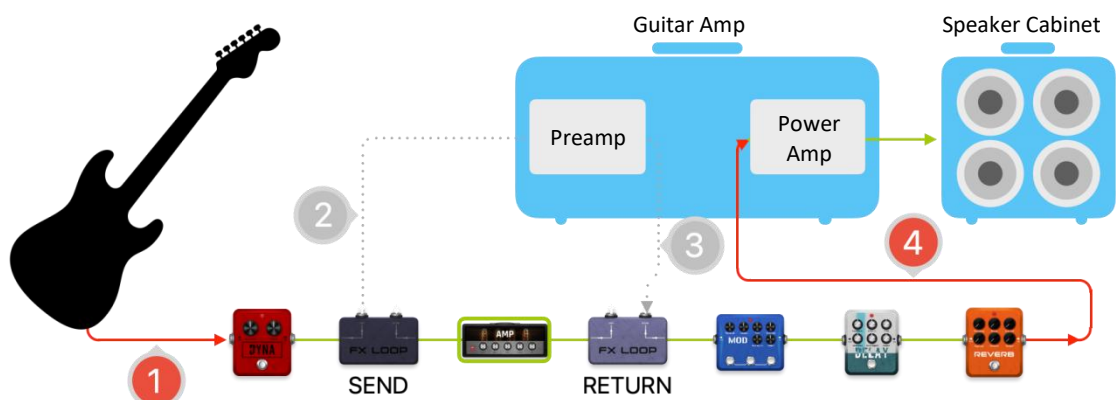

Deactivate SEND to use the internal preamp module.

Extended input and output options

The effect loop interface is essentially an input/output interface that can define its own position, with FX SEND as the output interface and FX RETURN as the input interface. When there is no requirement for external effects or four-wire connections, the FX LOOP can be used as an extended input and output interface for several common scenarios.

Scenario 1: Auxiliary Audio Input (AUX IN)

- Add the FX RETURN module to the GS1000 effect chain.
- Move it to the appropriate position or to the very end of the effects chain if you don't want the incoming audio to pass through any internal effect modules.
- Connect an external audio source to the FX LOOP RETURN.
- Select the type in the FX RETURN module as 'Mono' or 'Stereo' depending on the audio source.

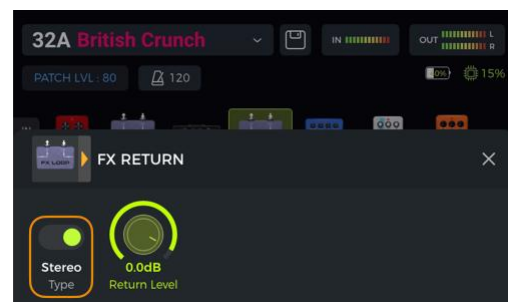

Scenario 2: Expanded output mode (e.g. different outputs with or without cab simulation)

- Add the FX SEND module to the GS1000 effect chain.
- Move it before the CAB module in the effect chain.
- Select the FX SEND module mode as "Parallel" and the wet/dry ratio as "50:50".



With these settings, the signal output from the FX SEND output does not have cab simulation applied, and the signal output from the other outputs includes a cab simulation.

MNRS PROFILING

The MNRS Profiling function of the GS1000 allows you to "pocket" the sounds of your favorite pieces of physical equipment (overdrive pedals, preamps, entire amplifiers or cabinets) and save and share the sound files via cloud using the MOOER STUDIO computer software and the MOOER CLOUD mobile app. This section explains how to capture the sound of these devices.

Press the "PROFILING" button on the GS1000 to open the capture interface. If you use the feature for the first time, please read the disclaimer statement, check the "I have read ..." radio button and click on NEXT.

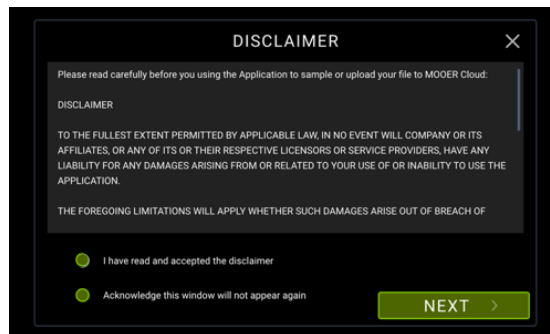

In the sampling mode selection interface, select the type of device you want to capture. The acquisition process is the same for overdrive, preamplifiers and full amplifiers.

The following is an example of the acquisition of a full amplifier profile and a speaker profile:

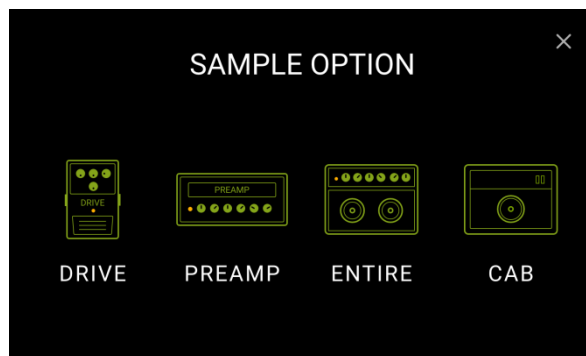

Caution: During the acquisition process of an entire amplifier or a speaker cabinet, a series of **loud sampling signals** will be played through the physical equipment. Make sure to provide sound insulation and volume protection.

Full amplifier sampling

Select the "ENTIRE" icon.
Connect the equipment according to the connection diagram on the screen and click **NEXT**.

(A microphone and an XLR cable are required for full amplifier sampling.)

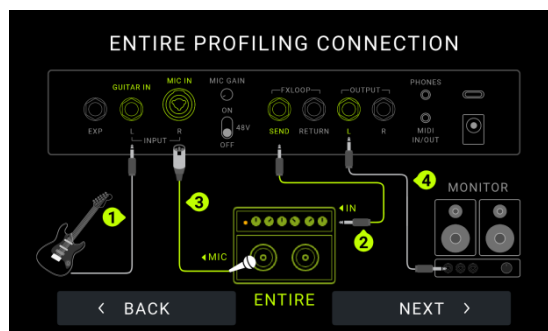

After opening the sampling interface, you can monitor the current target tone signal in real time from the 1/4" output and the headphone jack. In this step, you can confirm the target sound and the microphone position. After confirming the sound, click **SAMPLE** to start the acquisition process.

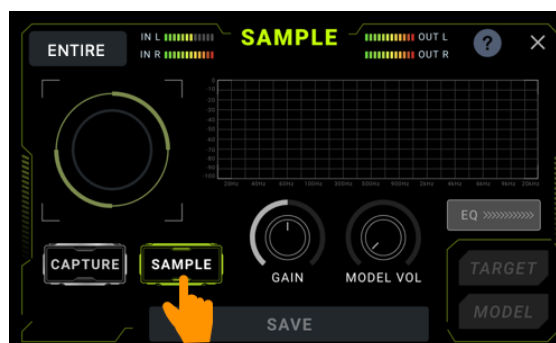

If there is an indication that the volume is too loud or too low during sampling, make adjustments on the acquisition target as appropriate.

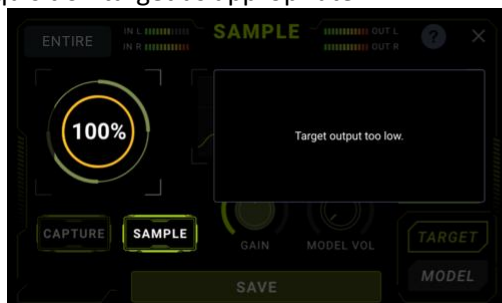

(Turn the output volume of the target up)

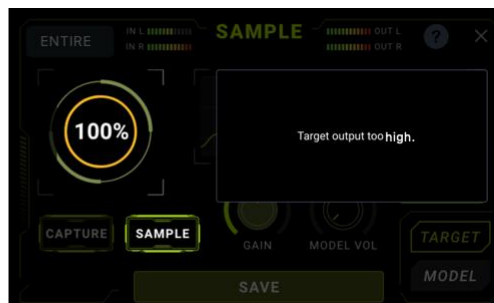

(Turn the output volume of the target down)

Once the sampling progress on the interface reaches 100%, sampling is completed, and you can click on the **TARGET** tone and the sampling **MODEL** to switch between them and listen to them for comparison. The spectrum diagram in the interface follows the switching between **TARGET** and **MODEL** and displays the spectrum status of the current sound in real time.

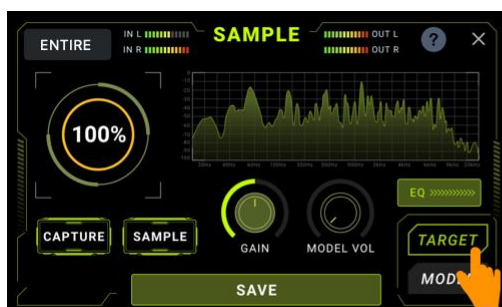

(Listen to real target)



(Listen to sample result)

At this point, the sampling is completed. If you wish to further correct the results you can continue to make adjustments as follows:

Volume and gain level fine tuning:

If the sampling result needs to be adjusted in terms of volume or gain, use the Gain and Model Volume knobs in the interface adjust the parameters.

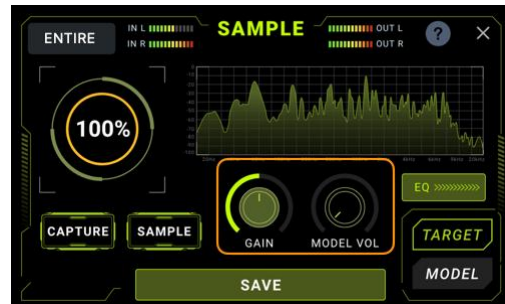

Tone Capture:

The second step is to capture your instrument to fit its sound characteristics to the sampled equipment.

Click on **CAPTURE**.

Strum strings 6 to 1 in increments from the open string all the way down the fingerboard.

The entire process needs to cover as much of the fingerboard as you intend to play during your performance. The tone correction will be completed when the display shows 100%.

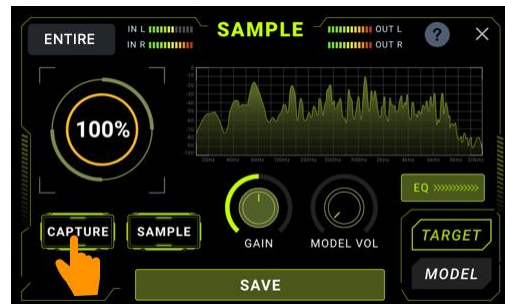

Manual EQ Adjustment:

Click on the EQ field to open the screen for manual equalization adjustment. This features three adjustable equalization bands, and you can use the graphic spectrum to assist in manual equalization adjustment.



Tap the area below each knob to cycle through Gain, Frequency and Q adjustments for the band's equalization, and rotate the knob to change the value.



During the adjustment process, you can click on the TARGET tone and sample MODEL at any time to switch between them for comparison.

Click SAMPLE in the lower left corner to return to the sampling interface.



Save sampling results

Click the SAVE button to save the profile.

The current file type is shown at the top of the screen.

Click on the slot selection box to select the storage location where you want to save the file.

Enter a name using the keyboard and click SAVE.

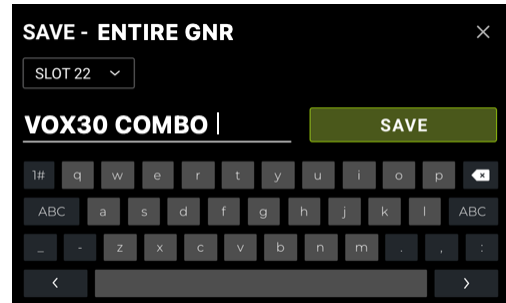

After saving, the sample file can be found in the "GNR" list of the corresponding effect module.

Speaker cabinet sampling

Select the "CAB" icon.

Connect the equipment according to the connection diagram on the screen and click **NEXT**.

(An amplifier with a RETURN jack or a pure power amp is required for cabinet sampling.)

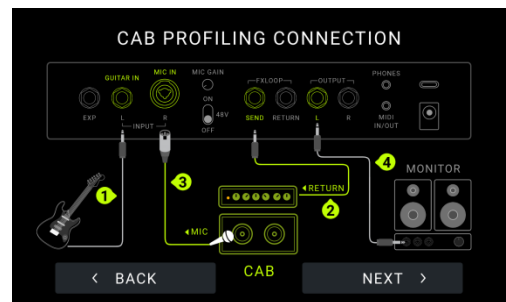

After opening the sampling interface, you can monitor the current target tone signal in real time from the 1/4" output and the headphone jack.

This signal represents the built-in preamplifier model played through the physical speaker cabinet.

In this step, you can adjust the microphone position.



Click the model selection box of the built-in preamplifier to select other types. The parameters under the model selection box can be adjusted for the tone of the preamp model.



Note: The selection of the preamp model will not affect the sampling result. This is only used to help you confirm the sound of the cabinet before sampling.

After confirming the sound, click **SAMPLE** to start the acquisition process. If the volume is too high or too low during the sampling process, please adjust the acquisition target (the output volume of the power amp) according to the situation.

Once the sampling progress on the interface reaches 100%, the sampling is completed, and you can click on the **TARGET** tone and the sampling **MODEL** to switch between them and listen to them for comparison. The spectrum area in the interface follows the switching between **TARGET** and **MODEL** and displays the spectrum status of the current Master sound in real time.



(Listen to real target)



(Listen to sample result)

Save sampling results

Click the **SAVE** button to save the profile. The current file type is shown at the top of the screen. Click on the slot selection box to select the storage location where you want to save the file. Enter a name using the keyboard and click **SAVE**.

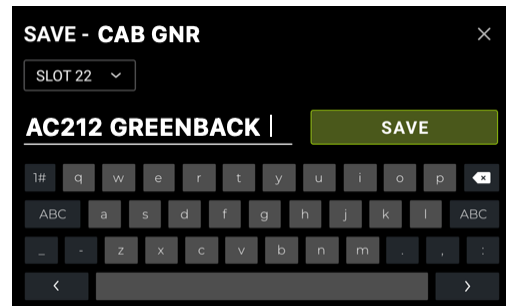

After saving, the sample file will be found in the "GNR" list of the corresponding effect type.

TUNER

The integrated tuning feature can be accessed in two different ways:

- Click the **tuning fork** icon in the Edit View.
- Hold footswitches **A** and **B** down simultaneously until the Tuner screen opens.

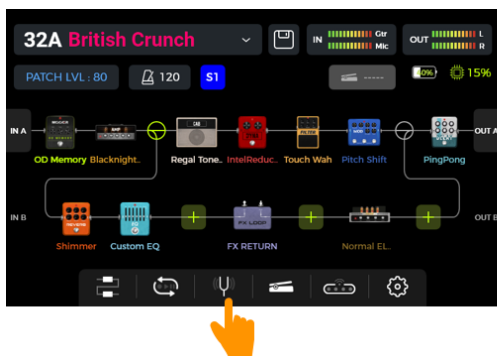

Tuner screen

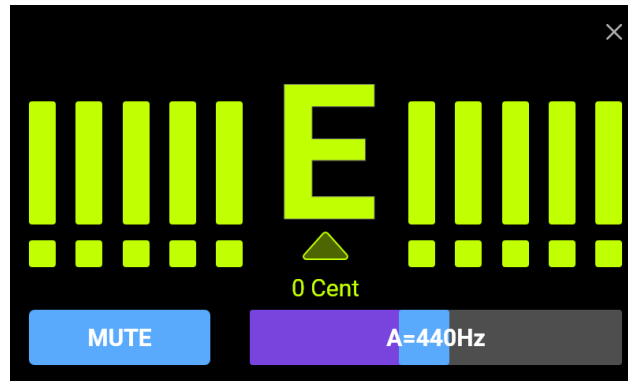

Click the field in the lower left corner or press the **SELECT** knob to switch between **BYPASS** tuning mode or **MUTE** tuning mode.

BYPASS tuning disables the internal effects and sends a **clean signal** to the outputs for as long as the tuning mode is active.

MUTE tuning mutes the outputs for as long as the tuning mode is active.

Adjust the **reference frequency** by moving the slider in the lower right corner or by rotating the **SELECT** knob. You can select a reference frequency from a range of 430 Hz - 450 Hz. The default value is A = 440 Hz.

Tuning

- Open the tuning screen.
- Pluck the open strings of your guitar. The screen will display the current note and the pitch.
- Tune your guitar until the pointer on the screen is in the center position.

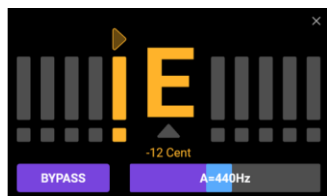

Flat

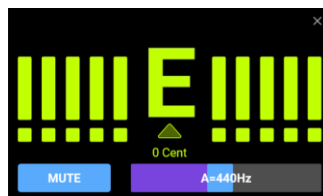

In tune

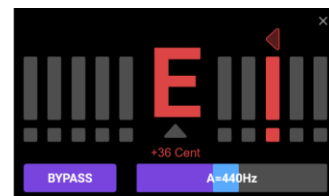

Sharp

Exit tuning mode

Use any of the following methods to exit the tuning mode:

- Click the "X" in the upper right corner.
- Press any footswitch once.
- Hold footswitches A + B down simultaneously.
- Press the HOME button.

GROOVE STATION

The Groove Station combines drum machine and phrase Looper functions. You can use these features independently or in combination. Synchronization is supported, when Drum Machine and Looper are used at the same time.

Open the Groove Station

There are two ways to open the Groove Station mode:

- Click the **Groove Station icon** at the bottom of the Edit View screen.
- Hold footswitches **C and D** down simultaneously until the Groove Station screen opens.

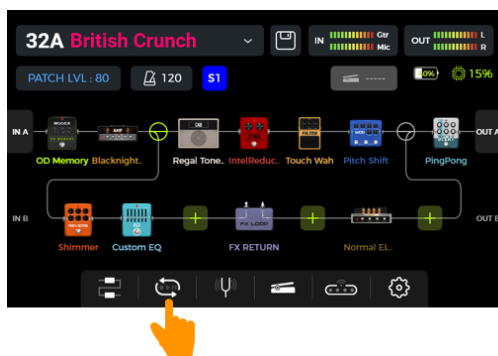

Groove Station screen

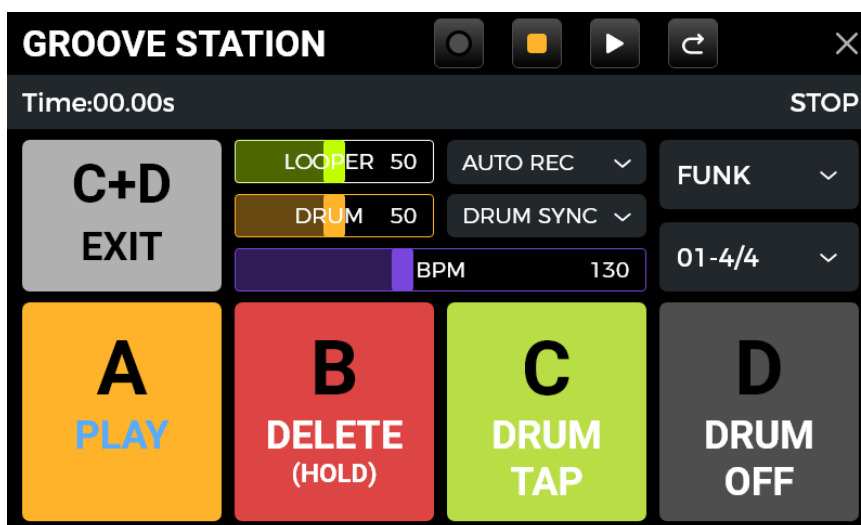

The five large square icons in the Groove Station screen indicate the **footswitch functions that will be performed when the respective footswitch is pressed the next time**. You can click the squares on the touch screen or press the corresponding footswitches to perform the functions.

The **icons at the top** indicate the REC/PLAY/STOP/REDO/UNDO status of the Looper.

The **progress bar** below indicates the recorded time as well as the current status and the position of the phrase loop during playback.

The center area shows several settings for the Drum Machine and the Looper. They will be explained in the respective sections below.

Volume sliders

The sliders for **LOOPER** and **DRUM** control the respective output volumes and can be controlled by swiping the sliders or by clicking them and then rotating the SELECT knob. The number in the slider indicates the volume in percent.

Drum Machine

Click the drop-down menus on the right side of the screen to select the **Style** (FUNK, POP, ROCK ...) for the Drum machine and also a **Rhythm Pattern** (4/4, 6/8 ...).

Footswitch C: DRUM TAP

- Press C several times to tap in the desired tempo for the drum machine. The selected tempo is indicated graphically and numerically in the **BPM bar** and, with the Drum Machine running, by the blinking the **LED Bar** above C. You can also swipe the **BPM slider** in the BPM bar to set the value or click it and fine-tune with the SELECT knob.

Footswitch D: DRUM ON / DRUM OFF

- Press D to start / stop the Drum Machine.

Looper

The GS1000 features a Looper with up to 480 seconds / 8 minutes of recording time, overdubbing function and independent level control.

Footswitch A: REC / PLAY / DUB / UNDO / REDO

- **Tap once** for **Record**, tap again for **Play**, tap again for **Dub...**
- **Hold** for **Undo**, hold again for **Redo** (after recording more than one layer of Looper track).

Footswitch LED bar indication for A:

- **Solid Red:** Recording mode
- **Solid Blue:** Playback mode
- **Solid Purple:** Overdub mode

Footswitch B: STOP / DELETE

- **Tap once** to stop playback/recording
- **Hold** to delete the entire recording

Footswitch LED bar indication for B:

- **Blinking green:** the Looper is in Stop mode
- **Solid purple:** all recordings have been deleted

Looper Auto Record

Activate **AUTO REC**, adjust the appropriate trigger threshold, and press footswitch A to activate the **standby** function.

The Looper will start recording as soon as the input signal triggers the threshold. When Auto Record is not active, the recording starts immediately with pressing **A**.

Drum synchronization

Activate **DRUM SYNC** to synchronize the Looper function with the Drum Machine when both features are to be used at the same time. This way, they will both be in synch with regard to the bar structure.

- Pick the style and rhythm pattern for the Drum Machine first, and set the desired tempo.
- Activate DRUM SYNC.
- Execute "REC" for the Looper (Footswitch A).
A **one-bar count-in** will be played, based on the selected rhythm pattern.

- Recording will begin after the count-in, and the Drum Machine will start playing in sync with the Looper recording.

To ensure proper synchronization between the two features, at the end of the first layer of recording (in "Play" mode) and after the Looper has reached an integer number of measures, the remaining part of the phrase loop that is less than one measure will be processed in 1/2 measures: less than 1/2 measure will be trimmed, and if it exceeds 1/2 measure, playback will be delayed until it reaches a full measure.

Take a 4/4 beat as an example: When you record to the third beat of the fourth bar, playback will be executed (more than 1/2 bar), the LOOPER will record the fourth full bar and then switch to playback. The length of the loop is 4 full bars.

If playback is executed when the recording of the fourth bar ends on beat 1 (less than 1/2 bar), the LOOPER will discard the extra content of the fourth bar and immediately start playback from the beginning, and the length of the loop will be 3 full bars.

Note: In the following cases, there will be **no count-in** when synchronization is turned on:

- AUTO RECORDING is active.
- The Drum Machine is already running before the Looper recording is started.

Close the Groove Station

Use any of the following methods to exit the Groove Station Mode:

- Click the "X" in the upper right corner.
- Press footswitches C + D simultaneously.
- Press the HOME button.

Note: If the Looper and/or the Drum Machine are playing when you close the Groove station, **they will continue playing**. You need to re-open the Groove Station in order to stop the Looper and/or the Drum Machine. Alternatively you can assign DRUM ON/OFF to the optional F4 wireless footswitch and operate the Drum Machine without opening the Groove Station.

(See *F4 WIRELESS FOOTSWITCH*).

USB DIGITAL AUDIO

The GS1000 supports 24-bit, 44.1 kHz - 192 kHz low-latency sound card functions and supports most of the host software available for Windows and Mac systems. Windows system users need to install a special ASIO driver to realize low latency recording/monitoring. Please visit the official website to download the Windows ASIO sound card drivers. Mac users do not need to install the sound card driver. The system is plug-and-play for Mac.

Parameter descriptions

You can find the parameter settings for "USB Audio" in the GLOBAL SETTINGS screen.

Press the SETTINGS icon on the main screen and scroll down to USB AUDIO.

Adjust the mode and parameter setting to the requirements of different usage scenarios.

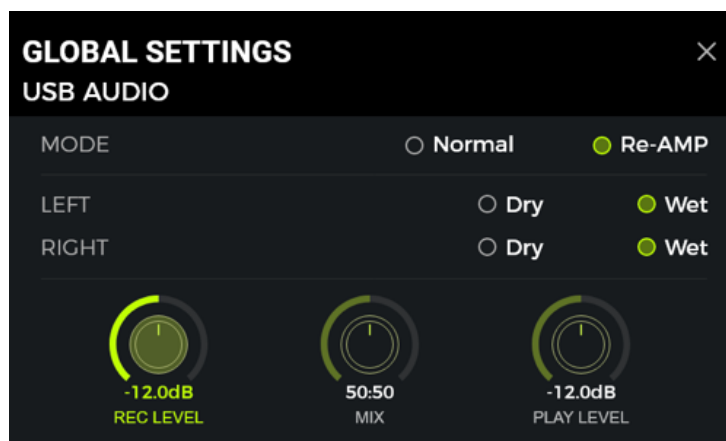

Usage Modes

Normal mode: You can use the GS1000 like an external sound card. The input will be automatically taken from the input jack of GS1000 (your guitar), and the output will be sent to the USB output port (digital signal) from the GS1000 to your computer.

Re-AMP mode: You can use the GS1000 as a sound card and at the same use the digital audio signal processing features. The USB signal input of the GS1000 (digital signal received from the computer) will be automatically used as input, and the USB output (digital audio signal) to the computer will be used as output.

The default factory setting for the GS1000 is **Normal**.

Left channel / Right channel:

When using the sound card recording function, these two switches can be used to determine whether the left and right outputs receive dry sound or processed effect sound. When "DRY" is selected, the output signal of the currently selected channel is not processed by the effect modules. When "WET" is selected, the output signal of the currently selected channel is processed by the effect modules. Selecting the left and right output signals as dry or wet can be convenient to preserve the dry signal for post-processing when recording. This way you can listen to the wet signal and record the dry signal.

The default factory setting for the GS1000 is "WET" for both the left and right channel.

Record Level: Adjust the recording level of the sound card function. The default factory setting is 0 dB.

Mix Ratio: Adjusts the mix ratio between hard and soft monitoring.

A setting all the way to the left means that 100 % of the signal is coming from the GS1000 (hard monitoring). All the way to the right means that the 100 % of the signal comes from the computer/DAW/plug-in, etc. (soft monitoring). With a center setting of 50:50, the ratio of hardware output to USB digital input is 1:1.

The default factory setting is a 50:50 mix of hard and soft monitoring.

Playback Level: Adjusts the volume level of the digital input of the sound card function, i.e. playback volume. The default factory setting is 0 dB.

Mode descriptions

Normal mode

In this mode, the GS1000 will act as an external sound card with effects and the computer software can be used for recording. The signal path of this mode is shown below:

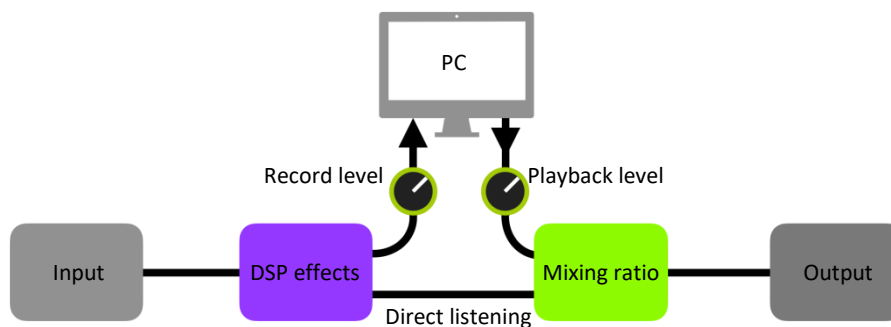

Setup:

- Set the Audio Mode to **Normal**.
- Open the recording software on the computer and configure it to use the GS1000 sound card driver. Then set the input and output ports to "Analog1/Analog2" of the GS1000 .
- Adjust the **Wet** and **Dry** settings for the left and right channel depending on the recording / monitoring requirements.
- Record a track, and pay attention to the input level indication to make sure there is no signal distortion (clipping) even with hard playing. If the input signal is too strong, adjust the **Recording level** accordingly.
- Play back the recorded track or other audio files to make sure that the return volume is appropriate (for different monitors, such as headphones or monitors), and adjust the **Playback level** accordingly.
- By playing the audio file through the GS1000, you can balance the volume ratio between the recorded audio and the live signal by adjusting the **Mix Ratio**.
- Confirm the input and output levels and start recording.

Re-Amp mode

The Re-Amp recording mode is a digital audio signal reprocessing method, which can be used to run a dry signal track from a computer through the effect modules of GS1000, and then record it as a new "wet" track. The signal path of this mode is shown below:

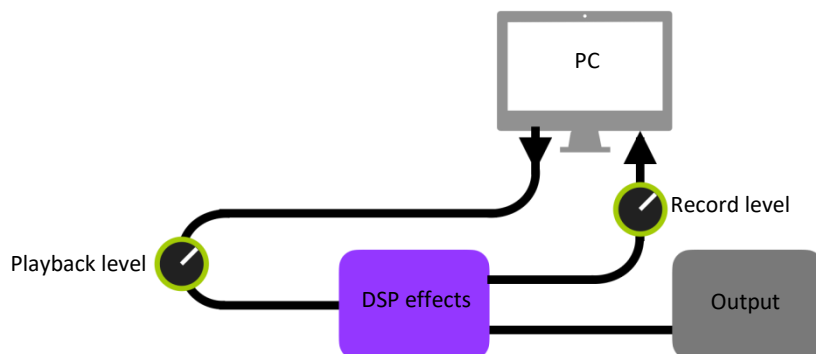

Setup:

- Open the recording software and add two tracks. One of them is a dry track that needs re-amping (pre-recorded or other audio track), the other one should be a blank track.
- Play the dry track through the GS1000 DSP effects and make sure the input level indication in the PC software shows no distortion (clipping). Adjust the level with **Record level**.
- While playing the dry track, you can also adjust the switches and parameters in the GS1000 for the desired Re-Amp effect. Listen to the output and adjust the level using the **Playback level** control.
- Select the blank track, activate the recording and play the dry track. Re-Amp is complete, when the dry track is finished.

Note:

- After starting the recording software, you should set the GS1000 driver as input driver in the system settings or in the driver settings of the recording software. Also set the input and output ports to the input and output of the GS1000. Otherwise you could experience no input, no output, excessive lag or other abnormal conditions.
- When using Re-Amp mode, please select the effect chain mode as serial mode.
- After the Re-Amp function is activated, the **input source of the effect chain will be fixed to USB**, and this limitation will be restored after the USB mode is selected as Normal.
- We recommended that you do not try to adjust settings or operate switches on the GS1000 during the Re-Amp recording process, unless this is required for special effects. This may result in undesired results.
- Should you encounter too much lag, open the sound card driver control panel and adjust the cache settings to achieve a shorter lag time.
- After using the Re-Amp function, we recommend **switching back to Normal mode**. Otherwise the pedal may boot up in Re-Amp mode when started the next time and there will be no signal from the guitar input as the input would still be set to USB input.

BLUETOOTH AUDIO

The GS1000 supports a Bluetooth connection to play back audio material from other devices such as Smartphones or tablets.

The Audio signal coming in over Bluetooth will be mixed with the signal from your guitar so you can use this feature for practice or to play along to an audio track.

- Open the GLOBAL SETTINGS screen on your **GS1000** by pressing the SETTINGS icon and scroll down to BLUETOOTH to activate the Bluetooth function for the GS1000.
- Open the Bluetooth settings of your **mobile device** and make sure Bluetooth is active.
- Find "GS1000 Audio" in the list of available devices.
- Click "Connect" to be able to play music through the Bluetooth input of the GS1000.
- **Use the volume controls on your device** to control the input volume at the GS1000 and thus the mix of the Bluetooth audio and the audio generated by your guitar playing through the GS1000.

MIDI CONFIGURATION

The GS1000 is equipped with a 3.5 mm TRS-type MIDI interface, and can be configured to send MIDI commands (MIDI OUT) or to receive them (MIDI IN). MIDI settings are global settings and apply to all presets.

Open the Global Settings screen by clicking the **settings icon** and scroll down to the MIDI settings.

Select "**Controller**" to configure the GS1000 as a **MIDI controller**, sending commands to other connected MIDI devices to control preset switching and other functions.

Select "**Slave**" to configure the GS1000 as a **controlled device** that receives control commands from other MIDI devices.

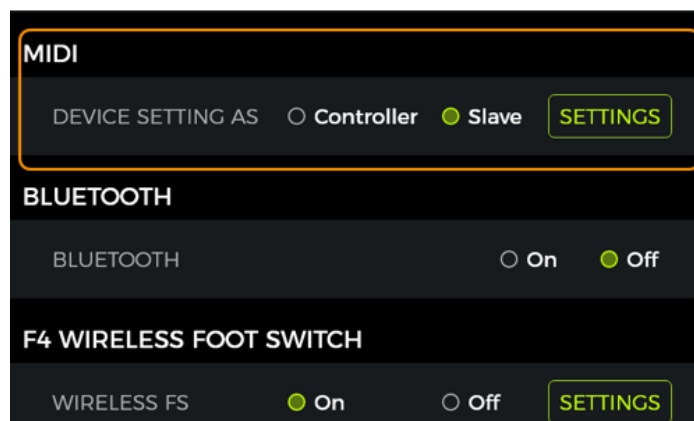

Supported MIDI commands

MIDI command	Send	Receive
Channel	1 -16	1- 16, Omni
MIDI Note	Not supported	Not supported
Program Change (PC)	supported	supported
Continuous Control (CC)	Not supported	supported
Synchronization	MIDI Clock supported	MIDI Clock supported
other	Not supported	Not supported

GS1000 as controlled device

To configure the GS1000 as a controlled device, click the Settings icon, scroll down to MIDI, select "Slave" and click "Settings" to enter the configuration page. The following options are provided:

MIDI Channel

Click CHANNEL and select the MIDI command channel that the GS1000 is supposed to respond to. The factory default is channel 1.

OMNI means the GS1000 will ignore the channel information and respond to the command directly. This simply means that no matter what channel is set by the transmitting device, the GS1000 will respond to the corresponding MIDI command.

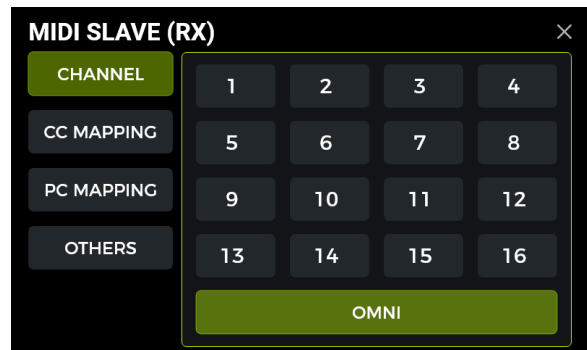

CC Mapping

In this list, you can set the function for each received CC code. The factory default is "Empty". You can choose from a list of functions, depending on your needs.

The following functions can be controlled with CC commands (this list may be incomplete and the items may not be listed in the same order as in the on-screen menu).

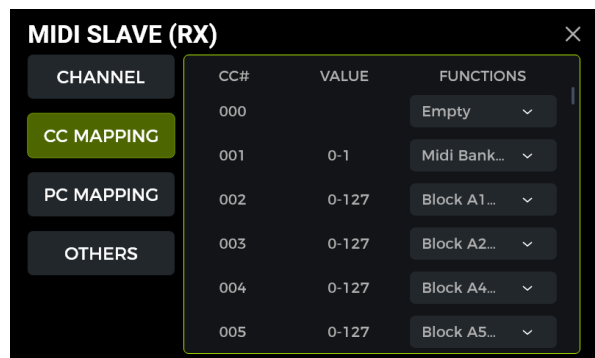

Function	Value	Comments
Empty	none	No function selected
MIDI Bank Select	0, 1	Corresponds to switching between two banks within the PC list, with 128 presets mapped to each bank (see PC Mapping below).
Block A1 – B7 toggle	0 - 127	Toggles the effect module in the specified position of the effects chain ON/OFF. Block A includes positions 1-7 of the effect chain. Block B includes positions 8-14.
Patch Level	0 - 127	This corresponds to controlling the PATCH LEVEL (preset volume) in the Edit View.
Tap Tempo	0 - 127	This command is sent to the GS1000 continuously, and the interval is used as the value for the tempo setting.
Guitar input level	0 - 127	Controls the Guitar input volume in the Global Input settings.
Mic input level	0 - 127	Controls the Microphone input volume in the Global Input settings.
Noise Reducer	0 - 127	Corresponds to the Noise Reduction switch in the Global Input settings.
1/4" output level	0 - 127	Controls the volume of the 1/4" output in the Global Output settings.
Phones output level	0 - 127	Controls the volume of the headphone output in the Global Output settings.
USB output level	0 - 127	Corresponds to the volume of the USB audio output in the Global Output settings.
Global EQ toggle	0 - 127	Corresponds to the Global EQ switch in the Global Output settings.
Global Cab Bypass	0 - 3	Corresponds to the Global Cab Bypass switch in the Global Output settings. 0: This function is not turned on for either the left or right channel; 1: Bypass is turned on for the left channel and off for the right channel; 2: Bypass is turned off for the left channel and turned on for the right channel; 3: Bypass is turned on for both left and right channels.
Global Power Amp Bypass	0 - 3	Corresponds to the Global Poweramp Bypass switch in the Global Output settings. 0: This function is not turned on for either the left or right channel; 1: Bypass is turned on for the left channel and off for the right channel; 2: Bypass is turned off for the left channel and turned on for the right channel; 3: Bypass is turned on for both left and right channels.
Global Limit Switch	0 - 127	Corresponds to the Limit switch in the Global Output settings.
Groove Station enter/exit	0 - 127	Open / close the Groove Station.
Looper REC/DUB/PLAY	0 - 127	Corresponds to pressing the A footswitch in Groove Station mode.
Looper Stop	0 - 127	This command executes the STOP command for the Looper, which is equivalent to pressing the B footswitch in Groove Station mode.
Looper Clear	0 - 127	This command executes the CLEAR command for the Looper, which is equivalent to long-pressing the B footswitch in Groove Station mode.
Looper Undo / Redo	0 - 127	This command executes the UNDO /REDO command for the Looper, which is equivalent to long-pressing the A footswitch in Groove Station mode when the number of tracks is greater or equal 2.
Looper Auto Record		Sending this command toggles on/off the Auto Record function in Groove Station mode.
Drum sync on/off	0 - 127	This command toggles Drum Machine Synchronization in Groove Station mode on/off.
Tuner enter/exit	0 - 127	Open / close the Tuner screen.
Tuner bypass/mute	0 - 127	This command toggles bypass / mute tuning for the Tuner function.
Exp Pedal	0 - 127	This corresponds to moving the EXP pedal.
CTRL mode	0 - 127	Send this command to switch between STOMPBOX and SUBPATCH in CTRL mode
Stompbox Control B	0 - 127	Send this command to switch Stompbox B in CTRL mode
Stompbox Control C	0 - 127	Send this command to switch Stompbox C in CTRL mode
Stompbox Control D	0 - 127	Send this command to switch Stompbox D in CTRL mode
Subpatch 1	0 - 127	Send this command to toggle SubPatch 1 in CTRL mode
Subpatch 2	0 - 127	Send this command to toggle SubPatch 2 in CTRL mode
Subpatch 3	0 - 127	Send this command to toggle SubPatch 3 in CTRL mode

PC mapping

This list corresponds to the preset numbers that can be controlled by PC codes from two MIDI banks (0 and 1). The individual settings can be changed by the user.

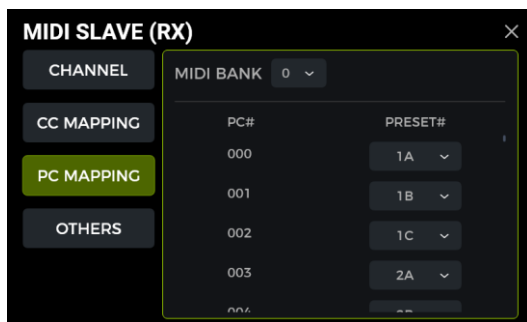

List of default factory settings:

MIDI bank	PC code	Preset No.	MIDI bank	PC code	Preset No.	MIDI bank	PC code	Preset No.	MIDI bank	PC code	Preset No.
0	0	1A	0	32	9A	0	64	17A	0	96	25A
0	1	1B	0	33	9B	0	65	17B	0	97	25B
0	2	1C	0	34	9C	0	66	17C	0	98	25C
0	3	1D	0	35	9D	0	67	17D	0	99	25D
0	4	2A	0	36	10A	0	68	18A	0	100	-
0	5	2B	0	37	10B	0	69	18B	0	101	-
0	6	2C	0	38	10C	0	70	18C	0	102	-
0	7	2D	0	39	10D	0	71	18D	0	103	-
0	8	3A	0	40	11A	0	72	19A	0	104	-
0	9	3B	0	41	11B	0	73	19B	0	105	-
0	10	3C	0	42	11C	0	74	19C	0	106	-
0	11	3D	0	43	11D	0	75	19D	0	107	-
0	12	4A	0	44	12A	0	76	20A	0	108	-
0	13	4B	0	45	12B	0	77	20B	0	109	-
0	14	4C	0	46	12C	0	78	20C	0	110	-
0	15	4D	0	47	12D	0	79	20D	0	111	-
0	16	5A	0	48	13A	0	80	21A	0	112	-
0	17	5B	0	49	13B	0	81	21B	0	113	-
0	18	5C	0	50	13C	0	82	21C	0	114	-
0	19	5D	0	51	13D	0	83	21D	0	115	-
0	20	6A	0	52	14A	0	84	22A	0	116	-
0	21	6B	0	53	14B	0	85	22B	0	117	-
0	22	6C	0	54	14C	0	86	22C	0	118	-
0	23	6D	0	55	14D	0	87	22D	0	119	-
0	24	7A	0	56	15A	0	88	23A	0	120	-
0	25	7B	0	57	15B	0	89	23B	0	121	-
0	26	7C	0	58	15C	0	90	23C	0	122	-
0	27	7D	0	59	15D	0	91	23D	0	123	-
0	28	8A	0	60	16A	0	92	24A	0	124	-
0	29	8B	0	61	16B	0	93	24B	0	125	-
0	30	8C	0	62	16C	0	94	24C	0	126	-
0	31	8D	0	63	16D	0	95	24D	0	127	-

MIDI bank	PC code	Preset No.	MIDI bank	PC code	Preset No.	MIDI bank	PC code	Preset No.	MIDI bank	PC code	Preset No.
1	0	26A	1	32	34A	1	64	42A	1	96	50A
1	1	26B	1	33	34B	1	65	42B	1	97	50B
1	2	26C	1	34	34C	1	66	42C	1	98	50C
1	3	26D	1	35	34D	1	67	42D	1	99	50D
1	4	27A	1	36	35A	1	68	43A	1	100	-
1	5	27B	1	37	35B	1	69	43B	1	101	-
1	6	27C	1	38	35C	1	70	43C	1	102	-
1	7	27D	1	39	35D	1	71	43D	1	103	-
1	8	28A	1	40	36A	1	72	44A	1	104	-
1	9	28B	1	41	36B	1	73	44B	1	105	-
1	10	28C	1	42	36C	1	74	44C	1	106	-
1	11	28D	1	43	36D	1	75	44D	1	107	-
1	12	29A	1	44	37A	1	76	45A	1	108	-
1	13	29B	1	45	37B	1	77	45B	1	109	-
1	14	29C	1	46	37C	1	78	45C	1	110	-
1	15	29D	1	47	37D	1	79	45D	1	111	-
1	16	30A	1	48	38A	1	80	46A	1	112	-
1	17	30B	1	49	38B	1	81	46B	1	113	-
1	18	30C	1	50	38C	1	82	46C	1	114	-
1	19	30D	1	51	38D	1	83	46D	1	115	-
1	20	31A	1	52	39A	1	84	47A	1	116	-
1	21	31B	1	53	39B	1	85	47B	1	117	-
1	22	31C	1	54	39C	1	86	47C	1	118	-
1	23	31D	1	55	39D	1	87	47D	1	119	-
1	24	32A	1	56	40A	1	88	48A	1	120	-
1	25	32B	1	57	40B	1	89	48B	1	121	-
1	26	32C	1	58	40C	1	90	48C	1	122	-
1	27	32D	1	59	40D	1	91	48D	1	123	-
1	28	33A	1	60	41A	1	92	49A	1	124	-
1	29	33B	1	61	41B	1	93	49B	1	125	-
1	30	33C	1	62	41C	1	94	49C	1	126	-
1	31	33D	1	63	41D	1	95	49D	1	127	-

Other settings

Use this page to activate/disable MIDI CLOCK SYNC for incoming MIDI commands and to activate/disable USB MIDI.

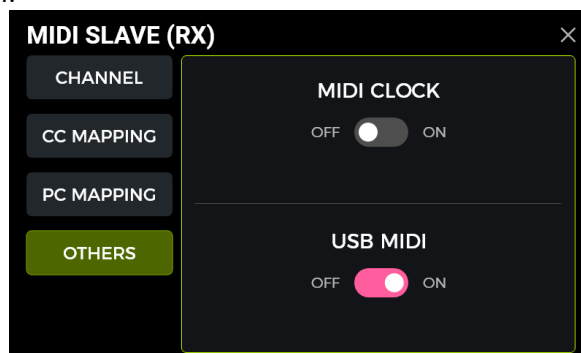

MIDI Clock: When active, tempo-based features of the main Edit View will be synchronized to the MIDI clock commands sent by the external device.

USB MIDI: Enable this feature to receive MIDI commands from a computer through the USB-C interface.

GS1000 as controlling device

To configure the GS1000 as a MIDI controller, press the SETTINGS button, scroll down to MIDI, select "Controller" and click "Settings" to enter the configuration page. The following options are provided:

MIDI Channel

Click CHANNEL and select the MIDI channel the GS1000 will use to send commands. The factory default is Channel 1.

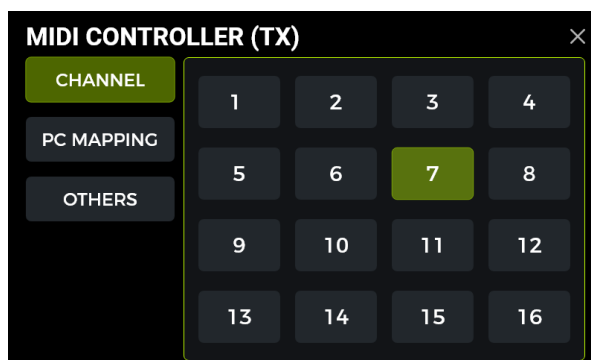

PC mapping

This list corresponds to the PC codes in two MIDI banks (0 and 1) that the GS1000 can send. The individual settings can be changed by the user.

After switching to a preset, the GS1000 will send CC0 (MIDI bank information) + the PC command to the receiving device.

Preset No.	MIDI bank	PC command	Preset No.	MIDI bank	PC command	Preset No.	MIDI bank	PC command	Preset No.	MIDI bank	PC command
1A	0	0	9A	0	32	17A	0	64	25A	0	96
1B	0	1	9B	0	33	17B	0	65	25B	0	97
1C	0	2	9C	0	34	17C	0	66	25C	0	98
1D	0	3	9D	0	35	17D	0	67	25D	0	99
2A	0	4	10A	0	36	18A	0	68	-	-	-
2B	0	5	10B	0	37	18B	0	69	-	-	-
2C	0	6	10C	0	38	18C	0	70	-	-	-
2D	0	7	10D	0	39	18D	0	71	-	-	-
3A	0	8	11A	0	40	19A	0	72	-	-	-
3B	0	9	11B	0	41	19B	0	73	-	-	-
3C	0	10	11C	0	42	19C	0	74	-	-	-
3D	0	11	11D	0	43	19D	0	75	-	-	-
4A	0	12	12A	0	44	20A	0	76	-	-	-
4B	0	13	12B	0	45	20B	0	77	-	-	-
4C	0	14	12C	0	46	20C	0	78	-	-	-
4D	0	15	12D	0	47	20D	0	79	-	-	-
5A	0	16	13A	0	48	21A	0	80	-	-	-
5B	0	17	13B	0	49	21B	0	81	-	-	-
5C	0	18	13C	0	50	21C	0	82	-	-	-
5D	0	19	13D	0	51	21D	0	83	-	-	-
6A	0	20	14A	0	52	22A	0	84	-	-	-
6B	0	21	14B	0	53	22B	0	85	-	-	-
6C	0	22	14C	0	54	22C	0	86	-	-	-
6D	0	23	14D	0	55	22D	0	87	-	-	-
7A	0	24	15A	0	56	23A	0	88	-	-	-
7B	0	25	15B	0	57	23B	0	89	-	-	-
7C	0	26	15C	0	58	23C	0	90	-	-	-
7D	0	27	15D	0	59	23D	0	91	-	-	-
8A	0	28	16A	0	60	24A	0	92	-	-	-
8B	0	29	16B	0	61	24B	0	93	-	-	-
8C	0	30	16C	0	62	24C	0	94	-	-	-
8D	0	31	16D	0	63	24D	0	95	-	-	-

Preset No.	MIDI bank	PC command	Preset No.	MIDI bank	PC command	Preset No.	MIDI bank	PC command	Preset No.	MIDI bank	PC command
26A	1	0	34A	1	32	42A	1	64	50A	1	96
26B	1	1	34B	1	33	42B	1	65	50B	1	97
26C	1	2	34C	1	34	42C	1	66	50C	1	98
26D	1	3	34D	1	35	42D	1	67	50D	1	99
27A	1	4	35A	1	36	43A	1	68	-	-	-
27B	1	5	35B	1	37	43B	1	69	-	-	-
27C	1	6	35C	1	38	43C	1	70	-	-	-
27D	1	7	35D	1	39	43D	1	71	-	-	-
28A	1	8	36A	1	40	44A	1	72	-	-	-
28B	1	9	36B	1	41	44B	1	73	-	-	-
28C	1	10	36C	1	42	44C	1	74	-	-	-
28D	1	11	36D	1	43	44D	1	75	-	-	-
29A	1	12	37A	1	44	45A	1	76	-	-	-
29B	1	13	37B	1	45	45B	1	77	-	-	-
29C	1	14	37C	1	46	45C	1	78	-	-	-
29D	1	15	37D	1	47	45D	1	79	-	-	-
30A	1	16	38A	1	48	46A	1	80	-	-	-
30B	1	17	38B	1	49	46B	1	81	-	-	-
30C	1	18	38C	1	50	46C	1	82	-	-	-
30D	1	19	38D	1	51	46D	1	83	-	-	-
31A	1	20	39A	1	52	47A	1	84	-	-	-
31B	1	21	39B	1	53	47B	1	85	-	-	-
31C	1	22	39C	1	54	47C	1	86	-	-	-
31D	1	23	39D	1	55	47D	1	87	-	-	-
32A	1	24	40A	1	56	48A	1	88	-	-	-
32B	1	25	40B	1	57	48B	1	89	-	-	-
32C	1	26	40C	1	58	48C	1	90	-	-	-
32D	1	27	40D	1	59	48D	1	91	-	-	-
33A	1	28	41A	1	60	49A	1	92	-	-	-
33B	1	29	41B	1	61	49B	1	93	-	-	-
33C	1	30	41C	1	62	49C	1	94	-	-	-
33D	1	31	41D	1	63	49D	1	95	-	-	-

Other settings

Use this page to activate/disable MIDI CLOCK SYNC for outgoing MIDI commands and to activate/disable USB MIDI and the transmission of the MIDI BANK command.

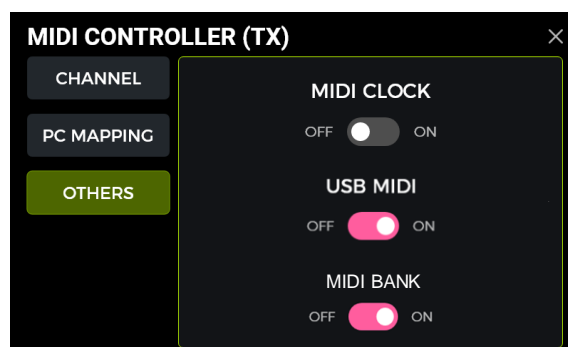

MIDI Clock: When active, MIDI clock commands are sent out based on the GS1000's current BPM tempo.

USB MIDI: Enable this feature to send MIDI commands through the USB-C interface.

MIDI BANK: When the GS1000 is set up as a controller and this option is turned on, a MIDI BANK CC code will be sent along with the PC code. When you are using the GS1000's PC code to control other devices, you can try to turn off this switch if you encounter a situation in which the controlled device fails to respond.

F4 WIRELESS FOOTSWITCH

For extended control options, the GS1000 supports a connection to a MOOER F4 wireless footswitch (to be purchased separately).

Please consult the manual for the F4 footswitch for battery specs and charging requirements.

The GS1000 can only be connected to one wireless footswitch at a time.

Before using the footswitch for the first time (or after a factory reset), please follow the steps below to pair the footswitch with the GS1000:

- Switch the F4 footswitch on, press and hold footswitches A and C simultaneously to enter pairing mode (LED blinking).
- Click the Footswitch icon in the main screen of the GS1000.
- Click START PAIRING.
- When the pairing is successful, the GS1000 shows "Unpair" in the top right corner and the display on the F4 footswitch shows "On".
- Once paired, the wireless footswitch will automatically connect to the GS1000 each time both devices are turned on and within range of each other.

Note: You can click "Unpair" to disconnect the F4 Footswitch.

Configuring the wireless footswitch

After the F4 is paired, press the wireless footswitch icon below the effect chain, or enter the GLOBAL SETTING menu to configure the wireless footswitch. The GLOBAL SETTINGS Menu also provides an option to turn the F4 footswitch on or off, without unpairing it.

The wireless footswitch menu opens where you can select the functions you wish to control with each footswitch by clicking the field below each footswitch and selecting a function from the list.

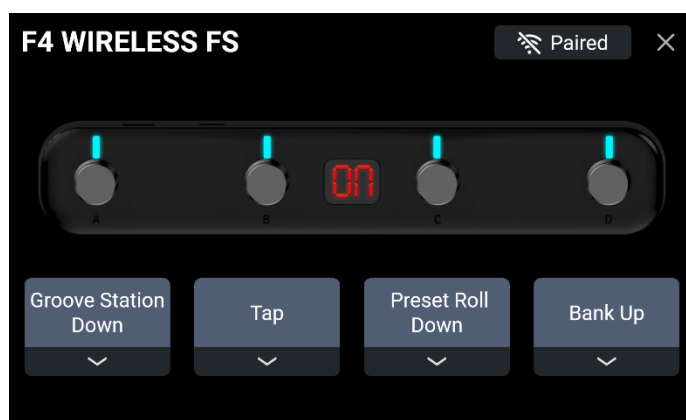

Wireless footswitch settings menu

Available functions for the wireless footswitch

The following functions can be assigned to each footswitch of the F4:

Num.	Function	Description
1	Empty	no function
2	Preset A	Switch to preset A of the current bank.
3	Preset B	Switch to preset B of the current bank.
4	Preset C	Switch to preset C of the current bank.
5	Preset D	Switch to preset D of the current bank.
6	Preset Up	Switch Up between presets.
7	Preset Down	Switch Down between presets.
8	Bank Up	Switch Up between preset banks.
9	Bank Down	Switch Down between preset banks.
10	Tuner	Enter the TUNER mode, the wireless footswitch LED will flash slowly. Press any footswitch to quit.
11	TAP	TAP function: press the footswitch several times to set the tempo. The wireless footswitch LED will flash to indicate the selected tempo.
12	CTRL Mode	Switches between STOPMBOX and SUBPATCH in CTRL Mode.
13	Stompbox B	Corresponds to the function of Stompbox B in CTRL mode.
14	Stompbox C	Corresponds to the function of Stompbox C in CTRL mode.
15	Stompbox D	Corresponds to the function of Stompbox D in CTRL mode.
16	LOOPER REC/PLAY/DUB	Operates the recording/playback/overdubbing functions for phrase loops in GROOVE STATION mode.
17	LOOPER STOP	Operates the STOP function for phrase loops in GROOVE STATION mode.
18	LOOPER DELETE	Operates the DELETE function for phrase loops in GROOVE STATION mode.
19	LOOPER UNDO/REDO	Operates the UNDO/REDO function for phrase loops in GROOVE STATION mode.
20	DRUM TAP	Enters the TAP Tempo for the Drum Machine rhythm.
21	DRUM ON/OFF	Starts/Stops the DRUM MACHINE.
22	SUBPATCH 1	Corresponds to the SubPatch 1 function in CTRL mode
23	SUBPATCH 2	Corresponds to the SubPatch 2 function in CTRL mode
24	SUBPATCH 3	Corresponds to the SubPatch 3 function in CTRL mode

This means that, depending on the functions you have assigned, you can use the wireless footswitch at any time to individually activate/deactivate the selected function without actually opening the respective mode.

OTHER GLOBAL SETTINGS

The GLOBAL SETTINGS screen can be accessed by clicking the **settings icon** at the bottom of the Edit View. Other global settings can be accessed by clicking the **input or output indicators** on the upper edge of the Edit View.

Return to the previous screen by clicking the "X" in the upper right corner or by pressing the HOME button.

Global input settings

Click the input level indicator in the Edit View to open the global input settings screen.

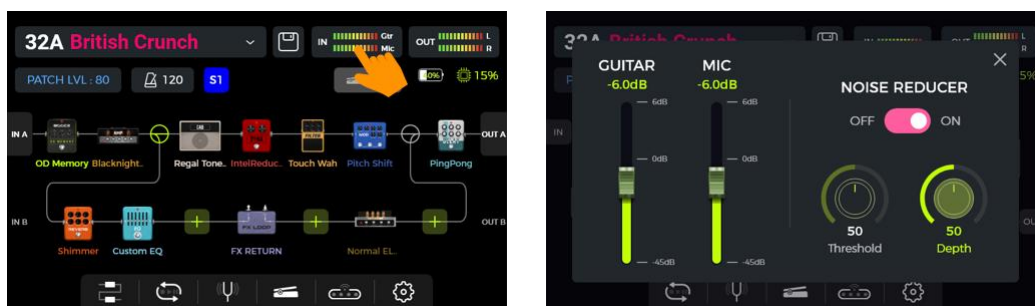

The **input gain** for the guitar and microphone inputs can be adjusted on the left side of the pop-up window. Use it to compensate for strong signals from instrument pickups with different output characteristics or from signal amplifying pedals (boost, overdrive, distortion ...) in front of the GS1000.

You can get visual confirmation of the input level by watching the **input level indication bars** on the screen. A green indication is OK, a red indication means that the input signal is clipping i.e. distorted.

Note: Adjusting the global input level can prevent input distortion caused by exceedingly powerful input signals.

Use the global **NOISE REDUCER** feature to adjust the noise floor according to the requirements of different environments. This can eliminate the need for tedious preset by preset adjustments.

Global output settings

Click the output indicator in the Edit View to open the global output settings screen.

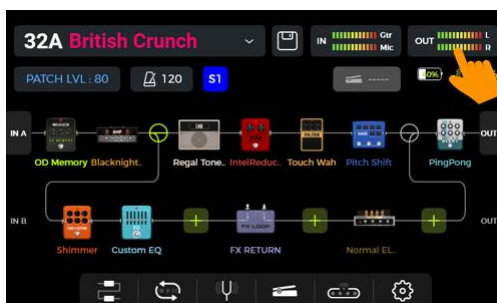

You can get visual confirmation of the output level at the end of the effect chain by watching the **output level indication bars** on the screen. A green indication is OK, a red indication means that the output signal is clipping i.e. distorted.

1. Global output levels

You can use this page to set the output volume for each output interface individually, including the 1/4" output ports, the headphone jack and the USB digital recording output.

Use these settings to establish the relative volume ratio between the different outputs.

The **MASTER knob** on the pedal will increase/decrease all outputs at the same time, but will maintain the ratios established here.



Select an output and slide the faders or rotate the SELECT knob for fine-tuning.

The **chain icon** below each group of faders is a left/right channel synchronization switch. When the icon is lit, the left and right channels of the respective group are synchronized. When the icon is off, the left and right channels of the group can be set independently. Click the chain icon to toggle the status.

Clicking on the **top of the 1/4" output** sliders switches between **balanced** and **unbalanced** output match the current connection requirements. The sliders will be shown in orange to indicate balanced output.

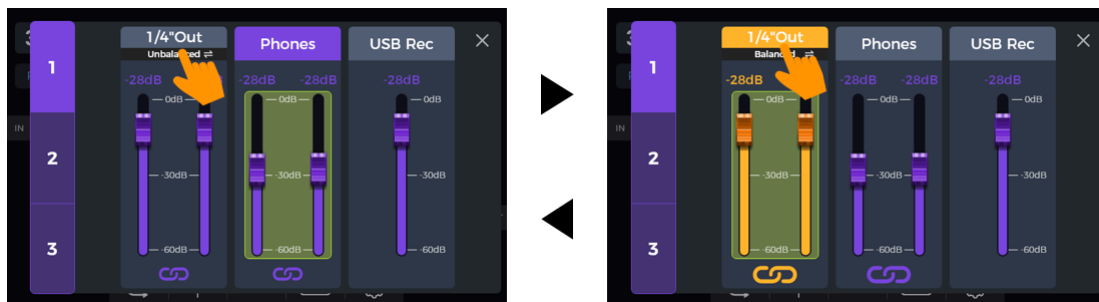

2. Global equalization adjustment

Click the second page to access the GLOBAL EQ screen. Use this feature to quickly adjust the sound to the requirements of different venues and the frequency response characteristics of different amplification equipment. This is the best way to avoid tedious preset by preset adjustments.

The Global EQ needs to be turned ON to be effective.



3. Other function switches

Click the third page to set global function switches.

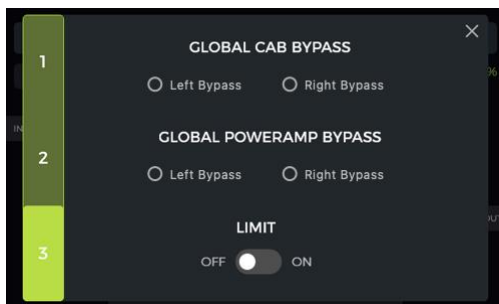

GLOBAL CAB BYPASS: Global bypass for all cab simulation effects for the outputs.

GLOBAL POWER AMP BYPASS: Global bypass for all power amp simulation effects for the outputs.

These settings are applied to **all presets** and may be necessary for certain connection scenarios where different outputs with or without cabinet simulation (or amp simulation) are used.

Note: After activating global CAB or POWERAMP bypass, you should avoid loading mono modules (models other than modulation, delay or reverb effects in stereo) behind the CAB or POWERAMP. If you load mono modules you will mix and superimpose left and right signals, and you cannot achieve the desired separate bypass effects for the left and right channels.

LIMIT: Enable this switch to avoid digital signal clipping caused by the volume gain of an internal module exceeding the maximum dynamic range.

Screen Brightness

In some situations, you may want to adjust the screen brightness to adapt to different lighting environments, or to extend the battery life of the battery version.

Click the **Settings icon** on the main view to open the settings and drag the **BRIGHTNESS** slider or rotate the **SELECT knob** to adjust screen brightness.

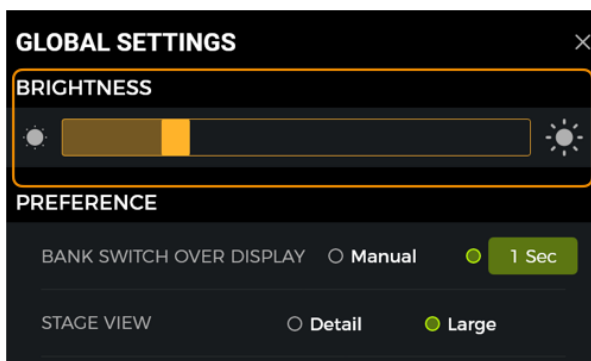

Lighting

This item allows you to set the ambient lighting of the GS1000, including the function, color and mode of the light bars on the top and bottom surfaces.

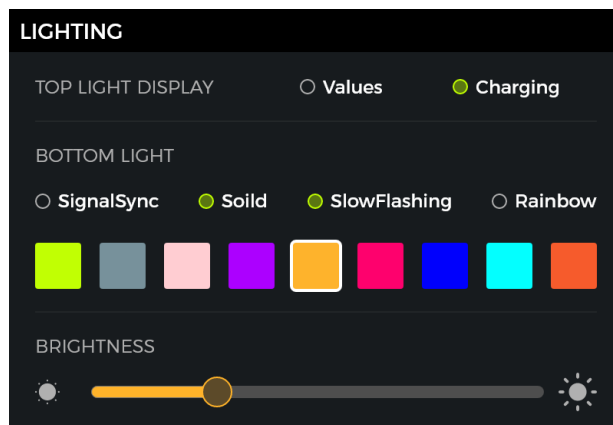

Top light bar

If **Values** is selected, the top light bar will temporarily display the percentage of the value while a parameter is adjusted.

With **Charging** selected (GS1000 Li only), the top light bar will show a dynamic effect when the power is off and charging.

Bottom ambient lighting

SignalSync: Dynamic flashing depending on the output signal strength (single color choice).

Solid: Constant single color light.

SlowFlashing: Slow flashing cycle in the selected color (single color choice).

Rainbow: Dynamic flow sequence in the selected colors (multiple colors can be selected).

After selecting a mode, click the color block(s) to select the ambient light color.

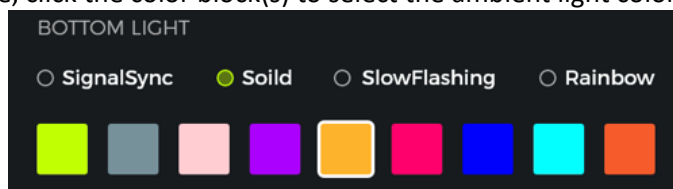

Move the slider to adjust the brightness of the bottom ambient light.

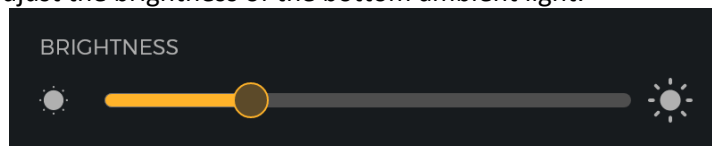

Preference section

This section allows adjustment of some personal preferences.

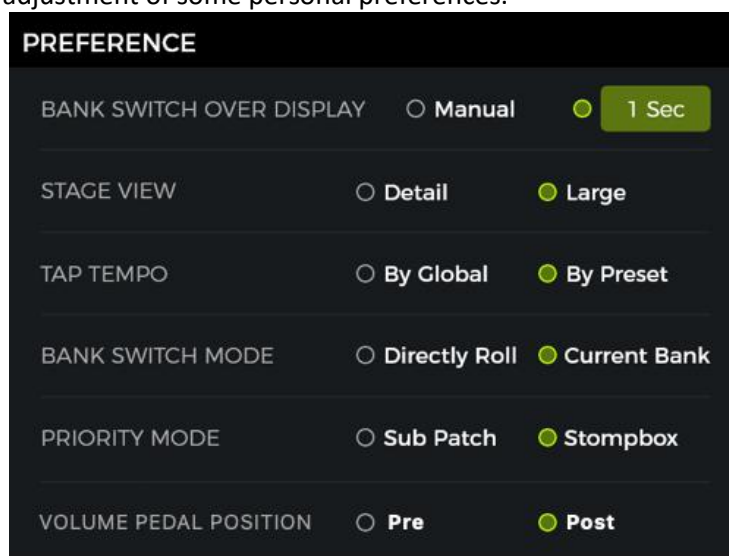

BANK SWITCH OVER DISPLAY

This setting controls how the **bank selection view** switches back to the main view after the A+B or C+D footswitches were pressed to select a different preset bank.

If set to "**Manual**", one of the **A/B/C/D** footswitches must be pressed (and therefore a preset within the bank selected) before the screen switches back to the main interface.

If a **time** is selected (open a drop-down menu by clicking the time field), the bank selection screen will be closed automatically after this time has elapsed. The previously used preset will still be active in this case. To change presets in the bank selection screen, you will have to tap one of the **A/B/C/D** footswitches before the selected time elapses.

STAGE VIEW

Use this setting to select one of two Stage View types: "Detailed Display" or "Large Display".



Detailed display

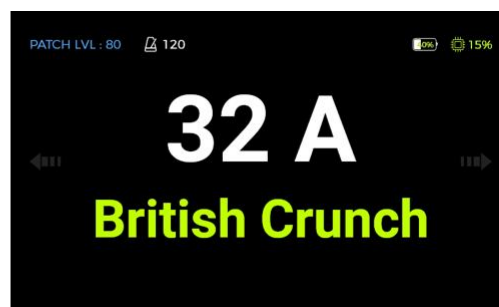

Large display

TAP TEMPO

This setting controls how the tap tempo input is used within the GS1000. When set to "**Global**", all presets are effected by a tap tempo input, when set to "**Preset**" every individual preset can have its own tap tempo input. You can also click the "Metronome" icon in Edit View to access the same settings. (See [BPM tempo](#))

BANK SWITCH MODE

Use this option to select between two Bank switching modes:

Directly Roll means that when you press Bank down (A+B) or Bank up (C+D), the bank will change directly one down or up. Pressing one of the A/B/C/D footswitches will then open the preset in this newly selected bank.

Current Bank means that when you press Bank down (A+B) or Bank up (C+D), the view will switch to the bank preview display without directly switching to any other bank, i.e. remaining in the current bank. You can then select another bank by stepping on A+B or C+D again.

PRIORITY MODE

Use this setting to determine the active sub-mode when you access the CTRL mode by stepping on the footswitch for the active preset.

When set to **SubPatch**, the **SUBPATCH** mode will be active upon activation of the CTRL mode, when set to **Stompbox**, the **STOMPBOX** mode will be active.

Note that this setting is linked to the **Priority Mode** setting in the CTRL view. (See [CTRL mode](#)).

VOLUME PEDAL POSITION

Use this setting to determine the position of the volume pedal (external expression pedal used as volume pedal) with respect to the effects chain within the GS1000.

When set to **Pre**, the volume pedal will be placed at the very front of the effects chain.

Using this setting can maximize the preservation of the trails of some of your effect like delay and reverb in scenarios where the volume pedal is used.

When set to **Post**, the volume pedal will be placed at the very end of the effects chain.

Using this setting, the volume pedal will act as a master volume and the signal can be completely muted with the pedal moved to its minimum value.

The default for this setting option is **Post**.

MIDI

See [MIDI CONFIGURATION](#).

Bluetooth

Turn Bluetooth on/off in order to use the GS1000 with the Mooer GE Cloud App or to play audio from a mobile device through the GS1000. See [BLUETOOTH AUDIO](#).

F4 Wireless Footswitch

Turn the F4 Wireless Footswitch on/off and open the footswitch settings view. (See [F4 WIRELESS FOOTSWITCH](#))

USB Audio

See [USB Digital Audio](#).

Spill-Over (Effect Trails)

The GS1000 supports the trail hold function for delay and reverb effects.

Under some conditions, the natural decay of delay repeats or reverb echoes can be maintained when a corresponding module in is toggled on/off within a preset or when a different preset is activated:

Trails when modules are switched ON/OFF within a preset:

This type of ON/OFF switching while playing is usually accomplished using the CTRL mode or a MIDI command from an external controller (see [CTRL Mode](#) or [MIDI](#).)

- Open the parameter editing interface of the delay or reverb module in the preset.
- Find the "Trail" parameter and activate it.

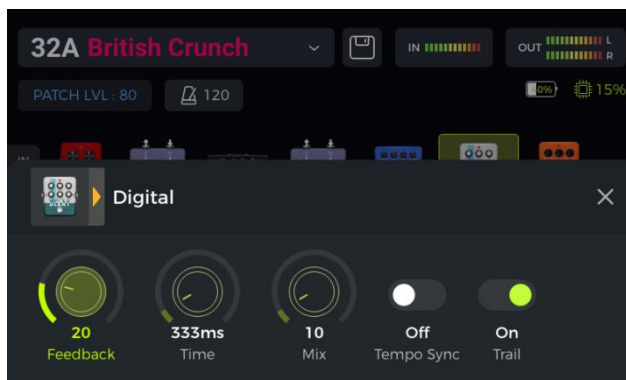

Trails when switching presets:

This type of switching is accomplished by using the A, B, C or D footswitches or external MIDI commands to change presets.

- Find SPILL-OVER in the GLOBAL SETTINGS and activate it.



- Copy a target preset and save it to the position you want to switch to.
- In the new preset position, you can change the module switching status, or adjust different parameter settings according to the sound requirements.
- After completing these settings, you can switch between these two presets and maintain the natural decay of the delay and reverb tails.

Note: The trails feature does not support switching between two different effect chains or selecting different delay and reverb effect models.

Language Selection

The GS1000 supports menus in Chinese and in English.



Factory reset

If required, settings can be partially or fully restored to factory values.

Open the GLOBAL SETTINGS screen, scroll down to FACTORY RESET and select the settings you want to re-set. Click **RESET** to confirm.

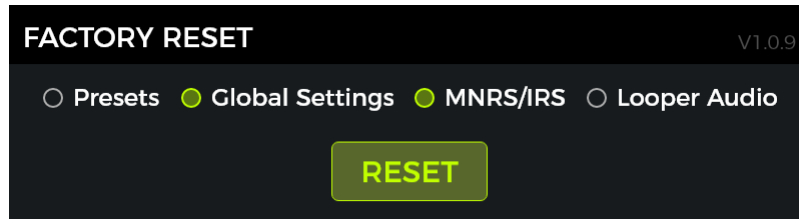

- **Presets:** Only the preset data will be restored to factory settings. All sounds you may have created or imported after purchasing the GS1000 will be deleted.
- **Global Settings:** Personalized settings such as screen brightness, preference settings, MIDI mappings, USB audio settings, trails and language settings will be restored to factory defaults.
- **MNRS/IRS:** All imported MNRS samples as well as GIR and IR sample data will be deleted.
- **Looper audio:** All audio recordings made with the Looper function will be deleted.

The Factory Reset section also shows the currently installed **Firmware** version above the Reset options.

MOOER STUDIO Software

MOOER STUDIO is the computer editor software for MOOER intelligent series products. Users can edit effect module parameters, re-arrange the effect chain and also manage data (firmware updates, upload/download presets, import of GNR/GIR/IR files, backup/restore settings, looper audio export/import).

Software download

Visit the official MOOER AUDIO website (www.mooeraudio.com) and navigate to the DOWNLOAD area. Find the "GS1000" page, download the appropriate installation program for your operating system (Windows or Mac) and install it.

System requirements:

- Windows-Win10 or above
- Mac OS-10.11 or above

Establishing the connection

After the installation is complete, please use the supplied USB cable to connect your GS1000 to the computer, open the MOOER STUDIO software, and click on the CONNECT button to establish the connection between the software and the device.

Data Manager interface

The screenshot shows the MOOER STUDIO software interface with several callout boxes:

- Device online information:** Displays connected device, connection status, and firmware version. Click the switch to connect or disconnect.
- Function selection area:** Select the function you want to use: Firmware updates, 3rd party GIR/IR/GNR/MNRS file import, or backup/restore all settings on your device.
- Account Login:** Sign up for a login account to use data from the Mooer cloud.
- Software function area:** Switch between editing functions and data management functions.
- Language selection:** Click the drop-down box to select the language. This setting adjusts the language of both the software and the connected device.
- Control area:** Open a control menu depending on the selection on the left side.

Firmware update

You can find the current **firmware version** of your GS1000 by scrolling down to FACTORY RESET in the SYSTEM menu. The firmware version is shown above the reset options.

- Download the editor software with the new firmware version, install it, and connect your GS1000 to your computer.
- Find the DEVICE UPDATE button in the function selection area on the left side.
- Click on UPDATE in the function operation area on the right side to confirm. The device will be booted to update mode.
- Wait for a few minutes until the update is complete.

Note: To avoid unexpected issues, please do not disconnect the USB connection or the power supply during the update process. Avoid using USB HUB connections and connect the USB cable directly to a USB port on computer.

Third party IR import

IR files are based on impulse response technology for cabinet simulation models. The standard format for IR files is "wav". Follow these steps to import IR files:

- Obtain an IR file from a third party and save it on your computer.
- Select the third-party IR (3rd IRs) option on the left side of the software interface.
- Select the position for the file in the list. The list corresponds to the GIR list in the CAB module in the GS1000.
- Click "+" to select a file on your computer and import it into the GS1000.
- Click OK to import the selected IR file.



MNRS sampling file management

MNRS sample files in the GS1000 consist of the following four types:

- Drive pedal sample (GNR)
- Preamp sample (GNR)
- Full amplifier sample (GNR)
- Speaker cabinet sample (GIR)

The CAB cabinet sample is in 'GIR' format, the other three are in 'GNR' format.



You can use the MOOER STUDIO software to manage the data on your device or download user-shared samples from the cloud.

Local data management

Select "MNRS" in the selection area on the left and select "DEVICE" in the control area on the right. The four sampling type lists show the corresponding GNR/GIR files for the respective models in your device.



Use this menu to load, delete and upload local files.

- Click the  icon to delete the file data at the selected location.
- Click the  icon to upload the file to the cloud.
- Click the  icon to load a sample file that has been saved on your computer into your device.

Note: To save sample files locally, you can register and download files at www.moerstudio.com.

Data download from the cloud

The GS1000 editing software supports download of files from the MOOER data cloud.

To use the cloud data function, please register and log in first.

Click "CLOUD" in the control area, and select a corresponding sample type list to find files you want to use on your device.

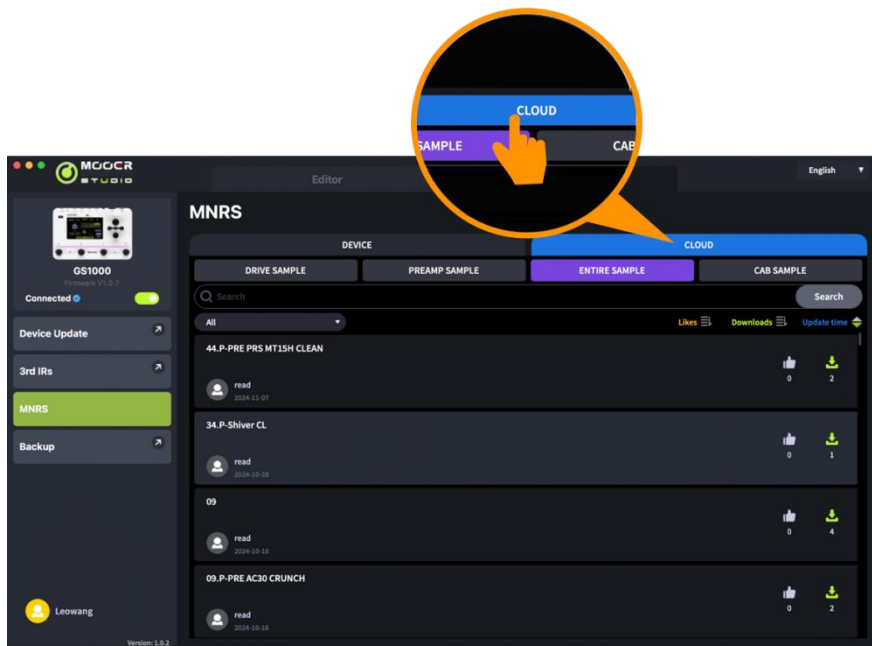

Data backup

The backup feature allows the user to make a complete backup of the device's data, including preset patches, loaded GNR/GIR/IR files and global settings. You can use this feature to quickly recall settings for different usage situations and venues.

- Select **Backup** on the left side of the MOOER Studio software interface to open a list of previous backups.
- Click on **Backup** and wait until the backup procedure finishes. Your new backup file will be listed with a date and time stamp.
- If you need to restore the data, find the corresponding backup record and click **Restore** to quickly recall a backup file into your device.

Preset Editor interface



Preset management

- In the **Presets List** area, you can click to select a preset or drag a preset to a different position to change the order of presets.
- **Right-click on a preset** to open a window where you can rename/copy/paste/import/export the preset. The exported preset file will be saved into the target file folder. Click on the folder icon above the preset list to open the default folder.
- You can right-click on a preset file to **import** it, or drag the file to the preset patch area, and click on CONFIRM to import the file into the device.

Preset editing

The effect modules contained in a preset can be found in the **effect chain area**, where you can see the order and the On/Off status of the individual effect modules.

- **Parameter adjustment:** Click on a module, the parameter window will be shown where you can directly adjust parameters in real time.
- **Adding an effect module:** Click on a "+" icon to add a module to the effect chain. Select an effect type and confirm.
- **Changing the order:** Select an effect module, hold it and drag it to the desired position.
- **Saving changes:** When any changes have been made in a preset patch, the saving icon in the preset saving area will flash as a reminder. During saving you can set the name and color of a preset. After you confirm saving, all parameter changes will be saved.

Effect chain editing

Click the effect chain type icon in the upper right corner of the software window to quickly change chain type settings.

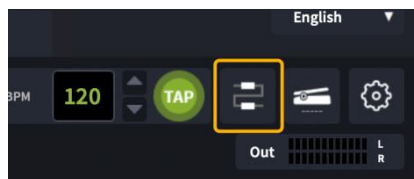

Drag a node to move it and change the configuration of the effect chain.

Click on the node icons (including input/output nodes and split/mix nodes) to adjust the parameters for the node.



Module parameter settings

The area below the effect chain shows the settings for the selected module.

Use this area to activate / deactivate the module with the on/off switch symbol, change the effect model, select a different effect type for the model and adjust the parameters for the selected module.

Expression pedal settings

You can find the expression pedal area at the bottom of parameter section under each assignable parameter.

You can assign selected parameters to the expression pedal by clicking the activation button, and you can also set minimum and maximum values.

Click on the **expression pedal icon** at the top-right corner to see all parameters controlled by the expression pedal. You can edit them directly.

Note: The changes in the settings of the expression pedal must be saved manually into the preset.

Preset volume level and BPM settings

You can adjust the preset volume level and the BPM setting in the control area. You can use the TAP function for BPM setting: click the TAP icon several times to input a tempo.

When the tempo parameters of a Delay module or some of the Modulation modules are set to SYNC with TAP, they will all sync with the TAP value you have set.

Note: In the GLOBAL SETTINGS menu, you can set the TAP tempo as global TAP input or as TAP input for the current Preset.

Input & output settings

Click on the Input or Output level fields, and drag the bar in the pop-up window to adjust the input/output volume levels.

- In the input setting menu, you can adjust the input volume levels and global noise gate settings.
- In the output setting menu, you can adjust the volume level for each output channel, the global EQ as well as global settings for Cab and Power Amp simulations.

Global Settings

Click on the SETTINGS icon to open the menu. Use this menu to adjust settings for the screen brightness, preferences, effect trails, USB Audio and factory reset.

MOOER CLOUD APP

The MOOER CLOUD APP is a mobile data management application supporting devices of the MOOER Intelligent Series. Using a Bluetooth connection on your smart phone, you can upload or download presets and import GNR/GIR sampling data from the cloud.

App download

IOS users can download the software by searching for MOOER CLOUD in the App Store.

Android users can download the software by searching for it in the App Store (Google Play etc.) or by visiting the download area of the official MOOER website.

System Requirements

IOS 11 or above

Android 5.0 or above

Connection and Login

- Make sure Bluetooth is active on your Smartphone and on your GS1000 (SYSTEM menu).
- Activate Location on your Smartphone.
- Open the app, swipe the picture left or right until the image of the GS1000 is displayed and click the CONNECT switch. Click the device name in the pop-up menu to connect.
- Login or register an account. Users who already have a MOOER STUDIO account do not need to register again.
- After connecting and logging in, you can open the MNRS section of the app to download sample files for Amp models or CAB models from the cloud directly into your GS1000. You can find and use these models in the GNR sections (AMP module) or GIR sections (CAB module) of your device.
- Open the PRESET section of the app to find the Presets on your GS1000 listed under "My Device". You can tap the Upload button to load your Preset (including a description and a classification) into the cloud for other users to download.
- The "Clouds" list in the PRESET section shows Factory and User presets to download into your GS1000. A filter feature makes selection easier. Selecting a preset shows its effect chain configuration. You can then tap on "Download", select a storage slot on your device and load it directly into your GS1000. The downloaded preset will then be opened on your device for immediate testing.

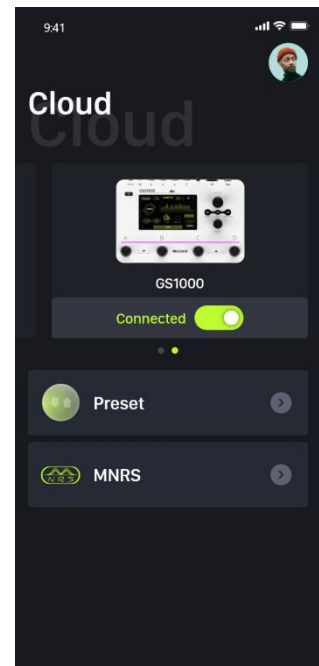

The GS1000 does not start

- Ensure that the original power adapter is connected.
- GS1000 Li (battery-powered version): Make sure the battery still has sufficient charge to meet the power demands during boot-up. Connect the original adapter before trying to start the device.

No sound after startup

- Check that the MASTER volume knob on the panel is turned to the proper position.
- Navigate to INPUT LEVEL settings to make sure the input gain sliders are in the proper position.
- Navigate to OUTPUT LEVEL settings to make sure the output sliders are in the proper positions.
- Check that the preset volume is properly set.
- If an external expression pedal is connected: check if the pedal is in volume mode, and move the pedal rocker to a different position.
- Check that USB Audio in the SYSTEM settings menu is in "Normal" mode. "Re-AMP" mode will switch the source of the signal input to USB and cause the normal input to be silent.

Low frequency hum

- Please use signal cables with good shielding.
- Change the usage environment or the time of usage to determine if the noise is caused by interference from sources in the environment.
- Keep a distance from computers, motors, fans and other electrical appliances to reduce electromagnetic interference.

SPECIFICATIONS

Effects

Number of module types	11
Total number of effect models	350
Preset storage slots	200

Impulse response

Supported formats	WAV
Sampling rate	44.1 kHz
Sampling accuracy	24 bit
Number of sample points	Up to 2048 sampling points

EXP jack

Interface type	1 x 1/4" TRS stereo connector
Input impedance	supports 10 - 100 kOhm expression pedals

Inputs

Guitar input jack

Interface type	1 x 1/4" unbalanced mono input connector
Input impedance	1 MOhm
Maximum input level	10 dBu

Microphone input jack

Interface type	1 x 1/4" & XLR combo-connector
Input impedance	2.4 kOhm
Maximum input level	10 dBu (1/4")
Microphone gain	60 dB

RETURN jack

Interface type	1 x 1/4" unbalanced stereo input connector
Input impedance	1 MOhm
Maximum input level	10 dBu

Audio Analog-to-Digital Converter

Sampling rate	44.1 kHz
Sampling accuracy	24 bit
Dynamic range	114 dB
Frequency response	20 Hz - 20 kHz, +0 / -1 dB

Outputs

OUTPUT jacks

Interface type	2 x 1/4" balanced TRS output jacks
Output impedance	600 Ohm
Maximum output level	16 dBu

SEND jack

Interface type	1 x 1/4" unbalanced TRS output jack
Output Impedance	510 Ohm
Maximum output level	12 dBu

PHONES jack

Interface type	1 x 1/8" unbalanced stereo output connector
Output impedance	6 Ohm
Maximum output level	16 dBu

Audio DAC

Dynamic range	115 dB
Frequency response	20 Hz - 20 kHz, +0 / -1 dB
Signal-to-noise ratio	115 dB

Misc

MIDI interface

MIDI IN or MIDI OUT	1 x 1/8" MIDI connector
---------------------	-------------------------

USB port

Interface type	TYPE-C connector
USB Audio	USB 2.0, 2-in-2 out, 44.1 - 192 kHz, 24 bit

EXP port

Interface type	1 x 1/4" TRS connector for external pedal (for 10 - 100 kOhm TRS expression pedals)
----------------	--

General

Power Supply

GS1000: DC 9 V, 2 A, negative center
GS1000 Li: DC 9 V, 3 A, negative center

Battery (GS1000 Li)

Li-ion, rechargeable, 4750 mAh, 35.15 Wh, 7.4 V

Battery life (GS1000 Li)

Approx. 6 hours (25°C, 50% screen and ambient light brightness)

Charging time (GS1000 Li)

Approx. 2.5 h (using original adapter, device turned off)

Dimensions

240 mm × 161 mm × 67 mm (LxWxH)

Weight

GS1000: 1.23 kg / GS1000 Li: 1.37 kg

Accessories

Power Adapter, USB Cable, MIDI Adapter Cable, Quick Guide

Disclaimer: Parameter updates will not be notified separately.

ANNEX 1: EFFECT DESCRIPTIONS

Dynamic modules

Effect Description		
No.	Model name	Description
1	S-Comp	Dual-parameter adjustable compressor.
2	Red Comp	Dual-parameter compressor.
3	Yellow Comp	Based on MOOER® YELLOW COMP compressor with four parameters.
4	Blue Comp	Compressor based on MOOER® BLUE COMP with four parameters.
5	Boost Comp	Compressor / Booster effect with three-band equalization.
6	L-Studio Comp	Vintage analog studio compressor.
7	Deluxe Comp	Modern analog studio compressor.
8	3-Band Comp	80s studio digital compressor.
9	Limit	Dual-parameter limiter.
10	Blood Comp	Three parameter compressor with adjustable blend ratio.
11	Noise Killer	Hard noise gate based on the Mooer® Micro Noise Killer. The effect solves noise issues quickly and efficiently with simple threshold adjustments.
12	Intel Reducer	Unlike conventional noise gates, this works by separating the conventional signal from the white noise in the signal and eliminating the white noise to achieve noise reduction while maintaining natural decay. This module is recommended for use before distortion effects or speaker simulation.
13	Noise Gate	Four parameter studio noise gate. The user can adjust the effective threshold according to the current noise level, then adjust the appropriate attack and release according to their needs, and finally select the appropriate damping.

Parameter Descriptions		
No.	Parameter	Description
1	Sensitivity	Adjusts the amount of compression. 0 = no compression.
2	Output	Adjusts the output volume of the compressor.
3	Attack	The startup time of the dynamic effect after the signal exceeds the set threshold. 100 = slowest attack, 0 = fastest attack.
4	Ratio	Compression Ratio. The ratio of input level to output level after the threshold is exceeded. A larger ratio produces a more pronounced compression effect, to a certain extent.
5	Threshold	Level threshold for triggering dynamic effects. The smaller the value, the easier it is to trigger, and at approximately 0 dB it is turned off.
6	Depth	Intel Reducer module's white noise suppression strength, the larger the value, the stronger the suppression strength.
7	Comp	Adjusts the amount of compression in a compression module. The larger the value, the more obvious the compression effect.
8	Low	Low frequency adjustment for the Boost compressor.
9	High	High frequency adjustment for the Boost compressor.
10	Gain	Adjusts gain at the output of the compressor.
11	Peak Reduction	Adjusts the amount of compression.
12	Mix	Mixing ratio of uncompressed signal and compressed signal. 0 = uncompressed signal only, 100 = compressed signal only
13	Release	The time it takes for the signal to return to normal from the compressed state after the input level falls below the set threshold. The larger the value, the longer the time.
14	Low Threshold	Low frequency threshold for the 3-band compressor.
15	Low Gain	Low frequency gain for the 3-band compressor.
16	Mid Threshold	Mid-range frequency threshold for the 3-band compressor.

17	Mid Gain	Mid-range gain for the 3-band compressor.
18	High Threshold	High frequency threshold for the 3-band compressor.
19	High Gain	High frequency gain for the 3-band compressor.
20	Sustain	Adjusts the amount of compression.
21	Blend	Adjusts the volume of the compressed signal. 0 = uncompressed signal only, 100 = compressed signal only
22	Damp	Adjusts how much the gate attenuates the noise when it is closed.

Filter modules

Effect Description		
No.	Model name	Description
1	Cry Wah	Modeled after a GCB95.
2	535 Wah	Modeled after a modern 535Q.
3	846 Wah	Modeled after a hand wired 60's classic with Halo inductor.
4	847 Wah	Modeled after a vintage voiced remake.
5	Mae Wah	Modeled after a custom modern Wah.
6	Custom Wah	Studio rack style unit. Tailor your perfect Wah.
7	Auto Wah	Modulated automatic sweeping Wah.
8	Touch Wah	Dynamic envelope filter auto Wah.
9	Talk Wah Ah	Talking Wah algorithm from the MOOER® Red Kid.
10	Talk Wah Oh	Talking Wah algorithm from the MOOER® Red Kid.
11	Low Pass Filter	Static low frequency pass filter.
12	High Pass Filter	Static high frequency pass filter.
13	Q-Filter	Static notch filter (like a half cocked Wah pedal).

Parameter Description		
No.	Parameter	Description
1	Peak	Controls the height of the resonance peak.
2	Rate	Adjusts the speed of the position sweep LFO.
3	Range	Adjusts the range of the position sweep.
4	Q	The Q or "Quality factor" is the ratio of the resonant frequency to the bandwidth, between the upper and lower -3dB frequencies. In this particular application, you can think of the Q as the shape of your band pass filter. A low Q will have a wider, rounder shape and sound less pronounced. A high Q will have a narrower, sharper shape and sound more pronounced.
5	Mix	Sets the proportion of mix between the original (dry) and 'effected' (wet) signals. 0 is total dry signal, 100 is total wet signal.
6	Position	The position of the Wah in its pedal sweep. 0 is equal to heel down, 100 is equal to toe down. *Notes: If you want to use the EXP pedal to control the Wah sweep, assign "WAH > Position" as the function in the EXP menu. You can also turn on 'Toe switch' function to turn on/off the Wah module while you are pressing the EXP pedal.
7	Low Fc	Low frequency cut.
8	High Fc	High frequency cut.
9	Curve	Waveform of the position sweep LFO. Trig: Triangular wave. Sine: Sine wave. Step: Stepped PWM style wave. Rand: Random pattern.
10	Attack	Speed of the envelope. 100 is the fastest.
11	Sensitive	Sensitivity of the envelope.
12	Direction	Direction of the band pass filter sweep.
13	Level	Adjusts the volume level of modulation.
14	Depth	Adjusts the depth of modulation.

Overdrive modules

Effect Description		
No.	Model name	Description
1	Pure Boost	Based on MOOER® Pure Boost
2	Flex Boost	Based on MOOER® Flex Boost
3	Tube DR	Based on B.K. Butler® Tubedrive
4	808	Based on IBANEZ® TS808
5	OD250	Based on DOD® OD250
6	D-Drive	Based on Barber® Direct Drive
7	Black Rat	Based on ProCo® Rat
8	Grey Faze	Based on MOOER® Grey Faze
9	Muffy	Based on EHX® Big Muff
10	Fuzz Department	Based on ZVEX® Fuzz Factory
11	MTL Zone	Based on BOSS® Metal Zone
12	MTL Master	Based on Digitech® Metal Master
13	Obsessive Dist	Based on Fulltone® OCD
14	Jimmy OD	Based on Paul Cochrane® Timmy OD
15	Full Dr	Based on Fulltone® Fulldrive 2
16	Shred	Based on Marshall® Shred Master
17	Beebee Pre	Based on Xotic® BB Preamp
18	Beebee+	Based on Xotic® BB Plus
19	Riet	Based on Suhr® Riot
20	Tight DS	Based on Amptweaker® Tight Rock
21	Full DS	Based on Fulltone® GT-500
22	Gold Clon	Based on Klon® Centaur Gold
23	VX Tube OD	Based on VOX® Tube OD
24	Tight Metal	Based on Amptweaker® Tight Metal
25	The Juicer	Based on MOOER® The Juicer
26	Rumble Drive	Based on MOOER® Rumble Drive
27	Solo	Based on MOOER® Solo
28	Blues Mood	Based on MOOER® Blues Mood
29	Blues Crab	Based on MOOER® Blues Crab
30	Blade	Based on MOOER® Blade
31	Hustle Drive	Based on MOOER® Hustle Drive
32	ROD 881	Based on MAXON® ROD-881
33	RED AT	Based on JHS® The AT
34	ODR1	Based on NOBELS® ODR-1
35	BE OD	Based on FRIEDMAN® BE-OD

Parameter Description		
No.	Parameter	Description
1	Gain	Adjusts the input gain and drive level.
2	Tone	Adjusts the tone color.
3	Vol	Adjusts the output volume level.

Note: The names of the manufacturers and products mentioned in this manual are the property of their respective companies and are used here only to illustrate the types of effect sounds simulated in this product.

Amplifier modules

Effect Description (Classic)		
No.	Model name	Description
1	65 US DLX	Based on Fender® 65 Deluxe Reverb (preamp only)
2	65 US TW	Based on Fender® 65 Twin Reverb (preamp only)
3	59 US BASS	Based on Fender® 59 Bassman (preamp only)
4	US Sonic	Based on Fender® Super Sonic (preamp only)
5	US BLUES CL	Based on Fender® Blues Deluxe Clean Setting (preamp only)
6	US BLUES OD	Based on Fender® Blues Deluxe Overdrive Setting (preamp only)
7	E650 CL	Based on ENGL® E650 Clean Setting (preamp only)
8	Powerbell CL	Based on ENGL® Powerball E645 Clean Setting (preamp only)
9	Blacknight CL	Based on ENGL® Blackmore Signature Clean Setting (preamp only)
10	MARK III CL	Based on MESA Boogie® MARK III Clean Setting (preamp only)
11	MARK V CL	Based on MESA Boogie® MARK V Clean Setting (preamp only)
12	Tri Rec CL	Based on MESA Boogie® Triple Rectifier Clean Setting (preamp only)
13	Rockvrb CL	Based on Orange® Rockverb Clean Setting (preamp only)
14	DR ZEE 18 JR	Based on DR.Z® Maz18 Jr (preamp only)
15	DR ZEE Reck	Based on DR.Z® Z-Wreck (preamp only)
16	JET 100H CL	Based on Jet City® JCA100H Clean Setting (preamp only)
17	JAZZ 120	Based on Roland® JC-120 (preamp only)
18	UK 30 CL	Based on VOX® AC30 Clean Setting (preamp only)
19	UK 30 OD	Based on VOX® AC30 Overdrive Setting (preamp only)
20	HWT 103	Based on Hiwatt® DR-103 (preamp only)
21	PV 5050 CL	Based on Peavey® 5150 Clean Setting (preamp only)
22	Regal Tone CL	Based on Tone King® Falcon Rhythm Setting (preamp only)
23	Regal Tone OD1	Based on Tone King® Falcon Tweed Setting (preamp only)
24	Carol CL	Based on Two Rock® Coral Clean Setting (preamp only)
25	Cardeff	Based on Two Rock® Cardiff (preamp only)
26	EV 5050 CL	Based on EVH® 5150 Clean Setting (preamp only)
27	HT Club CL	Based on Blackstar® HT Stage 100 Clean Setting (preamp only)
28	Hugen CL	Based on Diezel® Hagen Clean Setting (preamp only)
29	Koche OD	Based on Koch® Powertone Overdrive Setting (preamp only)
30	J800	Based on Marshall® JCM800 (preamp only)
31	J900	Based on Marshall® JCM900 (preamp only)
32	PLX 100	Based on Marshall® Plexi 100 (preamp only)
33	E650 DS	Based on Engl® E650 Distortion Setting (preamp only)
34	Powerbell DS	Based on ENGL® Powerball E645 Distortion Setting (preamp only)
35	Blacknight DS	Based on ENGL® Blackmore Signature Distortion Setting (preamp only)
36	MARK III DS	Based on MESA Boogie® MARK III Distortion Setting (preamp only)
37	MARK V DS	Based on MESA Boogie® MARK V Distortion Setting (preamp only)
38	Tri Rec DS	Based on MESA Boogie® Triple Rectifier Distortion Setting (preamp only)
39	Rockvrb DS	Based on Orange® Rockverb Distortion Setting (preamp only)
40	Citrus 30	Based on Orange® AD30 (preamp only)
41	Citrus 50	Based on Orange® OR50 (preamp only)
42	Slow 100 CR	Based on Soldano® SLO-100 Crunch Setting (preamp only)
43	Slow 100 DS	Based on Soldano® SLO-100 Distortion Setting (preamp only)
44	Jet 100H OD	Based on Jet City® JCA100H Overdrive Setting (preamp only)
45	PV 5050 DS	Based on Peavey® 5150 Distortion Setting (preamp only)
46	Regal Tone OD2	Based on Tone King® Falcon Lead Setting (preamp only)

47	Carol OD	Based on Two Rock® Coral Overdrive Setting (preamp only)
48	EV 5050 DS	Based on EVH® 5150 Distortion Setting (preamp only)
49	Ht Club DS	Based on Blackstar® HT Stage 100 Distortion Setting (preamp only)
50	Hugen OD	Based on Diezel® Hagen Overdrive Setting (preamp only)
51	Hugen DS	Based on Diezel® Hagen Distortion Setting (preamp only)
52	Koche DS	Based on Koch® Powertone Distortion Setting (preamp only)

Effect Description (Boutique preamps)		
No.	Model name	Description
1	62 US DX	Based on Fender® Brownface Deluxe (preamp only)
2	55 US TD	Based on Fender® Tweed Deluxe 1955 (preamp only)
3	59 US Bass	Based on Fender® 1959 Bassman (preamp only)
4	UK30 CL	Based on VOX® AC30 Clean Setting (preamp only)
5	UK30 CR	Based on VOX® AC30 Overdrive Setting (preamp only)
6	UK30 DS	Based on VOX® AC30 Distortion Setting (preamp only)
7	Matchbox 30 CL	Based on Matchless® C30 Clean Setting (preamp only)
8	Matchbox 30 OD	Based on Matchless® C30 Crunch Setting (preamp only)
9	Regal Tone SK CL	Based on Tone King® Sky King Clean Setting (preamp only)
10	Regal Tone SK CR	Based on Tone King® Sky King Crunch Setting (preamp only)
11	CAA OD100 CH1	Based on Custom Audio® OD100 Clean Setting (preamp only)
12	CAA OD100 CH2	Based on Custom Audio® OD 100 Crunch Setting (preamp only)
13	CAA OD100 CH3	Based on Custom Audio® OD100 Distortion Setting (preamp only)
14	SPT 100 CL	Based on Suhr® PT100 Clean Setting (preamp only)
15	SPT 100 DS	Based on Suhr® PT100 Distortion Setting (preamp only)
16	Rock Vrb CL	Based on Orange® Rockverb Clean Setting (preamp only)
17	Rock Vrb DS	Based on Orange® Rockverb Distortion Setting (preamp only)
18	J800 CL	Based on Marshall® JCM800 Clean Setting (preamp only)
19	J800 CR	Based on Marshall® JCM800 Crunch Setting (preamp only)
20	J800 DS	Based on Marshall® JCM800 Distortion Setting (preamp only)
21	PLX 100 CL	Based on Marshall® PLEXI 100 Clean Setting (preamp only)
22	PLX 100 DS	Based on Marshall® PLEXI 100 Distortion Setting (preamp only)
23	EV 5050 CH1	Based on EVH® 5150 III GREEN Channel (preamp only)
24	EV 5050 CH2	Based on EVH® 5150 III BLUE Channel (preamp only)
25	EV 5050 CH3	Based on EVH® 5150 III RED Channel (preamp only)
26	Cali BLD CL	Based on Mesa Boogie® Rectifier Badlander Clean Setting (preamp only)
27	Cali BLD CR	Based on Mesa Boogie® Rectifier Badlander Crunch Setting (preamp only)
28	Cali BLD DS	Based on Mesa Boogie® Rectifier Badlander Distortion Setting (preamp)

Effect Description (Boutique Full Amps)		
No.	Model name	Description
1	55 US TD	Based on Fender® Tweed Deluxe 1955
2	59 US Bass	Based on Fender® 1959 Bassman
3	UK30 CL	Based on VOX® AC30 Clean Setting
4	UK30 CR	Based on VOX® AC30 Crunch Setting
5	UK30 DS	Based on VOX® AC30 Distortion Setting
6	ODS 100 CL	Based on Dumble® ODS Clean Setting
7	ODS 100 CR	Based on Dumble® ODS Crunch Setting
8	ODS 100 DS	Based on Dumble® ODS Distortion Setting
9	Dividers CL	Based on Divided By 13® Clean Setting
10	Dividers DS	Based on Divided By 13® Distortion Setting

11	CAA OD100 CH1	Based on Custom Audio® OD100 Clean Setting
12	CAA OD100 CH2	Based on Custom Audio® OD100 Crunch Setting
13	CAA OD100 CH3	Based on Custom Audio® OD100 Distortion Setting
14	Rock Vrb CL	Based on Orange® Rockerverb Clean Setting
15	Rock Vrb DS	Based on Orange® Rockerverb Distortion Setting
16	J800 CL	Based on Marshall® JCM800 Clean Setting
17	J800 CR	Based on Marshall® JCM800 Crunch Setting
18	J800 DS	Based on Marshall® JCM800 Distortion Setting
19	PLX 100 CL	Based on Marshall® Plexi 100 Clean Setting
20	PLX 100 DS	Based on Marshall® Plexi 100 Distortion Setting
21	EV 5050 CH1	Based on EVH® 5150 III Green Channel
22	EV 5050 CH2	Based on EVH® 5150 III Blue Channel
23	EV 5050 CH3	Based on EVH® 5150 III Red Channel
24	Cali BLD CL	Based on Mesa Boogie® Rectifier Badlander Clean Setting
25	Cali BLD CR	Based on Mesa Boogie® Rectifier Badlander Crunch Setting
26	Cali BLD DS	Based on Mesa Boogie® Rectifier Badlander Distortion Setting

Effect Description (Bass Amps)		
No.	Model name	Description
1	Ampeg 20D	Based on Ampeg® 20D
2	Ampeg B18 CL	Based on Ampeg® B18 Clean Setting
3	Ampeg SV4T	Based on Ampeg® SVT 4 Pro
4	Ampeg SVT VALVE	Based on Ampeg® SVT 7 Pro
5	Markbass 500	Based on Markbass® R500
6	Markbass 501	Based on Markbass® TA501
7	Akuila 750 CL	Based on Aguilar® DB750 Clean Setting
8	Akuila 750 DS	Based on Aguilar® DB750 High Gain Setting
9	Akuila 751	Based on Aguilar® DB751 Overdrive Setting
10	Basser Crunch	Based on Dark Glass® B7K

Parameter Description		
No.	Parameter	Description
1	Gain	Adjusts the input gain and drive level.
2	Bass	Adjusts the low frequency level.
3	Mid	Adjusts the middle frequency level.
4	Treble	Adjusts the high frequency level.
5	Brightness	Adjusts the higher frequencies of the AMP block.
6	Master	Final output level of the AMP block.

Note: The names of the manufacturers and products covered in this manual are the property of their respective companies, and are used here only for the purpose of illustrating the types of effect tones simulated in this product.

Poweramp Modules

Effect Description		
No.	Model name	Description
1	Normal el34	Based on EL34 power tube.
2	Normal el84	Based on EL84 power tube.
3	Normal 6L6	Based on 6L6 power tube.
4	Normal 6v6	Based on 6V6 power tube.
5	Doctor 3 el84	Based on Dr.Z® Z-Wreck EL84 power tube.
6	Badger el34	Based on Suhr® PT100 power tube.
7	Uk Gold el34	Based on Marshall® JVM 410H power tube.
8	Cali 6L6	Based on Mesa Boogie® Triple Rectifier power tube.
9	US DLX 6L6	Based on Fender® Blues Deluxe power tube.
10	JJ el84	Based on JJ® EL84 power tube.
11	Baby Bomb	Based on Mooer® Baby Bomb.

Parameter Description		
No.	Parameter name	Description
1	Power Amp Input	Adjusts the input level of the power amp.
2	Presence	Adjusts the high frequencies of the power amp (about 8 kHz).
3	Bias	Adjusts the simulated tube bias of the power amp.

Cabinet modules

Effect Description (Classic)		
No.	Model name	Description
1	Regal Tone 110	Based on Tone King® Falcon 110 Cabinet
2	US DLX 112	Based on Fender® 65 Deluxe Reverb 112 Cabinet
3	Sonic 112	Based on Fender® Super Sonic 112 Cabinet
4	Blues 112	Based on Fender® Blues Deluxe 112 Cabinet
5	Mark 112	Based on Mesa Boogie® Mark 112 Cabinet
6	Dr Zee 112	Based on DR.Z® MAZ 112 Cabinet
7	Cardiff 112	Based on Two Rock® 112 Cabinet
8	US TW 212	Based on Fender® 65 Twin Reverb 212 Cabinet
9	Citrus 212	Based on Orange® PPC 212 Cabinet
10	DR ZEE 212	Based on DR.Z® Z-Wreck 212 Cabinet
11	Jazz 212	Based on Roland® JC120 212 Cabinet
12	UK 212	Based on VOX® AC30 212 Cabinet
13	Tow Stones 212	Based on Two Rock® 212 Cabinet
14	US Bass 410	Based on Fender® 59 Bassman 410 Cabinet
15	1960 412	Based on Marshall® 1960A 412 Cabinet
16	Eagle p412	Based on ENGL® Pro XXL 412 Cabinet
17	Eagle s412	Based on ENGL® Vintage XXL 412 Cabinet
18	Rec 412	Based on Mesa Boogie® Rectifier Standard 412 Cabinet
19	Citrus 412	Based on Orange® PPC 412 Cabinet
20	Slow 412	Based on Soldano® Slo 412 Cabinet
21	HWT 412	Based on Hiwatt® AP412 Cabinet
22	PV 5050 412	Based on Peavey® 5150 412 Cabinet
23	EV 5050 412	Based on EVH® 5150 412 Cabinet
24	HT 412	Based on Blackstar® HTV 412 Cabinet
25	Diesel 412	Based on Diezel® Hagen 412 Cabinet

Effect Description (Boutique)		
No.	Model name	Description
1	US DLX 112	Based on Fender® Deluxe 112 Cabinet
2	US TWN 212	Based on Fender® Twin Reverb 212 Cabinet
3	US Bass 410	Based on Fender® Bassman 410 Cabinet
4	UK 212	Based on VOX® Silver Alnico 212 Cabinet
5	Matchbox 30 112	Based on Matchless® C30 112 Cabinet
6	Regal Tone FLN 110	Based on Toneking® Falcon 110 Cabinet
7	Regal Tone SK 112	Based on Toneking® Sky King 112 Cabinet
8	Custom 112	Based on Custom Audio® 112 Cabinet
9	Custom 212	Based on Custom Audio® 212 Cabinet
10	Custom 412	Based on Custom Audio® 412 Cabinet
11	SPT 112	Based on Suhr® PT100 112 Cabinet
12	SPT 212	Based on Suhr® PT100 212 Cabinet
13	SPT 412	Based on Suhr® PT100 412 Cabinet
14	CITRUS 112	Based on Orange® PPC 112 Cabinet
15	CITRUS 212	Based on Orange® PPC 212 Cabinet
16	CITRUS 412	Based on Orange® PPC 412 Cabinet
17	1960 412 A	Based on Marshall® 1960A 4x12 Cabinet
18	1960 412 B	Based on Marshall® 1960TV 412 Cabinet
19	1960 412 C	Based on Marshall® 1960BV 412 Cabinet
20	EV 5050 212	Based on EVH® 5150III 212 Cabinet
21	EV 5050 412	Based on EVH® 5150III 412 Cabinet
22	Cali 412 A	Based on Mesa Boogie® 4x12 Recto® Traditional Slant Cabinet
23	Cali 412 B	Based on Mesa Boogie® 4x12 Recto® Traditional Straight Cabinet
24	Cali 412 C	Based on Mesa Boogie® Road King® 4x12 Straight Cabinet
25	CT-SupBMK112	Based on Supro® Black Magick 1x12 Cabinet (ChopTones active)
26	CT-FendS212	Based on Fender® Super Sonic 2x12 Cabinet (ChopTones active)
27	CT-FendTW212	Based on Fender® Twin Reverb 65 Reissue 2x12 Cabinet (ChopTones active)
28	CT-Fend67212	Based on Fender® 1967 Bassman 2x12 Cabinet (ChopTones active)
29	CT-BritJV212	Based on Marshall® JVM 2x12 Cabinet (ChopTones active)
30	CT-Brit412	Based on Marshall® 1960 4x12 Cabinet (ChopTones active)
31	CT-BritJ412	Based on Marshall® 1982 4x12 Cabinet (ChopTones active)
32	CT-Bogie212	Based on Mesa Boogie® 2x12 Cabinet (ChopTones active)
33	CT-BogieLS212	Based on Mesa Boogie® Lonestar 2x12 Cabinet (ChopTones active)
34	CT-BogOS412	Based on Mesa Boogie® OS 4x12 Cabinet (ChopTones active)
35	CT-Vocs212	Based on VOX® BNX 2x12 Cabinet (ChopTones active)
36	CT-Barb212	Based on Mezzabarba® 2x12 Cabinet (ChopTones active)
37	CT-Fram212	Based on Framus® CB 2x12 Cabinet (ChopTones active)
38	CT-Kox212	Based on Koch® Multitone 2x12 Cabinet (ChopTones active)
39	CT-Mgan212	Based on Morgan® Vertical 2x12 Cabinet (ChopTones active)
40	CT-Edd412	Based on EVH® 5150III 4x12 Cabinet (ChopTones active)
41	CT-Fried412	Based on Friedman® 4x12 Cabinet (ChopTones active)
42	CT-Gas412	Based on Diezel® 4x12 Cabinet (ChopTones active)
43	CT-Hess212	Based on Hesu® Modern 2x12 Cabinet (ChopTones active)
44	CT-Hess412	Based on Hesu® 4x12 Cabinet (ChopTones active)
45	CT-HW412	Based on Hiwatt® 4x12 Cabinet (ChopTones active)
46	CT-HK412	Based on Hughes&Kettner® Triamp 4x12 Cabinet (ChopTones active)
48	CT-OR412	Based on Orange® PPC412 4x12 Cabinet (ChopTones active)

49	CT-PvyIn212	Based on Peavey® Invective 2x12 Cabinet (ChopTones active)
50	CT-Pvy50412	Based on Peavey® 5150 4x12 Cabinet (ChopTones active)
51	CT-River412	Based on Rivera® 4x12 Cabinet (ChopTones active)
52	CT-Sold412	Based on Soldano® 4x12 Cabinet (ChopTones active)
53	CT-VTH412	Based on VHT® 4x12 Cabinet (ChopTones active)
54	CT-Win412	Based on Victory® 4x12 Cabinet (ChopTones active)

Effect Description (Bass Cabinets)		
No.	Model name	Description
1	SV810 U47	Based on the Ampeg® SVT-810E cabinet (Neumann® U47 microphone)
2	SV810 7B	Based on the Ampeg® SVT-810E cabinet (Shure® SM7B microphone)
3	SV810 121	Based on the Ampeg® SVT-810E cabinet (Royer® R-121 microphone)
4	HK U47	Based on the Hartke® 45XL cabinet (the Neumann® U47 microphone)
5	HK U7B	Based on Hartke® 45XL cabinet (Shure® SM7B microphone)
6	HK 121	Based on Hartke® 45XL cabinet (Royer® R-121 microphone)
7	HK 421	Based on Hartke® 45XL cabinet (Sennheiser® MD-421 microphone)
8	Akuila U47	Based on Aguilar® DB115 cabinet (Neumann® U47 microphone)
9	Akuila 7B	Based on Aguilar® DB115 cabinet (Shure® SM7B microphone)
10	Basser 121	Based on Aguilar® DB115 cabinet (Royer® R-121 microphone)

Parameter Description		
No.	Parameter	Description
1	Low Cut	Low frequency cut after the microphones
2	High Cut	High frequency cut after the microphones
3	Early Reflection	Adds a very slight delay for indoor sound and feel. 0 = no reflection.
4	Sample	Adjusts the sample rate
5	Output	Adjust the output volume level of the module.

Note: The names of the manufacturers and products covered in this manual are the property of their respective companies, and are used here only for the purpose of illustrating the types of effect tones simulated in this product.

Equalizer modules

Effect Description		
No.	Model name	Description
1	3 bands EQ	Simple amp style 3-band EQ.
2	5 Bands EQ	Simple amp style 5-band EQ.
3	MOOER HM	Stompbox style 5-band EQ for heavy guitar.
4	MOOER B	Stompbox style 6-band EQ for guitar.
5	MOOER G6	Stompbox style 6-band EQ for guitar.
6	MOOER G10	Stompbox style 10-band EQ for guitar.
7	Custom EQ	Stompbox style 3-band EQ with adjustable frequency bands.
8	STUDIO EQ Pro	Fully customizable parametric EQ.
9	AI EQ Master	AI EQ module with advanced artificial intelligence program.

Parameter Description		
No.	Parameter	Description
1	100Hz	Adjusts the gain level at 100 Hz.
2	630Hz	Adjusts the gain level at 630 Hz.
3	1.6kHz	Adjusts the gain level at 1600 Hz.
4	4kHz	Adjusts the gain level at 4000 Hz.
5	Output	Adjusts the output level.
6	Low Gain	Adjusts the gain level of the low frequencies.
7	Low Freq	Specifies the center of the custom low frequency range that will be adjusted by the Low Gain.
8	Mid Gain	Adjusts the gain level of the mid frequencies
9	Mid Freq	Specifies the center of the custom middle frequency range that will be adjusted by the Mid Gain.
10	High Gain	Adjusts the gain level of the high frequencies.
11	High Freq	Specifies the center of the custom high frequency range that will be adjusted by the High Gain.
12	Low	Adjusts the gain level of the low frequencies.
13	Mid	Adjusts the gain level of the mid frequencies.
14	High	Adjusts the gain level of the high frequencies.
15	Output	Adjusts the output level.
16	Band 1 Gain	Adjusts the Band 1 gain level.
17	Band 1 Freq	Adjusts the center of the Band 1 frequency range that will be adjusted by the Band 1 Gain.
18	Band 1 Q	Adjusts the width of the area affected by the EQ centered at the freq. Higher values will narrow the area.
19	Band 2 Gain	Adjusts the Band 2 gain level.
20	Band 2 Freq	Adjusts the center of the Band 2 frequency range that will be adjusted by the Band 2 Gain.
21	Band 2 Q	Adjusts the width of the area affected by the EQ centered at the freq. Higher values will narrow the area.
22	Band 3 Gain	Adjusts the Band 3 gain level.
23	Band 3 Freq	Adjusts the center of the Band 3 frequency range that will be adjusted by the Band 3 Gain.
24	Band 3 Q	Adjusts the width of the area affected by the EQ centered at the freq. Higher values will narrow the area.
25	Band 4 Gain	Adjusts the Band 4 gain level.
26	Band 4 Freq	Adjusts the center of the Band 4 frequency range that will be adjusted by the Band 4 Gain.

27	Band 4 Q	Adjusts the width of the area affected by the EQ centered at the freq. Higher values will narrow the area.
28	Low Cut	Sets the frequency at which the low cut filter begins to take effect.
29	High Cut	Sets the frequency at which the high cut filter begins to take effect.
30	Type	Choose the type of your music (Clean/Drive/Distortion).
31	Genre	Choose the genre of your music (Pop/Jazz/Rock/Blues/Funk/Metal)
32	Slot	The slot for storing the preset in the GS1000.

FX Loop module

Effect Description		
No.	Model name	Description
1	Fx Loop	Module that can be used to integrate your favorite external effects and preamps into the signal chain, or to integrate the GS1000 into creative and complex setups.
2	Fx Send	The normal Fx Loop module with only the "Send" function, you can use it to send the internal signal to an external device.
3	Fx Return	The normal Fx Loop module with only the "Return" function, you can use it to insert the signal from an external device into the internal effect chain.

Parameter Description		
No.	Parameter	Description
1	Type	Choose between Send or Return.
2	Mode	Choose between serial effects loop and parallel effects loop.
3	Dry/Wet	Progressively adjusts the wet/dry mix when in parallel mode. 100% Wet will send 100% of the signal through the FX LOOP just like Serial mode. 100% Dry will bypass the FX LOOP completely.
4	Send Level	Adjusts the volume level from the effects loop send output.
5	Return Level	Adjusts the recovery level at the effects loop return inputs.

Modulation modules

Effect Description		
No.	Model name	Description
1	Phaser	Based on the MOOER® Ninety Orange.
2	Step phaser	Square wave phase shifter.
3	Fat Phaser	Low frequency phase shifter.
4	6 Stage Analog Phaser	Six stages phase shifter.
5	12 Stage Analog Phaser	Twelve stages phase shifter.
6	Dual Phaser	Dual channel phase shifter.
7	Modern Phaser	Modern sound phase shifter.
8	Flanger	Based on the MOOER® E-Lady.
9	Jet Flanger	Based on the MOOER® Jet Flanger.
10	Flanger Pro	Professional flanger effect with more parameter controls.
11	Triple Flanger	Rich multi-stage flanger.
12	Modern Flanger	Modern sound flanger.
13	Tremolo	Based on the MOOER® Trelicopter.
14	Optical Tremolo	Simulates a device that reads a pattern printed on a rotating disc and converts it into a volume-modulating "tremolo" sound.
15	60s Tremolo	Pure vintage 60s sound tremolo.
16	Stutter	Choppy cut off filter.

17	Panner	Pans through the left and right phase shift to achieve a different stereo effect.
18	Vibrato	Pitch modulation.
19	Rotary	Simulates a vintage Leslie rotary speaker.
20	Modern Rotary	Modern sounding rotary effect.
21	Ana Chorus	Stompbox style analog chorus.
22	70s Chorus	70s style sound analog chorus.
23	Tri Chorus	Rich multi-stage chorus.
24	Detune	Fine-tuned pitch adjustment.
25	Octave	Adds a note one octave lower or higher.
26	Ring	Ring modulator.
27	Lofi	Low sampling rate filter.
28	Poly Shift	Poly pitch shifter.
29	Slow Gear	Auto volume swell.
30	Harmony	Harmonic effect.

Effect Description (V2)		
No.	Model name	Description
1	60s Vibe	Analog 60s surround sound effect.
2	Double	Multiple Sound Overlay Effects.
3	Stereo Rotary	Rotary effect with Strong Stereo Sound.

Parameter Description		
No.	Model name	Description
1	Rate	Adjusts the speed of modulation.
2	Level	Adjusts the level of modulation.
3	Depth	Adjusts the depth of modulation.
4	Tone	Adjusts the tone of modulation.
5	Mix	Sets the proportion between the original signal (dry) and the effect signal (wet). 0 is 100% dry, 100 is 100% wet.
6	Feedback	Adjusts the volume that is returned to the input. Higher settings will result in more delay repeats.
7	Pitch	Sets the pitch shift value. (Detune : -100 cents to 100 cents; Poly Shift: -1 oct to +1 oct)
8	Sample	Adjusts the sample rate of the Lofi effect.
9	Bit	Adjusts the bit rate of the Lofi effect.
10	Rise	Adjusts the time needed for the volume to reach its maximum. 100 is the slowest.
11	Sweep	Moves the frequency response pattern through a six-octave or twelve-octave range.
12	Resonance	Changes the amplitude and sharpness of the frequency response peaks.
13	Delay	Sets the delay time for the flanger.
14	Manual	Adjusts the depth of modulation.
15	Width	Adjusts the LFO width of the flanger.
16	Speed	Adjusts the speed of modulation.
17	Intensity	Sets the Modulation amount.
18	Duty	Adjusts the ratio of the left panning duration to the whole panning period. 0 = shortest duration, 50 = left duration : right duration = 1:1, 100 = longest duration.
19	Sub	Adjusts the volume of the lower octave of the Octave effect.
20	Sub Tone	Adjusts the tone of the lower octave of the Octave effect.
21	Upper	Adjusts the volume of the upper octave of the Octave effect.

22	Upper Tone	Adjusts the tone of the upper octave of the Octave effect.
23	Dry	Adjusts the volume of the dry signal.

Time delay modules

Effect Description		
No.	Model name	Description
1	Digital	Recreates the crystal-clear repeats of the 80's delay units.
2	Analog	Modeled after classic stompbox delays with BB chips.
3	Real Echo	Realistic and natural echoes.
4	Tape	Recreates swirly 70's tape echo.
5	Mod	Digital Delay with modulated repeats.
6	Reverse	Clear reverse delay.
7	Dynamic	Digital Delay which responds to instrument dynamics.
8	Pingpong	Normal Ping Pong sound stereo delay.
9	Crystal	Delay with shimmer harmonization and modulation sound mixed in.
10	Rainbow	Special effect pitch Delay with modulation.
11	Sweep	Delay with a modulated envelope reverb.
12	Dual Delay	2 clear delays with independent controls.
13	Multi Tap Delay	3 clear delays with independent controls.
14	Vintage Delay	Delay with low-bit effect mixed in.
15	Galaxy Delay	Delay with swelled repeats and a light modulation.
16	Fuzz Delay	Delay with classic stompbox Fuzz mixed in.

Effect Description (V2)		
No.	Model name	Description
1	Studio	Studio-Delay simulation.
2	Morph PingPong	Smoothly transforming stereo ping-pong delay.
3	Liquid	Reproduces the echo tones of real space.

Parameter Description		
No.	Parameter	Description
1	Level	Sets the independent delay level with independent level parameter.
2	Feedback	Adjusts the number of delay repeats.
3	Time	Adjusts the delay repeat time in Milliseconds / Sets the delay repeat time in relation to the preset tempo (Tempo Sync On).
4	Depth	Adjusts the modulation width of the delay repeats.
5	Rate	Adjusts the modulation speed of the delay repeats.
6	Tempo Sync (off/on)	Activates preset tempo synchronization and sub-division parameter.
7	Trail (off/on)	Activates the trail function for some effects.
8	Mod Rate	Adjusts the modulation width of the delay repeats.
9	Mode Depth	Adjusts the depth of the delay repeats.
10	High Cut	Sets a high frequency EQ shelf for the delay repeats.
11	Low Cut	Sets a low frequency EQ shelf for the delay repeats.
12	Threshold	Sets the envelope detection level of the dynamic delay.
13	Mod Output	Adjusts the output level of the modulation.
14	Filter (lp/bp/hp)	Choose the type of the filter envelopes. (lp: low pass / bp: band pass / hp: high pass).
15	Range	Range of the sweep.
16	Pan	Pans the delay effect left (L), right (R) or centre.
17	Bit	Adjusts the sampling accuracy of the delay repeats.

18	S-Rate	Adjusts the sampling rate of the delay repeats.
19	Attack	Adjusts the speed of the GALAXY sound. 100 is the fastest.
20	Gain	Adjusts amount of distortion of the fuzz.
21	Fuzz Level	Adjusts the mix level of the fuzz.
22	Tone	Adjusts the EQ of the fuzz.
23	Cab	Adds tone compensation to the fuzz for output to full range rigs.
24	Mix Ratio	The mix ratio of the delay effect: Mix=0 for pure dry sound, Mix=100 for pure wet sound.
25	Effect Mode (Mono/Stereo)	Switches between Stereo and Mono output.
26	Modulation Effect Volume	Adjust the volume level of the modulation effect of the partial delay, the larger the value, the more obvious the effect.
27	Saturation Gain	Adjust the tube gain for analogue saturation.

Reverb modules

Effect Description		
No.	Model name	Description
1	Room	Small room reverb
2	Hall	Concert hall reverb
3	Plate	Studio style plate reverb
4	Spring	Classic spring reverb tank
5	Mod	Reverb with modulation effect
6	Filter Reverb	Reverb with static filter effect
7	Fl-Reverb	Reverb with flange effect
8	Reverse Reverb	Backwards Reverb
9	Swell Reverb	Brings in the reverb gradually behind the dry signal
10	Dist Reverb	Reverb with distortion
11	Shimmer	Simulates reverberation with a distinctively sparkling high-frequency range.

Effect Description (V2)		
No.	Model name	Description
1	Theater	Reverb in large, enclosed environments.
2	Chorus Reverb	Chorus is added to the Reverb sound for a detailed reverb effect.
3	Cathedral	Church Reverb for larger spaces with longer decay times.

Parameter Description		
No.	Model name	Description
1	Pre (Pre-Delay)	Delay time before the first reflections can be heard.
2	Level	Adjusts the effect level.
3	Decay	Length of the reverb trails.
4	Tone	Adjusts the tone of the reverb.
5	Mix	Mix rate of the dry signal and wet signal. 0 is 100% dry sound. 100 is 100% reverb sound.
6	Low Cut	Low frequency EQ shelf
7	High Cut	High frequency EQ shelf
8	Quality	Choose between standard quality and high quality. High quality uses more CPU%.
9	Spring Length	Simulated size of the springs in the spring tank.
10	Spring Depth	Mix of the spring sound in the reverb trails.
11	Rate	Adjusts modulation speed. 100 is the fastest

12	Depth	Adjusts the modulation width of the reverb trails.
13	Mod Level	Adjusts the modulation mix on the reverb trails.
14	Peak	Adjusts the frequency of the filter peak
15	Q	Filter bandwidth. High Q = narrow bandwidth.
16	Filter Level	Adjusts the volume level of the filter applied to the reverb trails.
17	Feedback	Adjusts the feedback intensity of the flanging.
18	Mod-Delay	Adjusts the feedback frequency of the flanging
19	Attack	Rate of automatic volume swell of the reverb effect. 100 is the fastest.
20	Gain	Adjusts amount of distortion.
21	Dist Level	Adjusts the mix level of the distortion
22	Cab	Adds tone compensation to the distortion for output to full range rigs.
23	Shimmer	Volume level of the shimmer harmonization.
24	Tail Hold (On/Off)	Activates the Trail feature (Spill-Over).
25	Effect Mode (Mono/Stereo)	Switches between Stereo and Mono output.

Note: The names of the manufacturers and products mentioned in this manual are the property of their respective companies and are used here only to illustrate the types of effect sounds simulated in this product.