

Kingmaker Fuzz User's Guide



Welcome

Thank you for purchasing the Kingmaker Fuzz. This powerful stereo effects pedal features a collection of meticulously crafted Fuzz sounds ranging from subtly driven sustain to highly saturated fuzz to screaming octave fuzz and beyond. With a simple control set, the Kingmaker can work in a wide variety of musical settings, and the powerful MIDI and Neuro control options under the hood provide access to a vast array of additional tonal possibilities.

The Kingmaker is housed in a durable, lightweight aluminum housing, packing rack mount power and flexibility into a compact, easy-to-use stompbox.

The USB and Neuro ports transform the Kingmaker from a simple fuzz pedal into a powerful multi-effects unit. Using the free Neuro App (iOS / Android), a wide range of additional control parameters and effect types (including a large collection of overdrive, fuzz, and distortion sounds) are accessible. When used together with the Neuro Hub, the Kingmaker is fully MIDI-controllable and 128 multi-pedal presets, or “scenes,” can be saved for instant recall on the stage or in the studio. The Kingmaker can also connect directly to a passive expression pedal for expressive control of any parameter.

The [Quick Start](#) guide will help you with the basics. For more in-depth information about the Kingmaker Fuzz, move on to the following sections, starting with [Connections](#).

Enjoy!

- The Source Audio Team

Overview

Diverse Fuzz Sounds – Choose from traditional Fuzz tones such as Heavy, Normal, and Octave, or delve deeper into unique sounds cooked up in the Source Audio lab.

Compact Design – The durable, anodized aluminum housing has a slim profile, a small footprint, and sturdy hardware that will withstand the rigors of the road.

Universal Bypass™ – True bypass or buffered bypass? The choice is yours. The Kingmaker features high-quality signal relays for true bypass and transparent buffers for analog bypass.

Stacking – Stack two independent distortion circuits in series (or in parallel), all within the same box!

Dual 4-Band EQ + Low Cut – Two independent parametric EQs are included in the Kingmaker, allowing for fine tone control. An optional low cut filter tightens up the low end for bass players.

Flexible Routing – The Kingmaker is equally at home in a mono rig or a stereo rig. A variety of routing modes such as True Stereo, Cascade, Parallel, Dry Sidechain and External Loop allow the Kingmaker to harness the true power of stereo signal chains. Or just use it in Mono mode!

True Stereo – Two independent drive circuits create a stereo signal path for true stereo setups.

Preset Saving – Save your favorite sound by pressing and holding the footswitch. No need to remember knob positions in the middle of a show.

Neuro Technology – The Neuro App opens up new possibilities for the Kingmaker, including completely new effect types, additional control parameters, and access to the Neuro Community, including free presets from artists and other users. The Neuro Hub can store up to 128 presets for the Kingmaker, easily recalled with a MIDI controller. You can also download any effects for the L.A. Lady Overdrive and Aftershock Bass Distortion and use them on the Kingmaker Fuzz.

Deep Control Set – Beyond the four knobs on the face of the Kingmaker are many additional parameters. The Neuro App provides access to the inner workings of the Fuzz effect for advanced users who want to create a unique signature sound.

Noise Gate – The built-in adjustable noise gate helps remove unwanted noise.

Clean Path – The clean signal can be mixed in with the fuzz as desired, perfect for bass players who want to hold down the rhythm section with a clean low end.

MIDI Control – All of the Kingmaker's parameters can be accessed and controlled using MIDI via the Neuro Hub or USB. Class compliant USB-MIDI allows the Kingmaker to work as a plug-and-play device with recording software running on Mac and Windows, and the MIDI Learn feature makes control mapping simple.

Quick Start

Power

To power the unit, connect the included 9V DC power supply to the jack labeled **DC 9V** on the back panel.

Warning: Using a non-Source Audio supply, especially an unregulated supply, could damage the unit. Please be very cautious when using 3rd-party power supplies.

Guitar/Audio Connections

Using standard ¼" mono cables, connect your guitar, bass, or other instrument to the INPUT 1 jack and your amp (or the next audio device in the signal chain) to the OUTPUT 1 jack.

When the power and audio connections have been made, the Kingmaker is ready to play.

Brief Knob, Footswitch, and Button Descriptions

Drive Knob: Controls the amount of gain into the fuzz circuit, which sets the amount of distortion and sustain.

Level Knob: Controls the overall output level.

Bass Knob: Controls the level of the bass frequencies in the drive circuit.

Treble Knob: Controls the level of the treble frequencies in the drive circuit.

Effect Switch: Selects between the three basic Fuzz effect types – Heavy, Normal, and Octave.

Footswitch: Enables or bypasses the Fuzz effect. The ON/OFF LED will be lit green when the Fuzz effect is engaged.

Contents

Welcome.....	1
Overview.....	2
Quick Start.....	3
Connections.....	5
Effect Types.....	8
Controls.....	9
Preset Storage and Recall.....	11
Universal Bypass™.....	11
Stacking and Parallel Processing “Inside the Box”.....	12
Stereo Routing.....	13
Parametric EQ.....	16
Low Cut Filter.....	17
LoRetain.....	18
Voice Control.....	18
Noise Gate.....	18
External Control.....	18
Neuro App.....	22
Specifications.....	32
Troubleshooting.....	33
Frequently Asked Questions.....	34
Rubber Feet.....	36
Waste Disposal Notes.....	36
Warranty.....	36
Version History.....	37

Connections

Input Side Connections



Input 1

This is the primary input for guitar, bass, or other instruments. It can also accept line-level inputs. Connect it to your instrument or other audio source using a mono (TS) ¼" cable.

Input 2

Input 2 can act either as an audio input or as the data connection for the Neuro App, or both at the same time.

Input 2 as an Audio Input

The tip contact on Input 2 acts as a secondary input for guitar, bass, or other instruments. It is only active when the Kingmaker is configured with a signal routing that uses stereo inputs. Connect it to your instrument (or the previous effect in the signal chain) using a mono (TS) ¼" cable. By default, the Kingmaker will auto-detect the routing mode. Other routing options are available using the Neuro App. For more information about stereo routing, refer to the [Stereo Routing](#) section.

Input 2 as a Neuro App Data Input

The ring contact on Input 2 acts as a data connection for the Neuro App. Connect it to your mobile device using a stereo (TRS) ¼" cable. It can also accept daisy-chained Neuro data from another Neuro-compatible pedal in the chain, provided that a TRS cable is used. The audio signal (if applicable) will be on the tip contact of the plug, and the Neuro App data will be on the ring contact.

Input 2 only accepts data from the Neuro App. Data from the Neuro Hub comes from the Control Input port.

Output Side Connections



Output 1

This is the primary output. Connect it to your amplifier, recording interface, or the next device in your effects signal chain using a mono (TS) ¼" cable.

Output 2

Output 2 can act either as an audio output or as the daisy-chain data connection for the Neuro App, or both.

Output 2 as an Audio Output

The tip contact on Output 2 acts as the secondary audio output. It carries an audio signal when the Kingmaker is configured with a signal routing that uses stereo outputs. Connect it to your amplifier, recording interface, or the next device in your effects signal chain using a mono (TS) ¼" cable.

Output 2 as a Neuro App Data Daisy-Chain Output

The ring contact on Output 2 acts as a data connection for the Neuro App, passing data from the Kingmaker to the next Source Audio effect in your signal chain. You can daisy-chain the Neuro App data regardless of whether Output 2 is configured to output audio or not. Connect Output 2 to the next device's Neuro App Data input (usually Input 2) using a stereo (TRS) ¼" cable. The audio signal (if applicable) will be on the tip contact of the plug, and the Neuro App data will be on the ring contact.

Power and Control Connections



DC 9V (Power)

Connect to the included 9 Volt DC power supply. The power supply must be regulated at 9 Volts (direct current), able to source at least 180 mA (milliamps) of current, and the plug should have a tip-negative, sleeve-positive polarity (the center tip is ground and the sleeve is power).

USB

Connect to your computer (Mac or Windows) to the Kingmaker's USB port (denoted by the  icon) using a standard mini USB cable. The Kingmaker is a class compliant USB device, meaning that it should be recognized by Mac and Windows computers automatically. For more information about the Kingmaker's USB capabilities, refer to the [USB](#) section of the User's Guide.

Control Input

The 3.5 mm Control Input port connects to external control devices such as the Dual Expression Pedal, Reflex Universal Expression Pedal, Neuro Hub, and Hot Hand Motion Controller. For more information, refer to the [Expression Pedal Input](#), [Hot Hand Input](#), and [Neuro Hub](#) sections of the User's Guide.

Effect Types

The Kingmaker includes three basic fuzz types, with more effects available in the Neuro mobile app.

Heavy

The Heavy circuit offers the extreme in guitar fuzz. Plenty of low-end and endless sustain creates a “violin” like fuzz.

Normal

The Normal circuit generates a vintage fuzz that is a bit cleaner than the Heavy circuit. This highly transparent fuzz delivers that damaged speaker sound that has graced so many great records.

Octave

The Octave circuit generates a soaring octave up effect along with some very nasty fuzz. Try turning down the tone knob on your guitar to really bring out the higher octave.

Additional Effect Types

Additional effect types can be loaded into the Kingmaker using the Neuro App on your mobile device (iOS / Android) or the built-in USB port (Mac / Windows).

The Kingmaker Fuzz is compatible with Source Audio’s Overdrive and Distortion effects, so it is possible to load Overdrive, Distortion, and Fuzz effects on the Kingmaker at the same time.

Controls



Knobs

Drive Knob

The DRIVE KNOB adjusts the amount of gain applied to the signal. Dial down the drive for a cleaner, more articulate tone or crank it up for over-the-top doses of fuzz.

Level Knob

Adjusts the output level of the effect. This is useful for setting the level of the fuzz effect compared to the bypassed signal. Note that because the fuzz effect compresses the signal in the clipping/saturation stage, the dynamic range of the distorted signal will be less than the dry signal, and the LEVEL KNOB can be used to compensate for the loss of level that results from this compression.

Bass Knob

The BASS KNOB adjusts a low shelf tone control. Turning the knob clockwise will boost the bass; turning the knob counter-clockwise will cut the bass. The function of this knob can be reassigned using the Neuro App.

Treble Knob

The TREBLE KNOB adjusts a high shelf tone control. Turning the knob clockwise will boost the treble; turning the knob counter-clockwise will cut the treble. The function of this knob can be reassigned using the Neuro App.

Knob Reassignment

Using the Neuro App, the functions of the Bass Knob and Treble Knob can be reassigned to other parameters:

- Bass Level or Treble Level (Default) – Controls the amount of boost or cut in the bass or treble band, respectively.
- Treble Frequency – Sets the frequency for the shelf of the treble band.
- Bass Frequency – Sets the frequency for the shelf of the bass band.
- Mid A Level – Controls the amount of boost or cut in the Mid A band.
- Mid A Frequency – Sets the center frequency of the Mid A peaking filter band.
- Mid A Level – Controls the resonance of the Mid A peaking filter band.
- Mid B Level – Controls the amount of boost or cut in the Mid B band.
- Mid B Frequency – Sets the center frequency of the Mid B peaking filter band.
- Mid B Level – Controls the resonance of the Mid B peaking filter band.
- Clean Mix – Controls the amount of clean signal on the output.
- Distortion Mix – Controls the amount of distorted signal on the output.
- Voice – Controls a midrange “voice” boost or cut that changes the character of the distortion.
- Voice Frequency – Sets the center frequency of the Voice control.

Effect Switch

Selects between the three basic Fuzz effect types – Heavy, Normal, or Octave. These effects are described in further detail in the [Effect Types](#) section.

LEDs

Engage / Bypass LED

The ENGAGE / BYPASS LED above the footswitch indicates if the Fuzz effect is active (lit green) or bypassed (not lit).

When the user preset mode is enabled, the LED will turn red. See the [Preset Storage and Recall](#) section for more information about user presets.

External Control LED

The small LED located between the Depth and Speed knobs is the EXTERNAL CONTROL LED. When lit, it indicates that external control mode (expression, hot hand, or MIDI) is active. For more information, see the [External Control](#) section.

Footswitch

Enables or bypasses the Fuzz effect.

Control Input Button

This small button is used when configuring external control. See the [External Control](#) section for more details.

Preset Storage and Recall

The Kingmaker features a user preset that can be easily saved and recalled using the footswitch. When a preset is recalled, all of the parameters instantly jump to their saved value, regardless of the position of the knobs. This allows you to save your favorite sound without having to worry about the knob positions.

Saving Your First Preset

- Bypass the Kingmaker by clicking the ON/OFF FOOTSWITCH once. The ENGAGE/BYPASS LED should be dark at this time.
- Press and hold the ON/OFF FOOTSWITCH for 5 seconds and wait for the ENGAGE/BYPASS LED to turn red. You are now in preset mode.
- Set up the effect how you want it to sound, including the EFFECT SWITCH, LEVEL KNOB, DRIVE KNOB, BASS KNOB, and TREBLE KNOB. Once you have made a change, the ENGAGE/BYPASS LED will begin to blink.
- To save your preset, hold the footswitch until the ENGAGE/BYPASS LED blinks rapidly 3 times.
- Now you can engage and bypass the Kingmaker using the ON/OFF FOOTSWITCH, and each time you engage the effect, your saved preset will be recalled.

Editing a Preset

- Activate your preset (the ENGAGE/BYPASS LED will be solid red).
- Change any parameter you wish (EFFECT SWITCH, LEVEL KNOB, DRIVE KNOB, BASS KNOB, and TREBLE KNOB). Once you have made a change, the ENGAGE/BYPASS LED will begin to blink.
- When you are ready to save, press and hold the ON/OFF FOOTSWITCH for a few seconds. The ENGAGE/BYPASS LED will blink three times to show that the preset was saved.

Exiting Preset Mode

- When Preset Mode is active, bypass the effect using the ON/OFF FOOTSWITCH. The ENGAGE/BYPASS LED should be dark at this time.
- Press and hold the ON/OFF FOOTSWITCH for 5 seconds and wait for the ENGAGE/BYPASS LED to turn green. You have now exited Preset Mode.

Universal Bypass™

Most effect pedals offer either true bypass or buffered bypass. The Kingmaker contains two separate circuits for bypass mode, allowing you to choose the method you prefer. The true bypass path uses signal relays, which are electromechanical switches. This provides an ultra-low resistance path from the input jacks to the output jacks, which is effectively the same as a wire. The buffered bypass path uses extremely low noise buffers, which provide a very low output impedance and are effective for driving long cables or long chains of effects following the Kingmaker's audio output.

Out of the box, the Kingmaker operates in true bypass mode. In order to switch to buffered bypass mode, edit the Kingmaker’s global settings using the Neuro App.

We recommend you choose between the active analog bypass (a.k.a. buffered bypass) and relay-based true bypass based on what is needed in your signal chain. Ideally, the first pedal in a signal chain is a buffered input followed by true bypass in the rest of the signal chain.

Both bypass methods have pros and cons associated with them. Buffered bypass provides consistent input impedance so that if the source is susceptible to variations in input impedance (similar to a guitar pickup), there won’t be a noticeable change in tone. True bypass has the benefit of providing a dedicated hardwired bypass signal path. The Kingmaker features small-signal relays for true bypass switching that offer reduced pops and clicks compared to the traditional true bypass switching method using a mechanical switch.

Stacking and Parallel Processing “Inside the Box”

The Kingmaker works great as a simple mono Fuzz effect, but it has the power to do much more. Within the Kingmaker, two completely independent overdrive, fuzz, or distortion circuits can be set up to run stacked (in series), in parallel (side-by-side and mixed), or even in true stereo. Usually, this would require two separate distortion pedals, but the Kingmaker can do it all on its own.

Stacking (Series / Cascaded)

Stacking overdrive, fuzz, and distortion pedals is a common method for creating unique textures that would not be possible with a single pedal. This normally involves putting two pedals in series, one after the other, to create multiple gain stages. Typically, this requires two separate distortion pedals, but the Kingmaker can do it all internally. Each of the two drive stages, called A and B, can be configured independently using any overdrive, fuzz, or distortion circuit, with its own independent settings (drive, level, EQ, noise gate). This routing option is designated as MONO IN/OUT WITH CASCADING CHANNELS in the Neuro App.

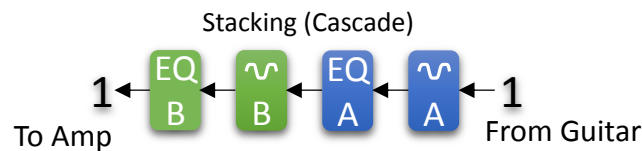

Parallel Processing

Another common way to create new and interesting distortion sounds is to split the guitar signal, run it to two independent pedals in parallel, and then combine (mix) the results. Often, one path will have a relatively low gain and the other will have high gain. This approach can combine high gain power and sustain with low gain clarity, definition, and articulation. The right balance can make parallel processing very effective. Usually this approach requires a lot of hardware: two distortion pedals, a splitter, and a mixer. The Kingmaker, however, can do it all internally. Each circuit has its own clean and drive level controls, which allow for very fine balancing between the two sounds. There are two parallel processing routing options available in the Neuro App: MONO IN STEREO PROCESS MONO OUT and MONO IN STEREO PROCESS STEREO OUT.

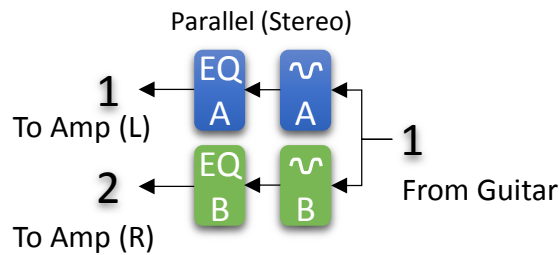
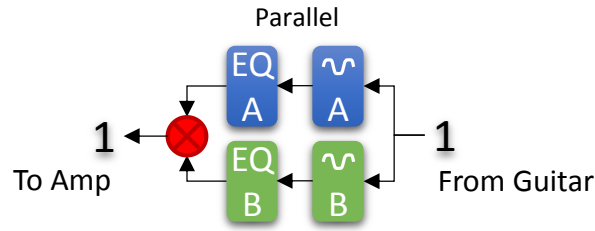

Series / Parallel Hybrid

By selecting the MONO IN/OUT WITH CASCADING CHANNELS routing option and bringing up the clean mix level on channel B, it's possible to create a series/parallel hybrid sound, as shown in the image below:

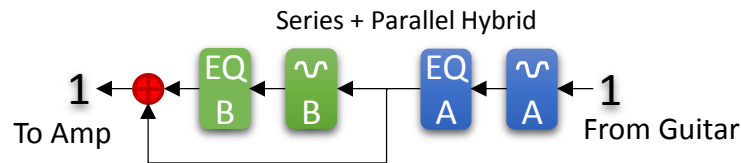

Stereo Routing

The Kingmaker works great as a mono Fuzz effect, but its stereo inputs and outputs also make it a true stereo effect as well as a flexible signal router. It can act as a stereo splitter, merger, or true stereo effect, and it can also be set up in a number of other unique signal routing modes. By default, the Kingmaker works in true stereo mode (INPUT 1 goes to OUTPUT 1, and INPUT 2 goes to OUTPUT 2). To configure a different stereo routing mode, use the Neuro App.

A few different routing options are displayed below. The right side of each diagram shows inputs 1 and 2, the left side shows outputs 1 and 2, and the distortion and EQ circuits (labeled A and B) are in the center.

Mono (Default – Auto Select): INPUT 1 goes to distortion circuit A and out to OUTPUT 1.

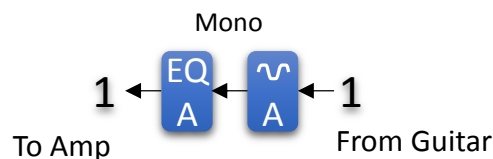

True Stereo (Stereo In, Stereo Out): INPUT 1 goes to distortion circuit A and out to OUTPUT 1. INPUT 2 goes to distortion circuit B and out to OUTPUT 2.

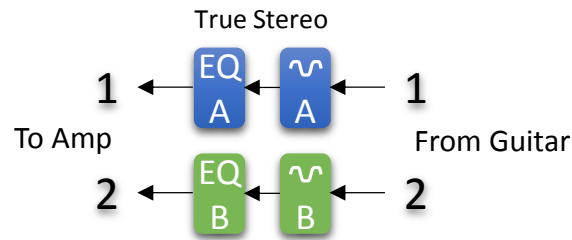

Parallel (Mono In, Stereo Process, Stereo Out): INPUT 1 is split into two identical signals. One signal goes to distortion circuit A and out to OUTPUT 1. The other signal goes to distortion circuit B and out to OUTPUT 2. This essentially turns the Kingmaker into a splitter that takes a single input and feeds two amps (or a stereo signal chain).

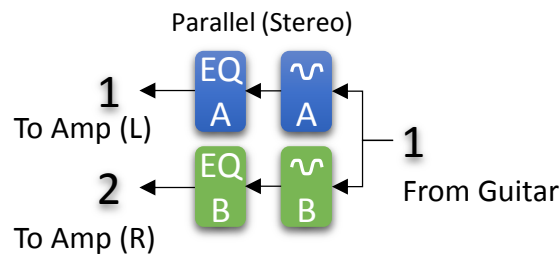

Stereo In, Mono Out: INPUT 1 goes to distortion circuit A. INPUT 2 goes to distortion circuit B. The outputs of circuits A and B are mixed and sent to OUTPUT 1. This is useful for mixing a stereo source down to a mono output.

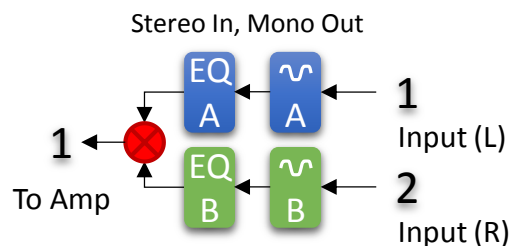

Mono, Dry Thru: INPUT 1 goes to distortion circuit A and out to OUTPUT 1. A copy of the input is also sent to OUTPUT 2. This is useful especially for bass guitars, where having a dry output is useful in maintaining a solid low end (this can also be achieved using the Kingmaker’s mix control or LoRetain feature, which are accessible via the Neuro app and MIDI).

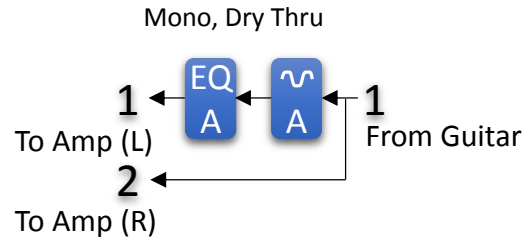

External Loop Pre-Effect: The external loop options allow an external effect (whether a Source Audio product or a third-party product) to be connected to the Kingmaker’s INPUT 2 and OUTPUT 2. When the Kingmaker is bypassed, the external effect will be out of the circuit. When the Kingmaker is enabled, the external effect will be put in series with the Kingmaker’s distortion circuit. OUTPUT 2 should connect to the external effect’s input, and the external effect’s output should connect to INPUT 2.

In Pre-Effect mode, the guitar signal will go to the external effect first, and then the Kingmaker’s distortion circuit second.

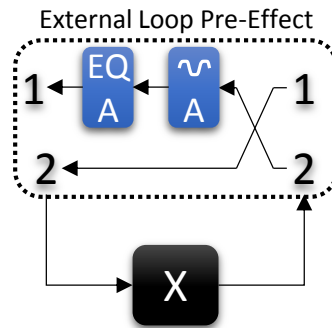

In Post-Effect mode, the guitar signal will go to the Kingmaker’s distortion circuit first, and then to the external effect second.

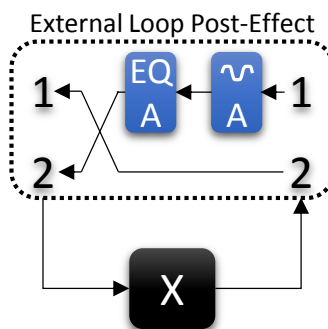

Automatic Routing Mode Selection

By default, the routing mode is automatically chosen. The cables connected to the inputs and outputs are detected and the mode is set according to the below table:

Input(s)	Output(s)	Routing Mode
1 only	1 only	Mono Input, Mono Output
1 and 2	1 only	Stereo Input, Stereo Parallel Processing, Sum to Mono Output
1 only	1 and 2	Mono Input, Stereo Parallel Processing, Stereo Output
1 and 2	1 and 2	Stereo Input, Independent Stereo Processing, Stereo Output

Check the Neuro App for more details on routing options.

Parametric EQ

The Kingmaker features two built-in 4 band parametric EQs that can be configured using the Neuro App. Different EQ settings can be saved for each of the three effect types, as well as for the user preset. The EQs consist of four independently configurable bands:

- **Bass (Band 1):** Low Shelf
- **Mid A (Band 2):** Peaking (a.k.a. Bell / Band)
- **Mid B (Band 3):** Peaking (a.k.a. Bell / Band)
- **Treble (Band 4):** High Shelf

Each band has configurable frequency, boost/cut, and Q (bandwidth).

A simple example of these four bands in action is shown in the graph below. In this example, Band 1 is a low shelf filter at 100 Hz with a 6 dB cut, Band 2 is a peaking filter at 620 Hz with a 3 dB cut and relatively high Q, Band 3 is a peaking filter at 3 kHz with a 1.5 dB boost and relatively low Q, and Band 4 is a high shelf filter at 10 kHz with a 2.5 dB cut.

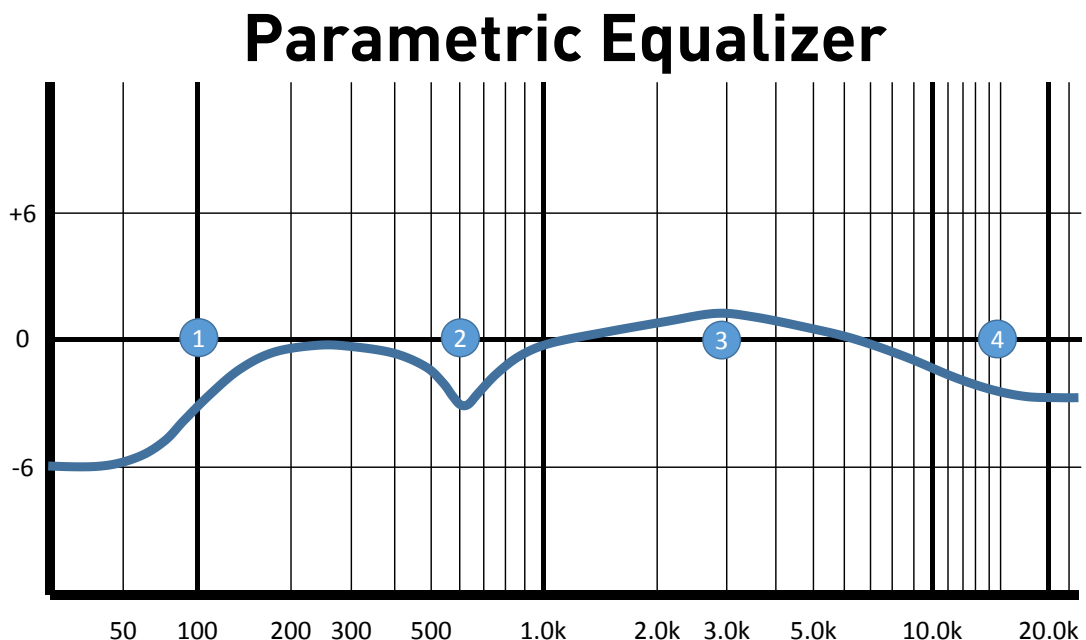

By default, Band 1 is a shelf when it is boosted (gain > 0 dB) and a high pass when it is cut (gain < 0 dB). By default, Band 4 is a shelf when it is boosted (gain > 0 dB) and a low pass when it is cut (gain < 0 dB). Using the Neuro App, Bands 1 and 4 can optionally be configured as shelves when cutting (gain < 0 dB), with optional values for slope and rolloff.

The left channel and right channel can each have unique boost/cut values for each of the 4 bands. However, the filter types and cutoff frequencies (or center frequencies) must be the same for both channels.

The physical BASS KNOB and TREBLE KNOB directly control the boost or cut of the parametric EQ's bass and treble bands.

Low Cut Filter

The Kingmaker also includes a stereo low cut filter (a.k.a. high pass filter) with an adjustable frequency. This filter is very useful for cutting out low frequencies that do not contribute to the sound of the instrument, as well as subsonic frequencies which cannot be heard at all. Bass players often use low cut filters set very low (around 10 Hz to 30 Hz) to reduce speaker excursion and improve the clarity of the bass. Guitarists often use low cut filters set somewhat higher (around 80 Hz) in order to give the bass player additional room in the low end of the mix. The filter is second-order and attenuates signals by approximately 12 dB per octave or 40 dB per decade.

Configurable Low Cut Filter

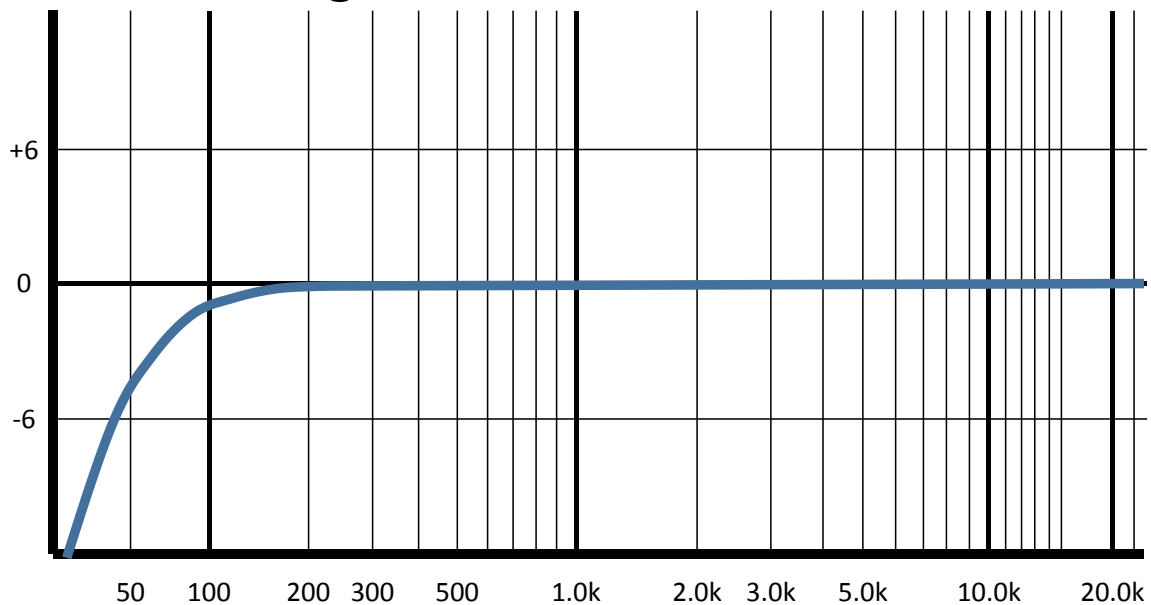

The Parametric EQ and the Low Cut filter are configurable using the Neuro App. By default, the parametric EQ is disabled (flat), and the Low Cut filter is set to 10 Hz.

LoRetain

LoRetain is a technique used by Source Audio to maintain a solid low end even with high amounts of distortion. This is particularly useful for bass players or extended-scale guitar players (7-string and 8-string guitars) that need to maintain a strong fundamental while keeping high drive on the upper frequencies. LoRetain is available as a control in the Neuro App independent of the parametric EQ and low cut filter.

Voice Control

Each overdrive/fuzz/distortion circuit features a VOICE control that is a gradual timbre adjustment affecting the overall character of the sound. It generally affects the midrange in subtle ways, so a high VOICE setting will generally provide a midrange boost, whereas a low VOICE setting will provide a midrange cut. Many different sounds are available using the VOICE control, which can be controlled via the Neuro App.

Noise Gate

Overdrive, fuzz, and distortion effects introduce a lot of gain into the signal chain, and this gain amplifies not just the guitar signal, but also any noise present in the system. As a result, overdrive, fuzz and distortion effects tend to increase the amount of noise in the signal chain, especially when the guitar is silent or playing at very low levels. In order to correct this problem, guitarists often use noise gates prior to the distortion stages in their signal chains. The Kingmaker includes a built-in noise gate to help reduce noise and preserve the guitar signal. The noise gate consists of a traditional gain reduction circuit as well as a filter gate, which works by attenuating high noisy frequencies when necessary. By default, the noise gate is not active. The volume gate and filter gate can independently be enabled and configured using the Neuro App. The gate will automatically be linked in stereo modes or independently configured in stacking and parallel modes.

External Control

The CONTROL INPUT port opens up a wide array of external control options, allowing for direct control over many of the Kingmaker's built-in parameters. It can be used as an expression input or as a data port for the Neuro Hub.

Expression Control

The Kingmaker's effects parameters can be controlled directly by an expression pedal or Hot Hand connected to the CONTROL INPUT port. By default, an expression pedal controls the amount of Drive.

Expression Pedal Input

The Dual Expression Pedal or Reflex Universal Expression Pedal, both from Source Audio, can be directly connected to the CONTROL INPUT using a 3.5 mm, TRRS cable.

In the case of an expression pedal with a TRRS plug, like Source Audio's expression pedals, the tip connection is power, the first ring is the X axis expression signal, the second ring is the Y axis expression signal, and the sleeve connection is ground.

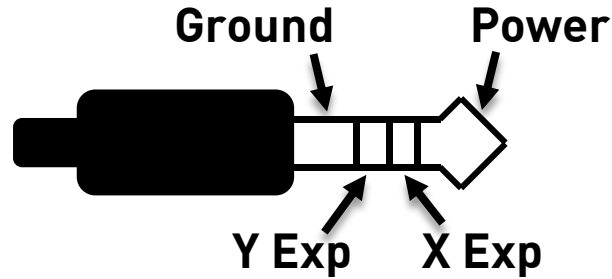

Third party passive expression pedals can be used as well, as long as they have a TRS (Tip Ring Sleeve) plug with power on the tip, expression (the wiper of the potentiometer) on the ring, and ground on the sleeve, as seen in the diagram below.

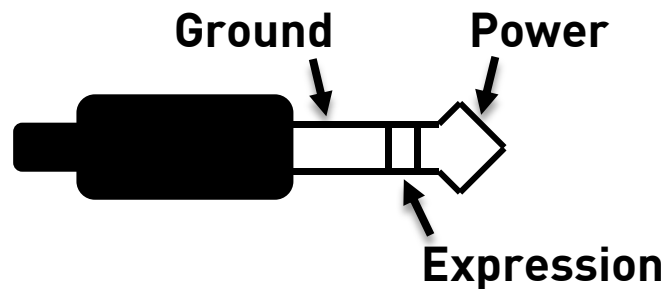

Expression pedals with TS (Tip Sleeve) plugs will not work correctly with the Kingmaker.

The resistance of the expression pedal does not matter. The Kingmaker will automatically adjust itself to the range of the expression pedal when it is configured.

Most expression pedals use a 1/4" plug, but the Kingmaker's CONTROL PORT is 3.5 mm. To make the connection, a simple TRS plug converter (1/4" to 3.5 mm) can be used.

Note that although the CONTROL INPUT expects a 4-contact TRRS plug, most 3rd party expression pedals use a 3-contact TRS plug. This is OK – using a simple 3-contact TRS plug converter, the expression pedal's output will be connected to the Kingmaker's CONTROL INPUT and the extra contact is ignored. For proper operation, the configuration steps in the next section must be followed when using any expression pedal, whether from a third party or from Source Audio.

Configuring the Expression Pedal

It is easier than ever to set up expression control using the Kingmaker's new calibration and mapping method. When the expression pedal is connected to the Kingmaker, follow these simple steps to calibrate it and map it to control different effect parameters.

1. Press the CONTROL INPUT button to turn on Control Input mode. The CONTROL LED should be lit green.
2. Press and hold the CONTROL INPUT button until the CONTROL LED begins to blink slowly (approximately one blink per second).
3. Move the expression pedal over the range of motion you would like to use to control the Kingmaker. If you would like to use the expression pedal's full range of motion, then make

sure to move the pedal all the way from its minimum position to its maximum position. Note that you can create “dead zones,” if desired, by only moving the expression pedal over a limited region of its full range of motion.

4. After setting the expression pedal range, click the Kingmaker’s footswitch once. The calibration is now complete, and the CONTROL LED will blink faster (about 2 blinks per second). Now, it is time to map the expression pedal to the effect parameters.
5. Move the knob(s) you wish to control with the expression pedal to the minimum desired position, then click the Kingmaker’s footswitch. The CONTROL LED will now blink even faster (about 4 blinks per second). Note that you may control one or more knobs with the expression pedal, up to four total knobs.
6. Move the knob(s) you wish to control with the expression pedal to their maximum desired position, then click the footswitch. The CONTROL LED will now be lit solid green. Note that you may control one or more knobs with the expression pedal, up to four total knobs.
7. After setting the minimum and maximum knob positions, the parameter mapping is complete.

Note: The parameter range can be inverted by swapping the minimum and maximum position of the knobs during configuration.

External Switch used as Expression Input (Expression “Toggle”)

An external switch can also work as a sort of expression pedal that only has two positions: on and off. The external switch can be either momentary or latching.

To use this mode, connect an external switch to CONTROL INPUT. The following plug configuration is required:

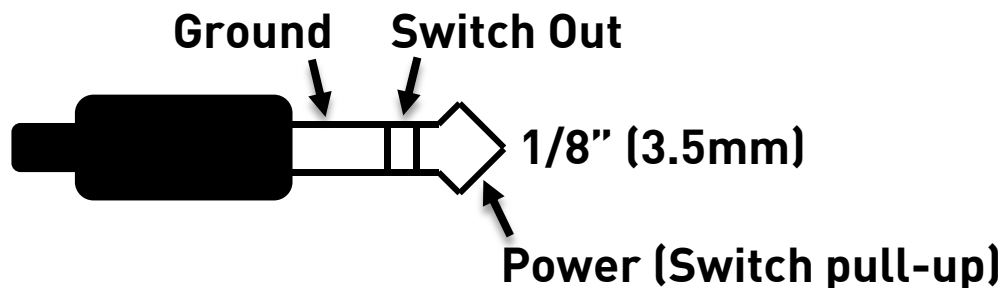

Follow these steps for configuration:

1. Press the CONTROL INPUT BUTTON to enable external control. The CONTROL LED should be lit red.
2. Press and hold the CONTROL INPUT BUTTON until the CONTROL LED begins to blink slowly (approximately one blink per second).
3. Tap the external switch once.
4. Click the ON/OFF FOOTSWITCH once. The CONTROL LED will blink faster (about 2 blinks per second). Now, it is time to map the external switch to the effect parameters.
5. Move the knob(s) you wish to control with the external switch to the maximum desired position, then click the ON/OFF FOOTSWITCH. The CONTROL LED will now blink even faster

(about 4 blinks per second). Note that you may control one or more knobs with the external switch, up to six total knobs.

6. Move the knob(s) you wish to control with the expression pedal to the minimum desired position, then click the ON/OFF FOOTSWITCH. The CONTROL LED will now be lit solid red.
7. After setting the minimum and maximum knob positions, the parameter mapping is complete.

Hot Hand Input

The Hot Hand 3 Wireless Effects Controller can be connected directly to the Kingmaker's CONTROL INPUT for motion control of the Kingmaker's effects parameters. The Hot Hand has two axes of expression: X and Y. These signals are carried on the two rings of the TRRS cable that comes from the Hot Hand receiver.

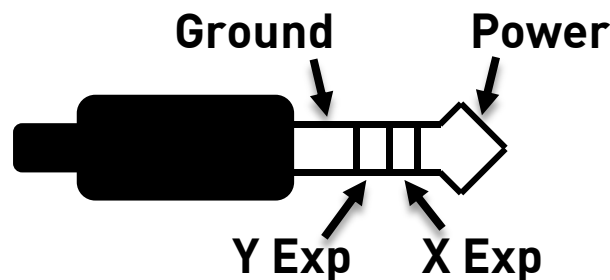

Configuring the Hot Hand

When the Hot Hand is connected to the Kingmaker, follow these simple steps to calibrate it and map it to control different effect parameters.

1. Press the CONTROL INPUT BUTTON to turn on Control Input mode. The CONTROL LED should be lit green.
2. Press and hold the CONTROL INPUT BUTTON until the CONTROL LED begins to blink slowly (approximately one blink per second).
3. Move the Hot Hand ring over the range of motion you would like to use to control the Kingmaker. The easiest way to do this is to move the ring in the same way that you intend to move it as you perform. The Kingmaker will intelligently select the X or Y axis of the Hot Hand automatically, based on the motion of the ring.
4. After setting Hot Hand range of motion, click the Kingmaker's ON/OFF FOOTSWITCH once. The calibration is now complete, and the CONTROL LED will blink faster (about 2 blinks per second). Now, it is time to map the Hot Hand to the effect parameters.
5. Move the knob(s) you wish to control with the Hot Hand to their minimum desired position, then click the Kingmaker's ON/OFF FOOTSWITCH. The CONTROL LED will now blink even faster (about 4 blinks per second). Note that you may control one or more knobs with the Hot Hand, up to four total knobs.
6. Move the knob(s) you wish to control with the Hot Hand to their maximum desired position, then click the Kingmaker's ON/OFF FOOTSWITCH. The CONTROL LED will now be lit solid green. Note that you may control one or more knobs with the Hot Hand, up to four total knobs.

- After setting the minimum and maximum knob positions, the parameter mapping is complete.

Note: The parameter range can be inverted by swapping the minimum and maximum position of the knobs during calibration.

Reset Expression Control Mapping

To clear the expression control mapping (Expression or Hot Hand), first press the CONTROL INPUT BUTTON and turn off Control Input mode. The CONTROL LED should be dark. Then, press and hold the CONTROL INPUT BUTTON until the CONTROL LED blinks. This clears all Expression, Hot Hand, and MIDI mapping.

Neuro App

The Neuro App is available as a free download for iOS and Android devices. Get the iOS version from the App Store or the Android version from the Play Store. The Neuro App provides access to a number of parameters that are not accessible on the control knobs, as well additional effect types. In order to use the Neuro App, use the included 3.5 mm to ¼" TRS cable to make a connection between the headphone jack on your mobile device and the Input 2 jack on the hardware. The Neuro App uses special audio signals sent over your mobile device's headphone jack to remotely control the pedal. Make sure the headphone volume on your mobile device is set to maximum when using the Neuro App for the most reliable device to pedal communication.



Main Menu

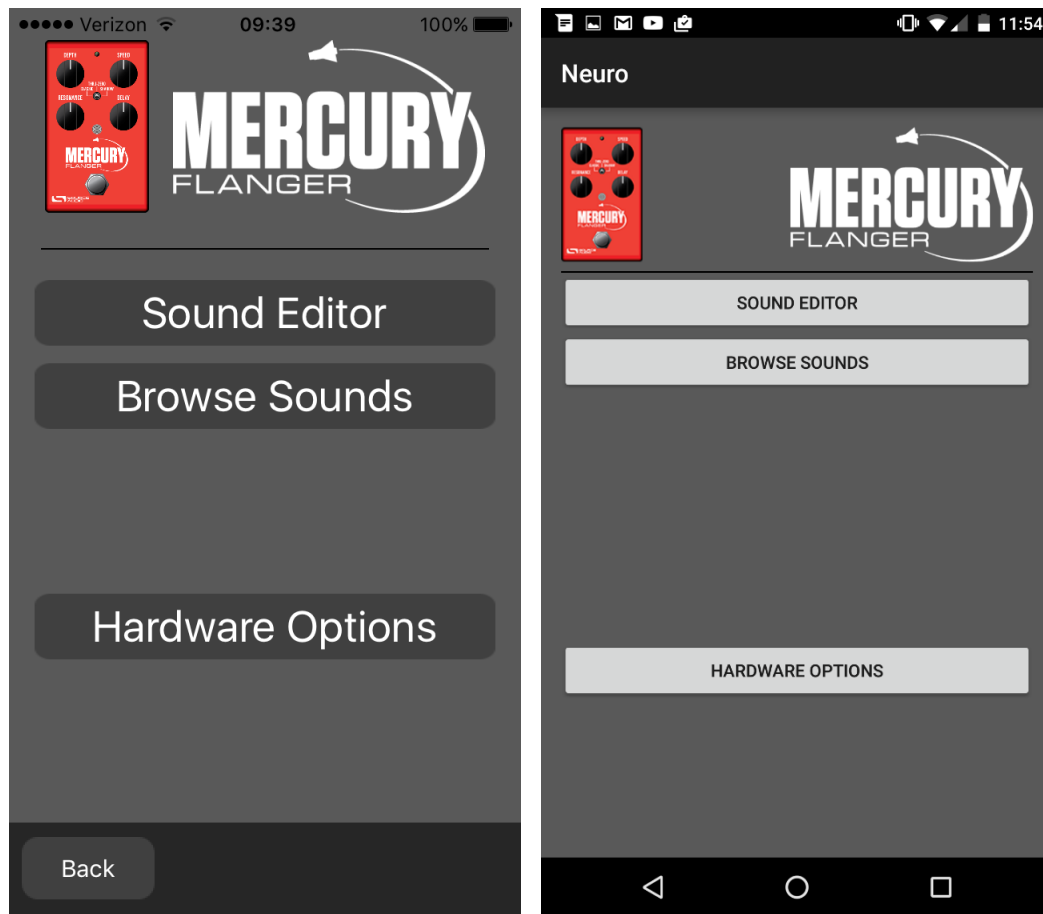

The main menu includes links to the three main sections of the app:

- Sound Editor allows the user to edit the current effect or create a new sound from scratch. These sounds can be burned into the internal preset memory (three sounds corresponding to the three positions of the effect selector switch, and an additional preset accessible via the footswitch), saved to a preset file in the app, emailed to friends, posted to the Neuro Community site, and more.
- Browse Sounds opens a library of sounds to choose from, divided into User, Factory, Published, and Web categories. This is a place to organize and share your favorite settings. You can also explore sounds and settings made by other users.
- Hardware Options allows access to the global options for the hardware. Global options are “set and forget” type settings that are NOT saved per preset.

Sound Editor

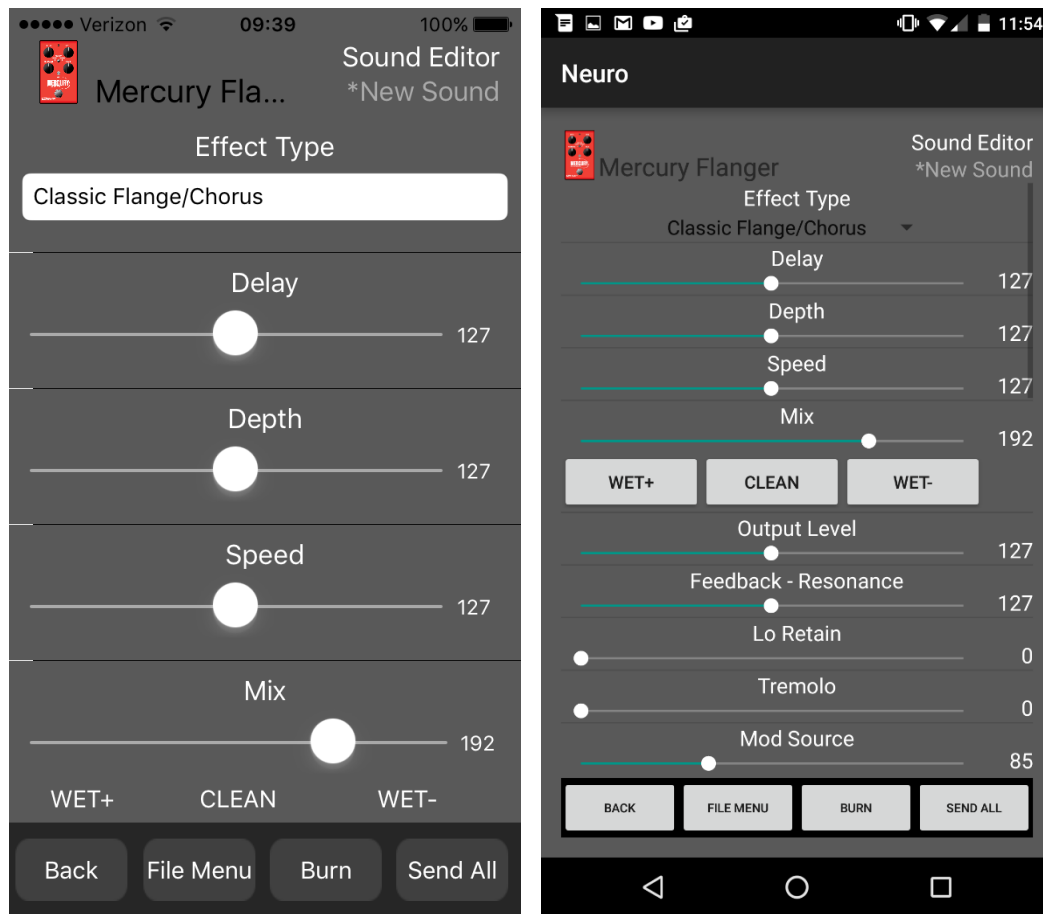

The Sound Editor displays a wide range of parameters that can be changed to create different sounds. The Sound Editor works kind of like a remote control for a TV – only the parameters you touch on the screen will be modified on the hardware; all other parameters remain unchanged.

The links at the bottom of the screen allow access to the File Menu, the Burn command, and the Send All command.

Send All

If you wish to update all of the parameters on the hardware so that they match what is shown on the Sound Editor screen, tap the Send All button. This sends every parameter setting over to the hardware and guarantees that its settings will exactly match what is shown in the app.

File Menu

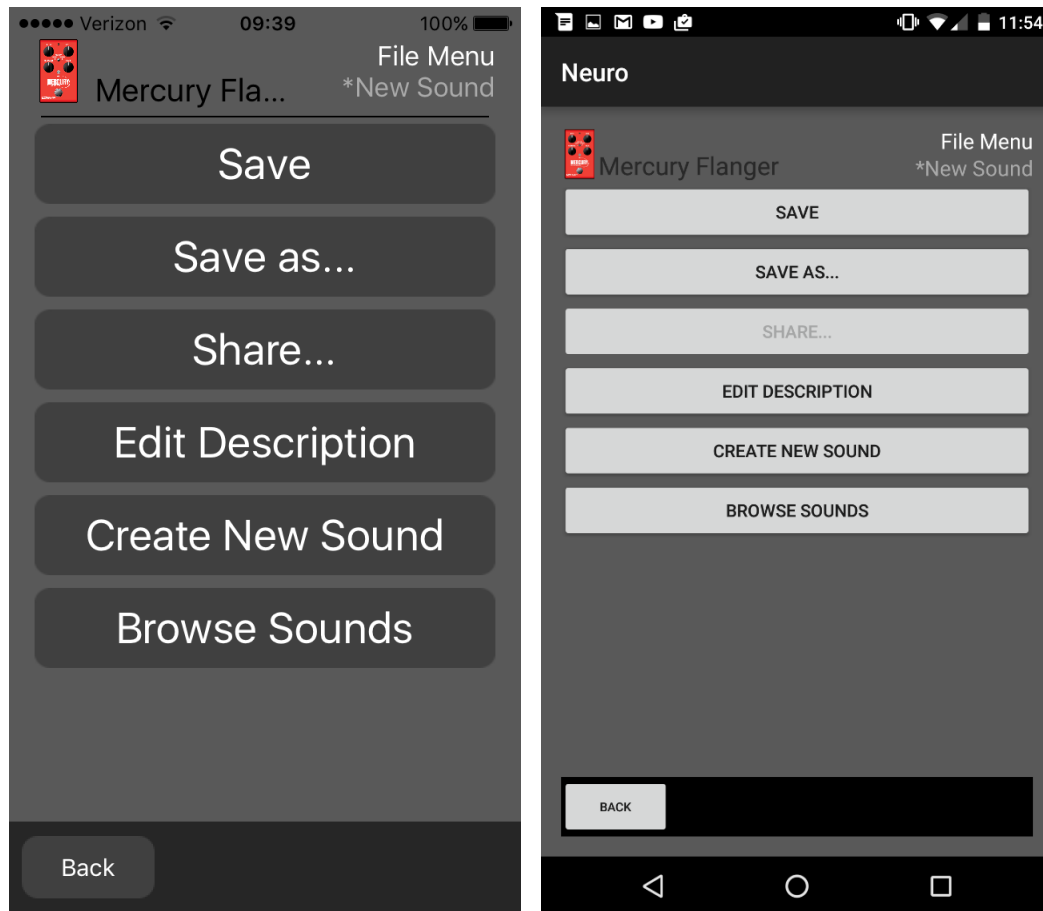

The File Menu displays different options for the sound you're currently editing in the Sound Editor.

Save

Saves the current settings from the Sound Editor. If you haven't saved yet, this will perform a Save As.

Save As

Allows you to save the current settings to a new file. You can choose a file name and description.

Share

Allows you to send the current settings to a friend as a text message or email attachment.

Edit Description

Edits the description that accompanies the preset in the Browse Sounds menu.

Create New Sound

Closes the current sound being edited and opens a new sound for editing with default settings.

Browse Sounds

Returns to the Browse Sounds screen, which displays a list of user and web presets.

Burn

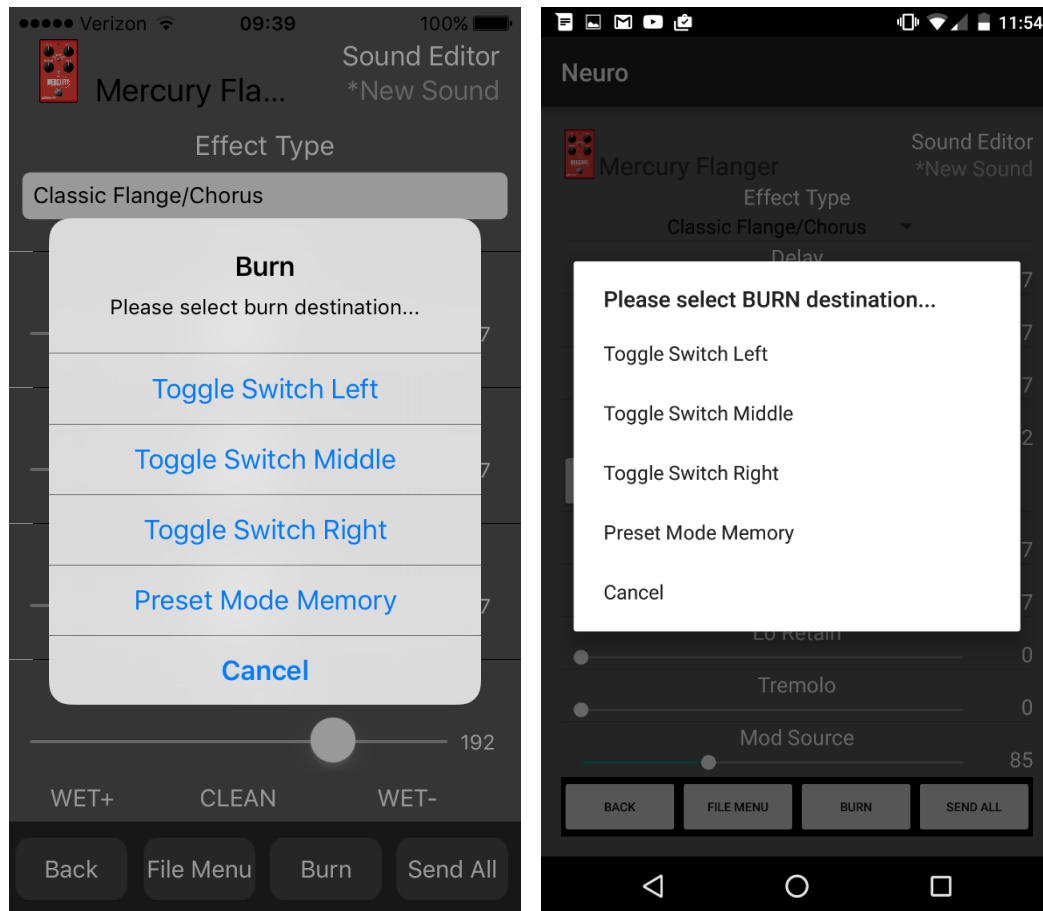

The Burn command takes the current sound that is running in the hardware and “burns” it to the internal memory for later use. Burn works as a “what you hear is what you get” type of control; it will save all of the settings in their current state, as you hear them, and put those into memory. This will not necessarily match the exact settings shown in the Sound Editor for all parameters **unless** you have performed a [Send All](#) command first.

After selecting the Burn command, a list of target locations in memory is displayed. There are a total of 4 options: the 3 factory slots that correspond to the effect selector switch, and the 1 slot in preset memory.

Replacing an Effect on the Effect Switch

It is possible to replace one of the main effect types with one of the extended effect types or with a user-created sound. To do this, follow these steps:

- Load the sound in the Sound Editor.
- Hit the Send All button.
- Hit the Burn button.
- Select one of the Effect Selector Switch positions to overwrite it.

Browse Sounds

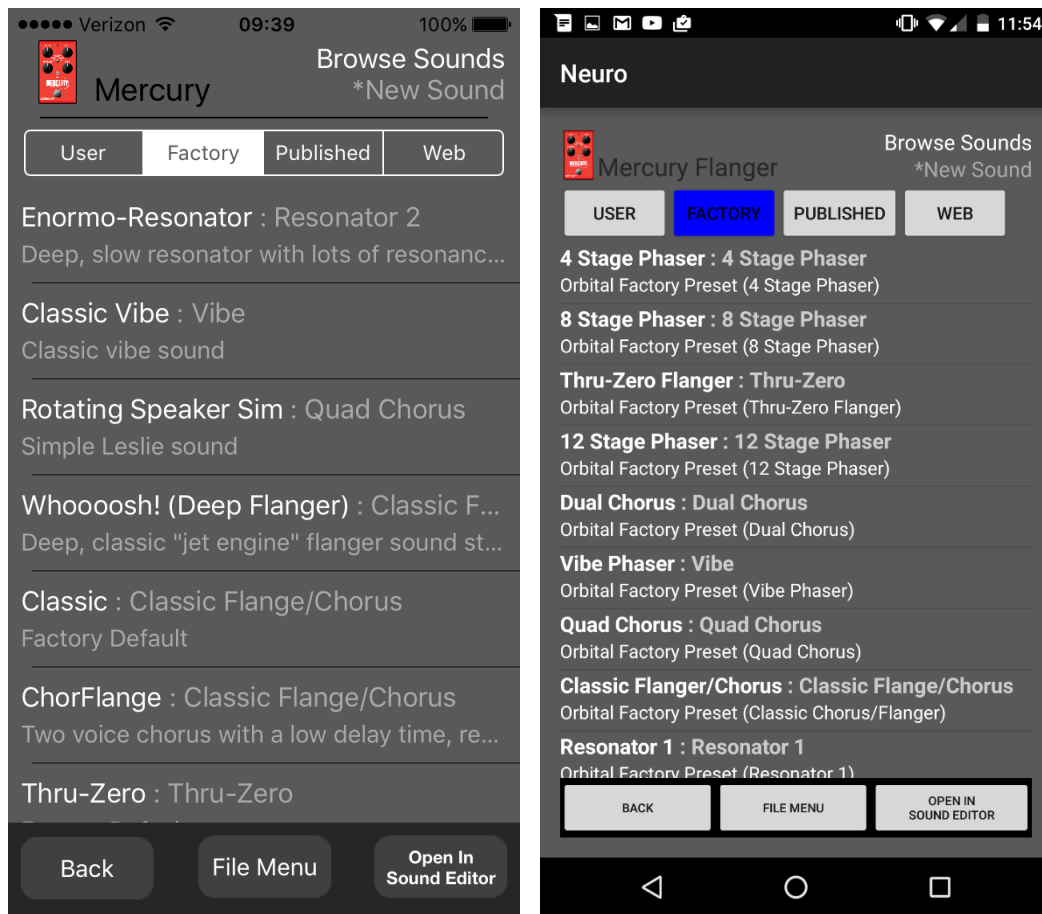

The Browse Sounds screen displays lists of presets that can be easily loaded into the hardware. Just tap on a preset name to send it to the hardware, and you should be able to hear it instantly.

Presets are divided into four sections:

- **User:** Presets that you have created and saved.
- **Factory:** Presets that were created by Source Audio. New presets will automatically be added to this list as Source Audio creates them.
- **Published:** Presets that you have created and uploaded to the Neuro Community for other users.
- **Web:** Presets created and shared by other users.

Open In Sound Editor

The Open In Sound Editor button allows you to take the currently selected preset and open it in the Sound Editor for editing and customization.

Deleting or Publishing Presets

Swipe to the left on any preset name for additional options. Tap DELETE to remove the preset from your device. Tap PUBLISH to publish the preset – this lets other Neuro users enjoy your creation!

Hardware Options

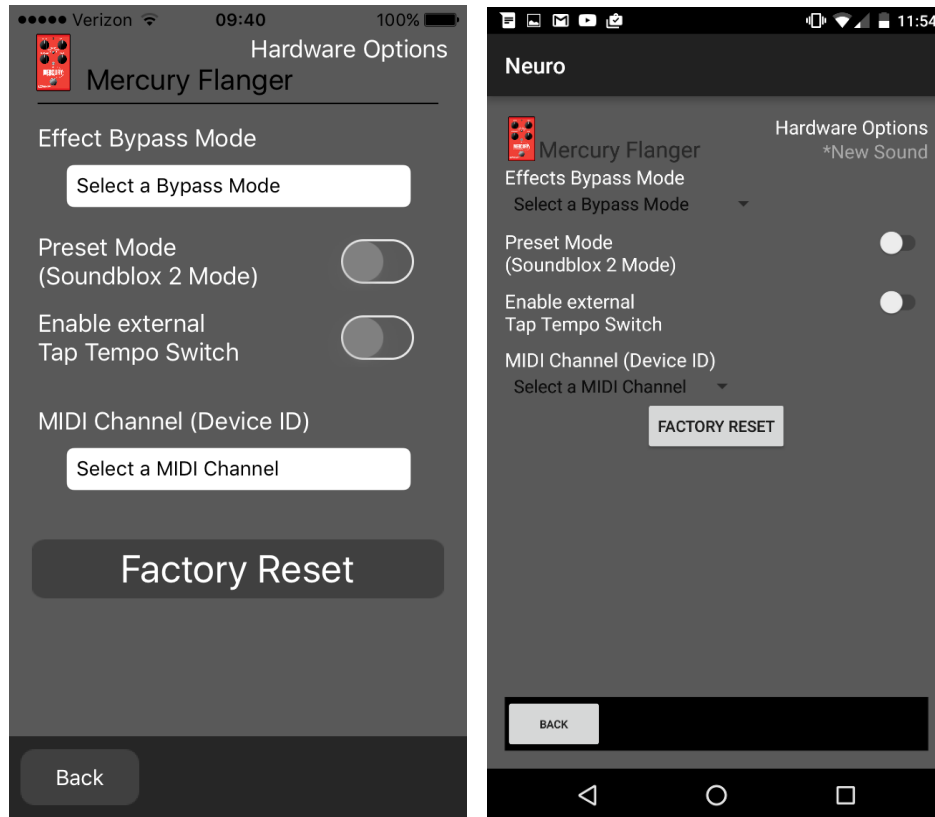

This screen shows some advanced options.

Effect Bypass Mode

Selects which bypass path will be used for presets that use hardware bypass mode.

- True Bypass (Relay) uses two relays for true bypass switching.
- Active Analog (Buffered) bypass uses a buffer to help prevent signal loss and clicking.

MIDI Channel (Device ID)

Selects which channel (1 to 16) the hardware will respond to on Hub and USB-MIDI inputs. Note that some manufacturers begin counting MIDI channels at zero (from 0 to 15), while the Source Audio Neuro App uses the convention of counting from 1 to 16.

Preset Mode (Soundblox 2 Mode)

Enables the preset saved in memory to be loaded each time the effect is enabled using the footswitch. This loads all settings from the preset and ignores the knob positions. When Preset Mode is enabled, the main LED will be red instead of green. Preset Mode can also be enabled/disabled by pressing and holding the footswitch for a few seconds.

Factory Reset

Resets the internal memory (including all presets and effect types) to the factory default settings.

Quick Preset Mode

Allows preset mode to be enabled/disabled in 0.8 seconds instead of 5 seconds (by holding down the footswitch).

Example Neuro Daisy-Chain Connections

Mono Audio Path with Neuro Daisy-Chain

In the case of a purely mono audio signal path, the Neuro data can be input to the first effect directly from the mobile device and then carried on to the second effect via TRS cable.

Source Audio makes couplers that are designed specifically for connecting multiple One Series products in series. These couplers are available on the [Source Audio Online Store](#).

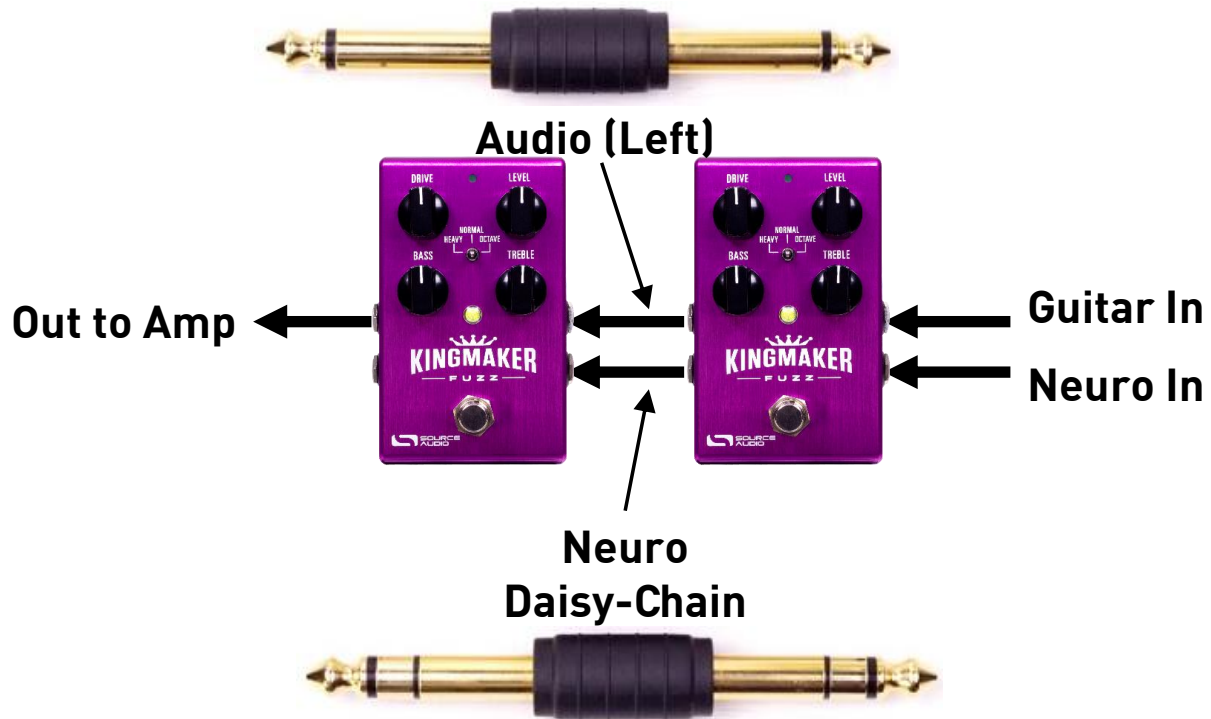

Mono-To-Stereo Audio Path with Neuro Daisy-Chain

In the case of a signal path that splits a mono input to stereo outputs, the Neuro data can be input to the first effect directly from the mobile device and then carried on to the second effect via TRS cable. The audio signal is carried on the same cable.

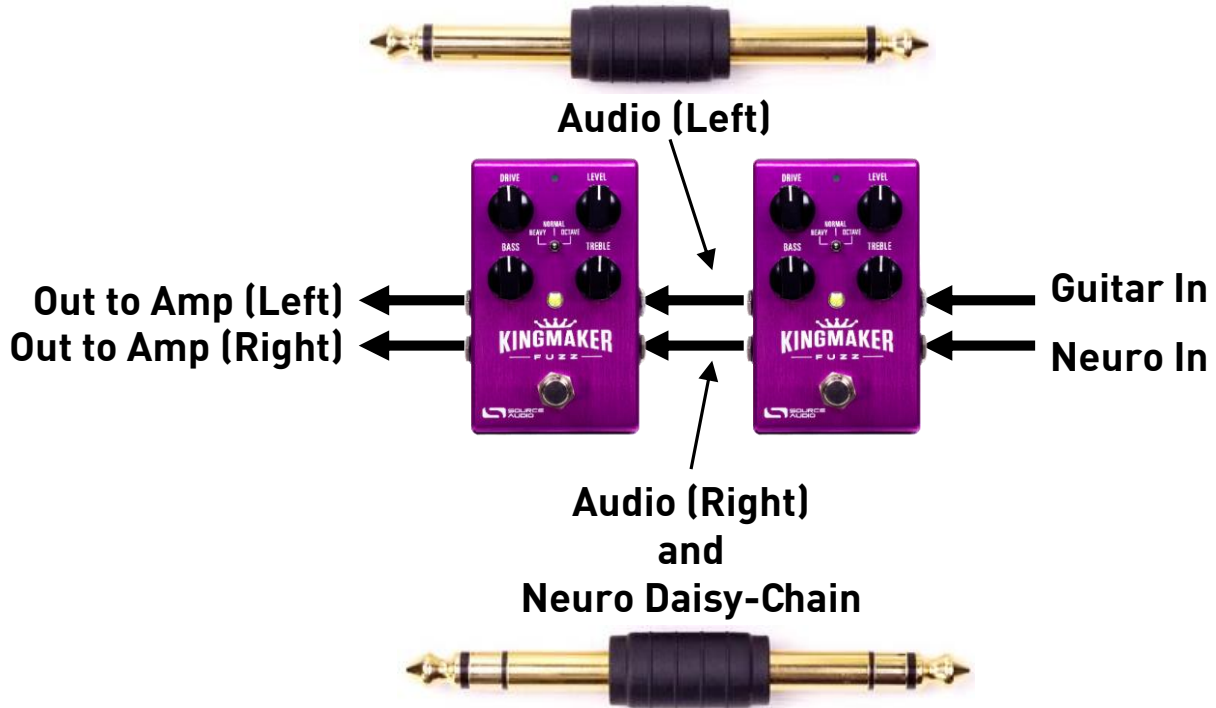

Neuro Hub (Formerly the Soundblox Hub)

The Source Audio Neuro Hub (sold separately), unites Source Audio pedals from the Soundblox 2 and One Series families to create a single, stage-ready system. It features shared MIDI, passive expression pedal input, Hot Hand connectivity, and USB, and can connect to up to five Source Audio pedals. The Neuro Hub features a powerful scene saving functionality, which allows you to create up to 128 multi-pedal presets known as scenes, each recallable via MIDI program change messages. Connect the Neuro Hub to your computer via USB for updates, saving and editing multi-pedal presets, and more. To connect the Kingmaker to the Neuro hub, use a 3.5 mm TRRS cable and make a connection between the Kingmaker's CONTROL INPUT jack and any of the Neuro Hub's multi-function outputs. For more information, refer to the Neuro Hub documentation on the Source Audio website.

MIDI

Using a USB connection or the Neuro Hub (sold separately), the Kingmaker can be controlled by generic MIDI messages. Each of the Kingmaker's parameters (even those that are not assigned to a control knob) is directly accessible via MIDI continuous controller messages. MIDI messages can be sent directly via USB or forwarded on to the Kingmaker via the Neuro Hub.

MIDI Learn

MIDI Continuous Control messages

In order to assign a MIDI continuous controller to one of the four knobs, the EFFECT SELECTOR SWITCH, or the ON/OFF FOOTSWITCH, follow these steps:

1. Press the CONTROL INPUT button to turn on CONTROL INPUT mode. The CONTROL LED should be lit green.
2. Press and hold the CONTROL INPUT button until the CONTROL LED begins to blink slowly (approximately one blink per second).

3. Send a MIDI continuous control message to the Kingmaker via USB or the Neuro Hub. When a valid continuous control message is received, the CONTROL LED will begin to blink faster (about two blinks per second).
4. To assign this continuous controller to a knob, turn the corresponding knob. To assign it to the ON/OFF FOOTSWITCH, press the ON/OFF FOOTSWITCH. To assign it to the EFFECT SELECTOR SWITCH, toggle the effect type switch.
5. Once the MIDI continuous controller has been assigned, the CONTROL LED will be solid green. This shows that the mapping was successful. **Note:** The CONTROL LED blinks any time a MIDI message is received, so it's possible that the CONTROL LED will continue blinking even after the MIDI mapping is complete – this shows that MIDI messages are still being sent to the Kingmaker.

For parameters like drive and level, which are normally controlled by knobs, the full range of continuous control values from 0 to 127 will be mapped to the range of the knob.

For the ON/OFF FOOTSWITCH, continuous control values in the range from 0 to 63 will bypass the Kingmaker and values in the range from 64 to 127 will enable the Kingmaker.

For the EFFECT SELECTOR SWITCH, continuous control values map directly to each effect type. See the [FAQ](#) for details.

Any MIDI CC, from 0 to 127, can be mapped to a control on the Kingmaker.

Each CC number can only be mapped to control one parameter at any given time. If you attempt to map a CC that has already been assigned to another parameter, the previous mapping will be overridden.

Several CCs can potentially be mapped to the same parameter, although this is not very useful.

When using MIDI Learn, the Kingmaker listens for the first MIDI CC message sent to it and then ignores any subsequent CC messages until the mapping is complete. This means that you must make sure that only send the MIDI CC message to the Kingmaker that you intend to use for the MIDI Learn mapping. Some DAWs send multiple MIDI messages when the play or pause buttons are pressed, and this can lead to unintended MIDI mappings. Check your DAW documentation in order to learn about messages that are sent at the beginning or end of playback.

Reset MIDI Mapping

To clear MIDI mapping, first press the CONTROL INPUT button and turn off Control Input mode. The CONTROL LED should be dark. Then, press and hold the CONTROL INPUT button until the CONTROL LED blinks. This clears all Expression, Hot Hand, and MIDI mapping.

MIDI Channel

By default, the Kingmaker responds to MIDI Channel 1. The Kingmaker ignores all MIDI messages sent to it that are not on its assigned channel. To change the Kingmaker's MIDI channel, edit the Kingmaker's global settings using the Neuro App. Note that some manufacturers begin counting MIDI channels at zero (from 0 to 15), while the Source Audio Neuro App uses the convention of counting from 1 to 16.

MIDI Clock

Since the Kingmaker has no time-dependent parameters, it will ignore MIDI clock.

USB

The Kingmaker's USB port is plug-and-play ready for Windows and Mac computers. The Kingmaker uses class-compliant drivers, so no special drivers are needed. Just power up the Kingmaker and connect it to the computer using a USB cable. The computer should automatically recognize the Kingmaker, which will be identified as "Source Audio One Series" in the operating system.

USB connectivity brings many benefits, such as the ability to download firmware updates to the Kingmaker, configuration of advanced parameters, accessing new effect types created by the Source Audio engineers, and MIDI connectivity to audio production software running on the computer.

USB-MIDI

The Kingmaker will appear as a MIDI device in your computer's operating system. As a result, the Kingmaker can communicate with audio production software that utilizes MIDI, such as Pro Tools, Ableton Live, Logic Pro, and more. MIDI messages can be sent directly to the Kingmaker using the USB connection, which allows for full automation of the Kingmaker within host software such as a DAW. For example, the drive level can be automated by outputting MIDI continuous controller messages from the host software to the Kingmaker via the USB connection.

Specifications

Dimensions

- Length: 11.63 cm (4.58 inches)
- Width: 7.00 cm (2.75 inches)
- Height (not including knobs and footswitch): 3.71 cm (1.46 inches)
- Height (including knobs and footswitch): 5.61 cm (2.21 inches)

Weight

- 280 grams (0.625 pounds)

Power

- 180 mA @ 9V DC (max 220 mA with Hot Hand Wireless Adapter)
- Negative tip (positive sleeve) barrel power jack, 2.1 mm inner diameter, 5.5 mm outer diameter

Audio Performance

- Maximum Input Level: +6 dBV = 8.2 dBu = 2 V RMS = 5.6 V p-p
- Input Impedance: 1 MegaOhm (1 MΩ)
- Output Impedance: 600 Ohm (600 Ω)
- 108 dB DNR Audio Path
- 24-bit Audio Conversion
- 56-bit Digital Data Path
- Universal Bypass™ (relay-based true bypass and analog buffered bypass)

Troubleshooting

General

Restore factory settings: In order to revert the Kingmaker to its factory settings, clearing all user data, presets, expression mappings and custom effect types, use the Neuro App and choose the Factory Reset option.

Noise

Power source: Ensure that the proper power supply is being used.

Near noise source: Move pedal away from power supplies and other equipment.

Other equipment: Remove other effects from signal chain; see if noise persists.

Bad cables: Swap out audio cables.

USB ground loop: When connected to a computer using a USB cable, noise can appear in the audio signal. This usually results from ground loop noise due to the Kingmaker and computer running on separate power supplies. In the case of laptops, the noise can often be mitigated by disconnecting the computer's power supply and running it on a battery. External display monitors are often the primary source of noise, and powering down monitors can also resolve noise issues. Unfortunately, some USB hubs and motherboards are inherently noisy, so it's not always possible to eliminate USB noise entirely.

Hot Hand Doesn't Work

Low power: Ensure that the proper power supply is being used.

Not calibrated properly: Calibrate the Hot Hand. See the [Hot Hand Input](#) section for more details.

Not connected properly: Check Hot Hand connections.

Unit Appears Dead / No LEDs Lit

Effect is bypassed: Press the footswitch to enable the effect and see if the main LED turns on.

Wrong power supply: Use correct power supply. See the [DC 9V \(Power\)](#) section for more details.

Corroded power cable plug: Check power plug for corrosion on sleeve. Swap out power supply if necessary.

Hard Reset

Hard Reset - Restore Original Firmware: In cases where the Kingmaker stops working and none of the other troubleshooting methods are successful, a hard reset may be beneficial. This process reverts the unit fully to its original factory firmware, so it should only be used when all else fails. A hard reset will clear all user data, presets, expression mappings, and custom effect types, and it will roll back any firmware updates that you may have made on the Kingmaker since purchasing it. In order to perform a Hard Reset, follow these steps:

- Disconnect the Kingmaker's power supply. And disconnect any audio cables from its inputs and outputs.
- Press and hold the CONTROL INPUT BUTTON and the ON/OFF FOOTSWITCH at the same time.

- While continuing to hold the CONTROL INPUT BUTTON and the ON/OFF FOOTSWITCH, plug in the power supply.
- Wait until the ENGAGE/BYPASS LED is lit red. At this point, you can stop pressing the CONTROL INPUT BUTTON and the ON/OFF FOOTSWITCH.
- Move the EFFECT SELECTOR SWITCH to each of its three positions, left, right, and center.
- Now, the ENGAGE/BYPASS LED should turn green/red and the CONTROL LED should turn off.
- Finally, press the ON/OFF FOOTSWITCH. The hard reset operation will commence. When the hard reset is complete, the Kingmaker should reset and power up in its factory default mode.

Frequently Asked Questions

How do I change the routing mode for my pedal without changing anything about the sounds?

- Connect the Neuro App cable and go to the Sound Editor in the app.
- Flip the EFFECT SELECTOR SWITCH on the hardware to the left position.
- In the app, go to the I/O Routing Option (bottom of the list), select it, and the desired routing mode. Then tap Done. You should see the CONTROL LED blink when the message is received.
- Tap the BURN button in the Neuro App. This opens a menu for burning locations.
- Select "Toggle Switch Left". This burns any changes you made into memory. Since you only changed the I/O Routing mode, that will be the only thing that is changed. The rest of the parameters for that sound will remain unchanged.
- Repeat these steps for the middle switch position and the right switch position.

What kind of instruments can I connect to the Kingmaker's inputs?

The Kingmaker's audio inputs are high impedance ($\sim 1\text{ M}\Omega$) and they can accept high impedance signal sources like guitars/basses with passive pickups, as well as low impedance sources like line-level audio circuits, guitars/basses with active pickups, electronic keyboards, or mixer outputs. The input circuit can handle signals ranging up to 5.6 Volts, peak-to-peak.

Can I power the Kingmaker directly over USB, without using the 9 Volt supply?

No. USB provides 5 Volts, but the Kingmaker needs 9 Volts, so the Kingmaker cannot be powered directly from USB. Make sure that you have plugged in the included 9V DC power supply when connecting to the Kingmaker's USB port.

When connecting the Kingmaker to a recording interface or mixer, should I use a Lo-Z (microphone) or Hi-Z (line / instrument) input?

The Kingmaker's output will be low impedance when the effect is active or in buffered bypass mode, but it will be high impedance when using true bypass mode and a guitar with passive pickups. Therefore, it is recommended that you use a high impedance (Hi-Z) input on your recording interface or mixer to avoid signal loss.

Why doesn't the Kingmaker respond to MIDI messages being sent to it?

By default, the Kingmaker should respond to MIDI continuous controller messages on channel 1 (in technical terms, this means that the lower 4 bits in the command byte of MIDI messages should be 0000 in binary or 0 in hexadecimal). The Kingmaker's MIDI channel can be configured using the

Neuro App. Channel numbers in MIDI use zero-based counting, so MIDI channel 1 is described as 0 in hexadecimal, MIDI channel 2 is described as 1 in hexadecimal, and so on, concluding with MIDI channel 16, which is described as F in hexadecimal. A continuous controller message starts with a hexadecimal B and is followed by the channel number (0 through F). So, the command byte from your MIDI controller should be formatted as shown in the following table:

MIDI Channel (Decimal)	1	2	3	4	5	6	7	8	9	10	11	12	13	14	15	16
CC Command Byte (Hex)	B0	B1	B2	B3	B4	B5	B6	B7	B8	B9	BA	BB	BC	BD	BE	BF

Each continuous controller command byte is followed by two bytes, the CC number and the value. So, each CC message consists of a total of three bytes. If the Kingmaker is not responding to MIDI, make sure that your MIDI controller is properly configured and sending messages in the format described above.

How do I enable extended effect types via MIDI?

Refer to the [MIDI Learn](#) section to map a MIDI continuous controller to the Effect Type switch. Then, send a CC message with one of the following values to enable a certain effect type:

CC Value	Effect Type
0	Tube Drive
1	Smooth Tube
2	Power Stage
3	Crunch Tube
4	TS9000
5	Big Pi
6	El Raton
7	Fuzz Façade
8	Bender
9	Metal
10	Octave Fuzz
11	Gated Fuzz
12	Bass Tube Drive
13	Bass Smooth Tube
14	Bass Power Stage
15	Bass Crunch Tube
16	Bass TS9000
17	Bass Big Pi
18	Bass El Raton
19	Bass Fuzz Façade
20	Bass Bender
21	Bass Metal
22	Bass Octave Fuzz

23	Bass Gated Fuzz
24	Tone Drive

Additional effect types may become available in future updates.

Rubber Feet

The Kingmaker comes standard with a flat aluminum bottom, making it easy to apply Velcro and mount to a pedalboard. Additionally, adhesive rubber feet are included in the Kingmaker’s box. Applying the rubber feet to the Kingmaker can help prevent it from sliding on flat surfaces such as a hardwood floor.

Waste Disposal Notes



If possible, dispose of the device at an electronics recycling center. Do not dispose of the device with the household waste.

For full compliance with EN 61000-4-6 standard, input cable must be less than 3 meters in length.

Warranty

Limited Transferrable Warranty

Source Audio, LLC (hereinafter “Source Audio”) warrants that your new Source Audio One Series Kingmaker Fuzz, when purchased at an authorized Source Audio dealer in the United States of America (“USA”), shall be free from defects in materials and workmanship under normal use for a period of two (2) years from the date of purchase by the original purchaser. Please contact your dealer for information on warranty and service outside of the USA.

Under this Limited Warranty, Source Audio’s sole obligation and the purchaser’s sole remedy shall be repair, replacement, or upgrade, at Source Audio’s sole discretion, of any product that, if properly used and maintained, proves to be defective upon inspection by Source Audio. Source Audio reserves the right to update any unit returned for repair and to change or improve the design of the product at any time without notice. Source Audio reserves the right to use reconditioned parts and assemblies as warranty replacements for authorized repairs. Any product repaired, replaced, or upgraded pursuant to this Limited Warranty will be warranted for the remainder of the original warranty period.

This Limited Warranty is extended to the original retail purchaser. This Limited Warranty can be transferred to anyone who may subsequently purchase this product provided that such transfer is made within the applicable warranty period and Source Audio is provided with all of the following information: (i) all warranty registration information (as set forth on the registration card) for the new owner, (ii) proof of the transfer, within thirty (30) days of the transfer, and (iii) a photocopy of the original sales receipt. Warranty coverage shall be determined by Source Audio in its sole discretion. This is your sole warranty. Source Audio does not authorize and third party, including any

dealer or sales representatives, to assume any liability on behalf of Source Audio or to make any warranty on behalf of Source Audio.

Warranty Information

Source Audio may, at its option, require proof of the original purchase date in the form of a dated copy of the original authorized dealer's invoice or sales receipt. Service and repairs of Source Audio products are to be performed only at the Source Audio factory or a Source Audio authorized service center. Prior to service or repair under this Limited Warranty, the purchaser must request from Source Audio a return authorization, which is available at:

Source Audio LLC
120 Cummings Park, Woburn, MA 01801
(781) 932-8080 or at www.sourceaudio.net

Unauthorized service, repair, or modification will void this Limited Warranty.

Disclaimer and Limitation of Warranty

Do not open the effects pedal under any circumstance. This will void the warranty.

The foregoing limited warranty is the only warranty given by Source Audio and is in lieu of all other warranties. All implied warranties, including warranties of merchantability and fitness for any particular purpose, exceeding the specific provisions of this limited warranty, are hereby disclaimed and excluded from this limited warranty. Upon expiration of the applicable express warranty period, Source Audio shall have no further warranty obligation of any kind, express or implied. Source Audio shall in no event be liable for any special, incidental, or consequential damages suffered by the purchaser or any third party, including without limitation, damages for loss of profits or business or damages resulting from use or performance of the product, whether in contract or in tort. Source Audio shall not be liable for any expenses, claims, or suits arising out of or relating to any of the foregoing. Some states do not allow the exclusion or limitation of implied warranties so some of the above limitations and exclusions may not apply to you. This Limited Warranty gives you specific legal rights, and you may also have other rights, which vary, from state to state. This Limited Warranty only applies to products sold and used in the USA. Source Audio shall not be liable for damages or loss resulting from the negligent or intentional acts of the shipper or its contracted affiliates. You should contact the shipper for proper claims procedures in the event of damage or loss resulting from shipment.

Version History

February 19, 2016: Initial Release



©Source Audio LLC | 120 Cummings Park, Woburn, MA 01801 | www.sourceaudio.net